



iJiNUS
GROUPE CLAIRE

LNR06V4



Data logger with radar level sensor

User guide

User guide: Version 06

Publication date 04/2026

Documentation valid from Avelour software version 7.4

Table of Contents

1. Document information	9
1.1. Background	9
1.2. Symbols used	9
2. Product marking information	10
3. Safety	11
3.1. General instructions	11
3.2. Note for users in Canada	11
4. Description	12
4.1. Principle of operation	12
4.2. Composition	13
4.3. Technical specifications	14
4.3.1. LNR logger	14
4.3.2. Dimensions	15
4.3.3. M12 8-pin connector	16
4.4. EU Declaration of Conformity	17
5. Commissioning	18
5.1. Inserting the SIM card	18
5.1.1. Releasing electrical charges	18
5.1.2. Inserting a SIM card	18
5.2. Assembling the modem 2G / 4G kit	19
6. Power supply	21
6.1. Using a mains power supply	21
6.2. Using a power pack	21
7. Connections	22
7.1. Connect one or more external sensors	22
7.2. Wiring	22
7.2.1. Flow meter wiring in Modbus protocol	23
Krohne Waterflux 3070	23
ABB Aqua master 4	23
Badger M5000	24
MAG8000	24
Octave	25
Proline Promag W 800	26
7.2.2. C4E physical-chemical sensor	27
7.2.3. CTZN physical-chemical sensor	27

7.2.4. Redox Annulaire digital physical-chemical ring sensor	29
7.2.5. NTU Physical-chemical sensor	29
7.2.6. OPTOD physical-chemical sensor	29
7.2.7. PHEHT physical-chemical sensor	30
7.2.8. Overflow detector wiring	30
<i>Connections</i>	30
<i>Wiring - Bare wire version</i>	32
<i>M8-Male connectorised version</i>	33
8. Installation	34
8.1. Installation of a radar sensor	34
8.1.1. Positioning a radar sensor	34
<i>Radar beam diameter</i>	34
<i>Measuring over a main sewer</i>	35
<i>Positioning according to quality of water surface</i>	36
8.1.2. Installation with mounting kit	36
<i>Installing a clamp</i>	38
<i>Mounting the logger</i>	38
8.1.3. Installing an angle rebate	38
8.1.4. Installation of a remote antenna	41
8.2. Installing the OSRAI system	43
8.2.1. Principle	43
8.2.2. Site selection	43
<i>Main sewer</i>	43
<i>Manholes</i>	43
<i>Upstream requirement</i>	44
<i>Downstream requirement</i>	44
8.2.3. Choice of contraction	44
<i>Pipe diameter phi 200 mm</i>	44
<i>Pipe diameter phi 250 mm</i>	44
<i>Pipe diameter phi 300 mm</i>	44
8.2.4. Positioning and installation of the measuring system	44
8.2.5. Installing the contraction	46
8.3. Installation of a tipping bucket rain gauge	47
8.3.1. Recommendations	47
8.3.2. Calibration	47
<i>Bucket zeroing</i>	47
<i>Measuring a volume of water</i>	47
8.3.3. Checks	48
8.4. Installation of an overflow detector	49
8.4.1. Positioning	49
8.4.2. Attachment using kit	49
8.4.3. Examples of installation	50
9. Configuration on Avelour	51
9.1. Equipment required	51
9.2. Installing the Avelour software	51
9.3. Connecting to a logger	51
9.4. Protect the logger using a password	54

9.4.1. Activation	54
9.4.2. Password Format	55
9.4.3. Forgotten password	55
9.5. General configuration information	55
9.6. Configuring a measurement recording	57
9.6.1. Radar Water height	57
<i>Principle</i>	57
<i>Radar calibration</i>	57
<i>Water level measurement configuration</i>	64
<i>Mapping table between DataID, channel & data</i>	67
9.6.2. Radar Water height -> Flow	67
<i>Principle</i>	67
<i>Radar calibration</i>	68
<i>Water level measurement configuration</i>	75
<i>Flow</i>	78
<i>Volume</i>	79
<i>Sampler enslaving</i>	79
<i>Configuration summary</i>	80
<i>Mapping table between DataID, channel & data</i>	80
9.6.3. Radar Water height -> OSRAI Flow	81
<i>Principle</i>	81
<i>Radar calibration</i>	81
<i>Water level measurement configuration</i>	88
<i>Configuration of Osrai flow installation</i>	91
<i>Volume</i>	92
<i>Configuration summary</i>	92
<i>Mapping table between DataID, channel & data</i>	92
9.6.4. Radar Water height + external velocity -> Flow	94
<i>Principle</i>	94
<i>Radar calibration</i>	94
<i>Water level measurement configuration</i>	101
<i>Velocity - Case of a sensor connected to another logger</i>	104
<i>Flow - Case of a sensor connected directly to the LNR</i>	104
<i>Volume</i>	104
<i>Configuration summary</i>	105
<i>Mapping table between DataID, channel & data</i>	105
9.6.5. Radar Water height + RAVEN-EYE Radar	106
<i>Principle</i>	106
<i>Prerequisite</i>	106
<i>Water level configuration</i>	107
<i>Mapping table between DataID, channel & data</i>	117
9.6.6. Radar Water height + wired overflow detector	117
<i>Water level measurement configuration</i>	118
<i>Wired overflow detector</i>	127
<i>Flow</i>	128
<i>Volume</i>	129
<i>Configuration summary</i>	129
<i>Mapping table between DataID, channel & data</i>	129
9.6.7. Intelligent low-power Doppler measurement (Ubertone sensor)	131
<i>Principle</i>	131
<i>Configuration</i>	131
<i>Mapping table between DataID, channel & data</i>	134
9.6.8. Water height measurement: Low-profile Doppler (IAVL sensor)	136
<i>Principle</i>	136
<i>Configuration</i>	136
<i>Mapping table between DataID, channel & data</i>	140
9.6.9. Doppler velocity measurement (Nivus sensor)	142

Principle	142
Configuration	142
9.6.10. Doppler velocity and overflow measurement (Nivus sensor)	144
Principle	144
Configuration	144
9.6.11. Flow measurement: Doppler speed + built-in piezoresistive height (Nivus sensor)	146
Principle	146
Configuration	146
Combined Doppler speed/piezoresistive height sensor	146
9.6.12. Physical-chemical measurement	149
Principle	149
Configuration	149
Mapping table between DataID, channel & data	154
9.6.13. Conductivity measurement (B&C sensor)	157
Principle	157
Configuration	157
9.6.14. Measurement using an ISCO signature flow meter	159
Principle	159
Configuration	159
Mapping table between DataID, channel & data	160
9.6.15. Configure a wired modbus display on push-button	163
Operation	163
Display configuration	163
Configuration summary	163
9.6.16. Wired overflow detector	164
Principle	164
Configuration	164
9.6.17. Modbus master	167
Principle	167
Configuration	167
9.6.18. Measurement using the Modbus protocol : Slave mode	170
Principle	170
Settings	170
9.6.19. Measurement via DI/CO input	172
Principle	172
Configuration	172
Mapping table between DataID, channel & data	172
9.6.20. Modbus flow meter	174
Principle	174
Flowmeter wiring	174
Configuration	174
9.6.21. Recording of bucket toggles	183
Principle	183
Configuration	183
Configuration summary	183
Recording of bucket toggles	183
9.6.22. Cumulative Rainfall	185
Principle	185
Configuration	185
Rain gauge configuration	185
Mapping table between DataID, channel & data	186
9.6.23. Measurement for pump station management	187
Principle	187
Configuration	188
Mapping table between DataID, channel & data	189
9.6.24. Flow measurement using a 100 Hz velocity counter	191
Principle	191

Configuration	191
Mapping table between DataID, channel & data	193
9.7. Configuring the sending data	196
9.7.1. Technologies used	196
9.7.2. Signal quality: Mobile Signal Strength Value	196
9.7.3. Configuring the modem of the communication card	196
Technology to use	197
PIN code	198
APN	198
Priority operator (Multi-operator SIM)	198
Program modem	199
9.7.4. Check network quality: Modem diagnostics	200
9.7.5. Data sending in FTP(s)	201
9.7.6. Data sending in Http(s)	204
Configuration	204
9.7.7. Data sending in MQTT(s)	207
Principle	207
Message format	207
Activation	207
Configuration	208
Quality of Service (advanced setting)	208
Format Almagora	208
Topic (advanced setting)	209
9.7.8. Advanced internet connection settings	210
PPP	210
SNTP	210
Custom DNS server	210
9.7.9. Certificate management	211
Generalities	211
Managing certificate	211
9.7.10. Data sending via SMS	213
9.7.11. Data sending in LoRaWAN	215
Transmission cycle	215
Login information	215
Test data transmission	215
Advanced settings	216
Expert mode	216
Integration of a logger on Orange Live objects	216
Integration of a logger on WIOTYS	217
Integration of a logger on THE THINGS	217
9.7.12. Configure an alarm	219
9.7.13. Sending an alert SMS	219
9.8. Test data transmission before commissioning	220
9.8.1. Objective	220
9.8.2. Test procedure	220
9.8.3. Troubleshooting	220
9.9. Sending logger configuration using server (remote configuration)	221
9.9.1. Principle	221
9.9.2. Configuring server access on Avelour	222
FTP	222
HTTP	222
MQTT	223
9.9.3. Configuring data sending	224
FTP	224

HTTP	224
MQTT	225
9.9.4. Retrieving a configuration via internet	225
9.9.5. Edit and send the configuration remotely	227
9.9.6. Do a remote configuration of a logger without a communication card	228
9.10. Power supply configuration	229
9.10.1. Lithium battery	230
9.10.2. Lead-acid battery	231
9.11. Set time zone	232
9.12. Pairing one or more loggers	232
9.13. Check the status of data recording and transmission	233
9.14. Save the configuration to the logger	234
9.15. Visualize measured values in real time	235
9.16. Stop a recording in progress	235
9.17. Disconnect from the logger	236
9.18. Managing a configuration	236
9.18.1. View a configuration file	236
9.18.2. Archive a file	236
9.18.3. Create a configuration template	237
9.18.4. Apply a configuration template	237
10. Data management on Avelour	239
10.1. Retrieving saved data	239
10.2. Retrieve diagnostic echoes	240
10.3. Retrieve data from auxiliary memory	243
10.4. Create a new calculated value	244
10.5. Data graph	245
10.5.1. Display tools on Avelour	245
10.5.2. Show data graph	245
10.5.3. Customize the graph display	246
10.5.4. Hide the display of data on the graph	247
10.5.5. Display values in table form	247
10.6. Export retrieved data	249
10.7. Delete data recorded on the logger	249
11. Maintenance	251
11.1. Replacing the battery	251
11.2. Firmware update	253
11.3. Remote firmware update	254
11.4. Reset the logger (factory settings)	255
11.4.1. Wiji reset	255
11.4.2. Manual reset	256

Chapitre 1. Document information

1.1. Background

This user guide contains all the information required to install, connect and commission the unit, as well as important notes concerning maintenance. It is therefore essential to read it before commissioning any Ijinus equipment.

1.2. Symbols used



This symbol indicates a situation or use that may result in damage, fault or equipment malfunction.



This symbol indicates additional information useful for the understanding and correct use of the equipment.



This symbol indicates a prerequisite for performing a task.

Chapter 2. Product marking information



The CE mark indicates that the product complies with current European directives.



Consult the user manual before using the product.



Do not dispose of this product in household waste. The product must be sent to a specific collection point, or collected by an organization that will ensure its further processing.



Direct current

Meaning of symbols

Chapter 3. Safety

3.1. General instructions

This document presents a number of operations and programming to be performed on a data logger, a sensor or an accessory supplied by Ijinus. These operations must only be performed by personnel qualified to use Ijinus products. The information provided in this user guide only ensures operational safety if the equipment is used correctly. Performing any work on the device requires the use of appropriate personal protective equipment. Below we have provided a non-exhaustive list of recommendations to apply to ensure the safety of Ijinus data logger users:

- Only use batteries specified by Ijinus.
- Risk of fire or burns with lithium batteries: do not short-circuit, recharge, puncture, incinerate, crush, immerse, fully discharge or expose the batteries supplied by Ijinus to temperatures above the operating temperature range.
- Do not shake the sensor.
- Do not physically modify the sensor.
- Do not clean the device with an aggressive product, particularly Acetone and similar.
- The device contains components that may be damaged or destroyed by electrostatic discharge. Release any electrostatic charge from your body before opening the device and handling it. To do this, touch a grounded metal surface. Ijinus assumes no liability for damage resulting from incorrect or non-compliant use.

3.2. Note for users in Canada

This device complies with Industry Canada's RSS for license-exempt radio equipment.

The operation is authorized subject to the following two conditions: (1) it must not cause interference, and (2) the user of the device must be prepared to accept any radio interference received, even if this interference is likely to compromise the operation of the device.

In accordance with Industry Canada regulations, this radio transmitter may be operated with an antenna of a type and maximum gain (or less) approved for the transmitter by Industry Canada.

To reduce the risk of radio interference to other users, the type of antenna and its gain must be chosen so that the equivalent isotropically radiated power (e.i.r.p.) does not exceed the intensity required to establish satisfactory communication.

This device complies with the RF personal exposure requirements defined by Industry Canada. This device must be installed so as to provide a separation distance of at least 20 cm from the user, and must not be installed near or used in conjunction with any other antenna or transmitter.

If the antenna is removable (RSS-GEN): This device has been designed to work with the antennas listed below, with a maximum gain of 0 dBi. Antennas not included in this list, or with a gain exceeding 0 dBi, are strictly forbidden for use with this device. The required antenna impedance is 50 Ω . List of acceptable antennae:

- IJINUS
- BOE type

Chapter 4. Description

4.1. Principle of operation

Ijinus loggers are designed to be standalone units powered by a lithium battery. They log data transmitted by the equipment to which they are connected. A mobile programming unit (M0C00001) or a Wiji USB dongle (WIJKEY-8) can be used to connect to the logger by radio (Wiji protocol), configure it and retrieve data locally. Depending on the logger model, it can be fitted with a modem, enabling data to be transmitted automatically and wirelessly to our Web platform www.ijitrack.com, or to a client server.

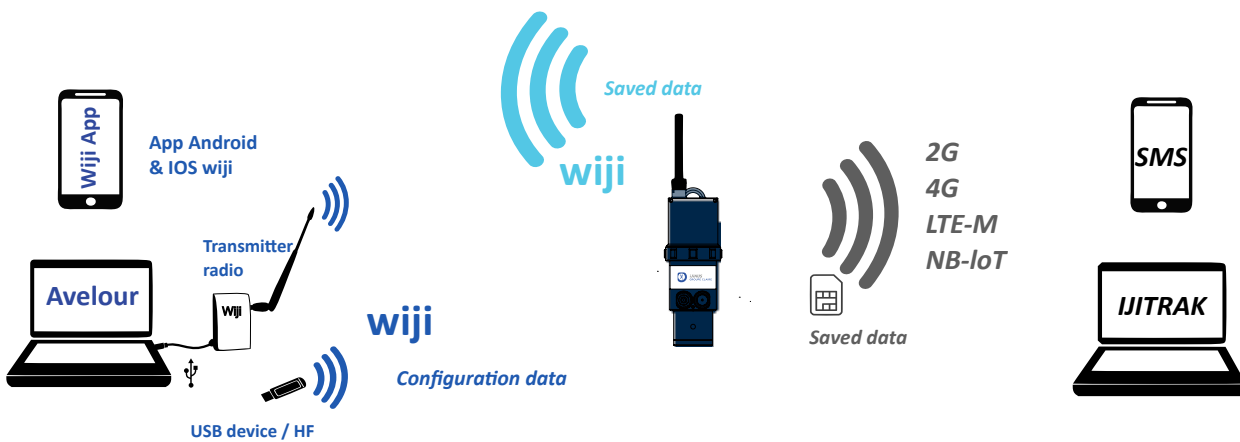

4.2. Composition

The logger is powered by an internal battery. The logger housing has an IP68 waterproof rating (can be submerged in 10 meters of water for 30 days). The logger is equipped with a radar sensor for distance measurements, ranging from 0.15 meters up to 6 meters.

A radio access point, also called a programming antenna, must be used to program the logger. This access point can also be used for local, wireless (within a maximum of a few dozen meters between the logger and the access point connected to the USB port of a computer) download of data measured by the built-in sensor, or by an external sensor connected to the logger via the M12 8-pin connector (A).

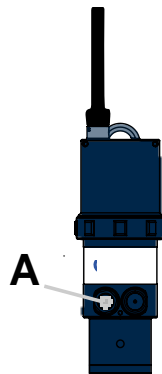

LNR06V4 logger



3.6 V 34 Ah non-rechargeable lithium battery



Programming antenna



Remote antenna (optional)





Mounting kit: 2 x mounting plates
+ 1 x bracket + 4 nuts and bolts



Connection cable (if required)

4.3. Technical specifications

4.3.1. LNR logger

Characteristics	LNR06V4	
Measuring distance	0.15 m - 10 meters	
Resolution	2,000 points over the measuring range with a minimum of 1 mm (example: ± 4 mm for a distance measurement of 6.0 m)	
Measurement uncertainty	$\pm 0.2\%$ of distance measurement with a minimum of ± 2 mm	
Communication	<ul style="list-style-type: none"> • HF radio (869.2 MHz) • 2G / 4G (LTE M / NB IoT) Protocols: FTPS, HTTPS, COAP and MQTTS	<ul style="list-style-type: none"> • LoRaWAN: Europe 863-870 MHz (SF12 for RX2) LoRaWAN Specification 1.0.2
Radio Range	100 meters in open field (Wiji protocol)	
Storage capacity	500,000 measurements	
Radio concentrator function	Yes	
Radio / mobile antenna	<ul style="list-style-type: none"> • Internal or external radio 	<ul style="list-style-type: none"> • Internal or external mobile
Temperature range	-20°C - 70°C	
Sensor material	PA12	
Ingress protection	IP68: 1 bar for 1 month (only if using an Ijinus mounting kit; ref: H0T00053 or H0T00060)	
Power supply	Lithium battery: 3.6 V - 34 Ah	
Configuration	Wireless programming kit (PN: M0C00001) comprising AVELOUR software, cable and antenna	
Technology	<ul style="list-style-type: none"> • 60 GHz radar imaging • eKo ® algorithm 	<ul style="list-style-type: none"> • LAMY ® filtering
ATEX zone 2 certifications 	II 3G Ex ic ec IIB T4 Gc Ambient temp: -20 °C - 60 °C	Certifications 

4.3.2. Dimensions

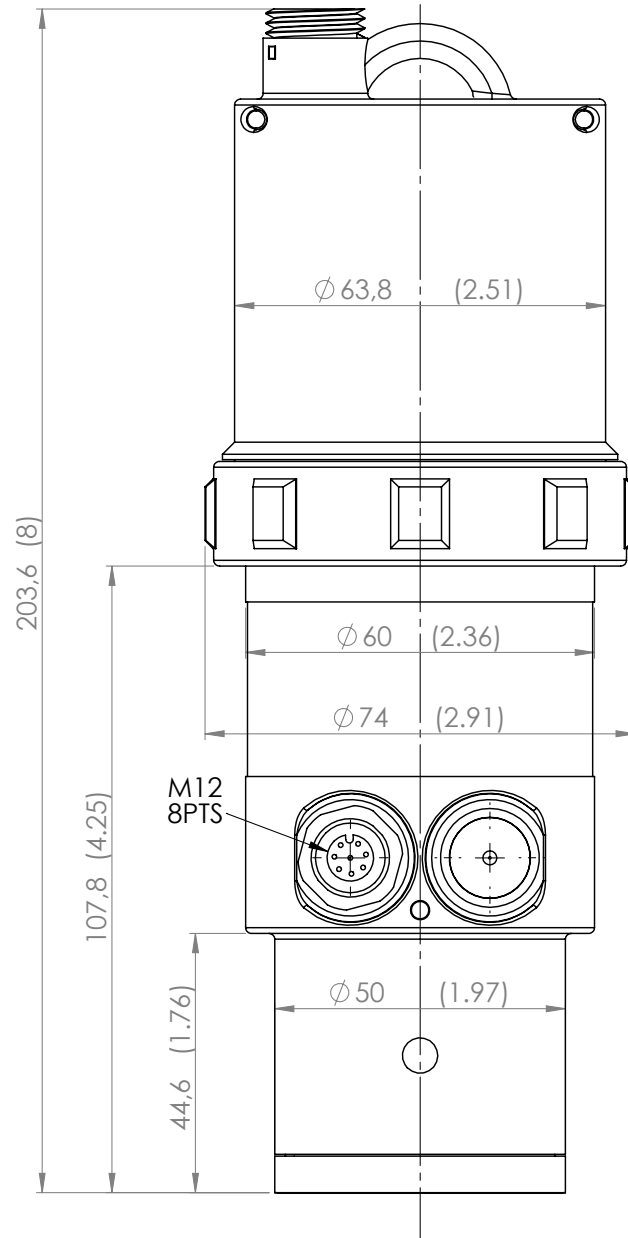

4.3.3. M12 8-pin connector

Wiring

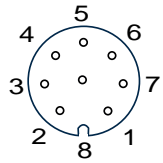

Female

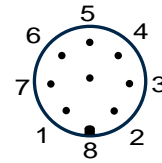

Male

Cable color	White ○	Brown ●	Green ●	Yellow ●	Grey ●	Pink ●	Blue ●	Red ●
8-pin connector	1	2	3	4	5	6	7	8
Designation	Vin	GND	Vout	Mod-bus	Mod-bus	Input	Input	Output
Characteristic	External power supply or battery (5V - 30V)	Ground	Power supply 5V - 18V * (from internal battery) or Switch Vout = Vin	RS485 H	RS485 L	Digital 1 / Metering 1 100 Hz	Digital 2 / Metering 2 100 Hz	Contact Grounding
Type	Power supply input		Power supply output	High	Low	Digital	Digital	Open drain (1A/30V)

* 1.8 W maximum on the V_{out} if the connected sensor is powered by the internal battery (voltage adjustable via software).

4.4. EU Declaration of Conformity

IJINUS - 25 ZA de Kervidanou 3 - 29300 MELLAC - FRANCE

Declares, under its sole responsibility, that the equipment designated below:

Level sensors of the LNU and LNR range, data loggers of the Blue, LOG, LP and LOGAZ - V4 series, overflow detectors of the CSC series (only connected to an Ijinus data logger of the LNU, LNR, Blue or LOG series)

- meet the essential requirements of the Directives:
 - LVD 2014/35/EU¹, EMC 2014/30/EU², RED 2014/53/EU³, RoHS 2011/65/EU⁴

For these purposes, the following standards have been taken into account:

¹ EN 62479 (2010)

² EN 301 489-1.3 (2016), EN 301 489-52 (2016)*

³ EN 300 220 -1.2 (2017), EN 301511 (2016)*, EN 301908-1,2,3 (2016)*

⁴ EN 50581 (2013)

* if GSM modem used

- 2014/34/EU on equipment for use in explosive atmospheres

For these purposes, the following standards have been taken into account:

EN 60079-0 (2013)	General requirements
EN 60079-11 (2012)	Equipment protection by intrinsic safety "i"
EN 60079-7 (2016)	Equipment protection by increased safety "e"

The equipment markings must include the following information:

This equipment is suitable for use in ATEX zone 2.



II 3 G

Ex ic ec IIB T4 Gc

Tamb: -20°C...+60°C

Provided that they are used in accordance with their intended purpose, that the installation complies with the regulations and standards in force as well as the manufacturer's recommendations, in particular concerning the risk of electrostatic charge and the use of battery packs supplied solely by Ijinus.

- Complies with IP68 protection rating (submersion to 10 meters for 30 days) according to EN 60529:1992 + A1:2000

Marc MOREAU - Chief Operating Officer



Date: 26/08/2024

Chapter 5. Commissioning

If the logger does not have a communication PCB, there is no need to open the housing as the internal battery is already connected to the PCB. The logger is therefore operational immediately.

iJinus loggers do not require activation, as they listen for a radio connection request from a radio access point or another logger every 10 seconds.

If the logger has a communication PCB (LTE option, for example), then the SIM card must be inserted in its holder, see paragraph [Inserting the SIM card](#).

5.1. Inserting the SIM card

Loggers with a communication PCB require a SIM card to operate. The SIM card holder is located on the communication PCB.

5.1.1. Releasing electrical charges

Our sensors and loggers contain components that can be damaged by electrostatic discharge.



It is imperative to release any static electricity from your body before opening the product.

To do so:

- Touch a grounded surface such as an electrical cabinet enclosure

5.1.2. Inserting a SIM card



Avoid leaving the logger open for too long (just a few minutes), because if the desiccant bag absorbs too much moisture, it will no longer be effective and will turn green.



Removing the cover can be difficult due to the gasket. The cover antenna is connected to the circuit board, so to avoid pulling out the circuit board when opening the logger, we strongly advise you to open the logger as follows:

- Partially unscrew the clamping ring (A) (approx. 2 turns).
- Pull on the cover until it is partially extracted, secured by the clamping ring.
- Unscrew the clamping ring completely to fully remove the cover.
- Insert the SIM card into the SIM card holder, ensuring that it is inserted with the beveled side to the top right.
- Check the color of the desiccant bags and replace them if they are green.



- Replace the cover as far as it will go, taking care to fit the insertion notch into the coded hole (B).



- Retighten the clamping ring (A).

5.2. Assembling the modem 2G / 4G kit

Unscrew the clamping ring and remove the cover



Put the communication card



Replace the desiccant sachet with a new one.



Insert the male connector (A) of the antenna cable into the hole (B) and connect it to the card via the female connector (C)

Replace the cover, pushing it all the way in, taking care to ensure that the insertion notch is correctly aligned with the pin (D)

Screw the antenna to the cover

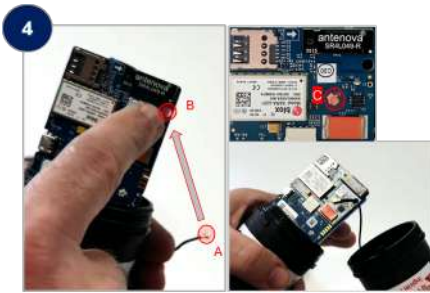

Chapter 6. Power supply

6.1. Using a mains power supply

IjInUS loggers can be powered from an external mains supply. The voltage delivered to the logger must be between 8 V and 30 V.



You must use a transformer (e.g. 220 V / 24 V) that is correctly grounded. In the absence of a ground connection, several malfunctions may occur (metering problems, measurement disturbances, etc.) due to disturbances caused by the mains power supply.

- To configure the logger, please refer to paragraph [Power supply configuration](#).

6.2. Using a power pack

Two main types of batteries are available from IjInUS:

- Rechargeable lead-acid battery.
- Non-rechargeable lithium battery.

Lead-acid batteries have a voltage of 12 V.

Two types of lithium batteries are available: 10.8 V and 14.4 V.



Do not use a 14.4 V battery on a sensor other than the Nivus Doppler.

Applying a voltage above 13 V to an Aqualabo sensor will disable the sensor.

- To configure the logger, please refer to paragraph [Power supply configuration](#).

Chapter 7. Connections

7.1. Connect one or more external sensors

The logger has an M12 8-pin socket for connecting different types of sensors or equipment.

To connect a sensor to the logger's M12 8-pin socket:

- Remove the protective cap, then screw the sensor onto the connector.



To ensure an IP68 waterproof seal on the connector, ensure that the connector is correctly screwed onto the base unit. To do this, tighten the connector to the base as far as possible, by hand and without tools.

If several sensors are to be connected to the logger, a junction box is available (part no. G0D00050) for IP68 compliant connection (provided all connectors are tightened correctly).

- Connect the male connector of the junction box to the logger base socket, then 3 sockets are then available on the junction box to connect sensors.

7.2. Wiring

Wiring

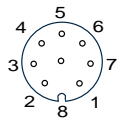

Female view

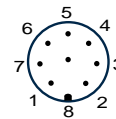

Male view

Cable color	White	Brown	Green	Yellow	Grey	Pink	Blue	Red
8-pin connector	1	2	3	4	5	6	7	8
Designation	Vin	GND	Vout	Mod-bus	Mod-bus	Input	Input	Output
Characteristic	External power supply or battery (5V - 30V)	Ground	Power supply 5V - 18V * (from internal battery) or Switch Vout = Vin	RS485 H	RS485 L	Digital 1 / Metering 1 100 Hz	Digital 2 / Metering 2 100 Hz	Contact Grounding
Type	Power supply input		Power supply output	High	Low	Digital	Digital	Open drain (1A/30V)

* 1.8 W maximum on V_{out} if the connected sensor is powered by the internal battery (voltage adjustable via software).

7.2.1. Flow meter wiring in Modbus protocol



For the flowmeter to operate correctly in the Modbus protocol of communication (see paragraph [Measurement using the Modbus protocol : Slave mode](#), the ground must be wired.

Krohne Waterflux 3070

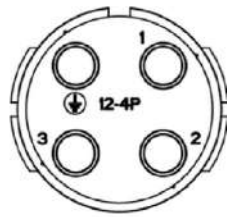

External side view connector

Flowmeter connector	wire Color	Function	M12 12 pts connector
1	Grey	RS485 L	8
2	Yellow	RS485 H	6
3	NC	/	NC
4	Brown	GND	1

ABB Aqua master 4

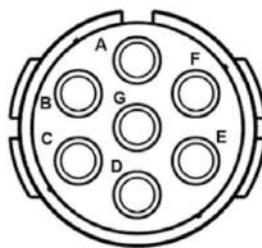

External side view connector

Flowmeter connector	Color	Function	M12 12 pts connector
A	Grey	RS485 L	8
B	Yellow	RS485 H	6
C	-	/	-
D	-	/	-
E	-	/	-
F	-	/	-
G	Brown	GND	1

Badger M5000

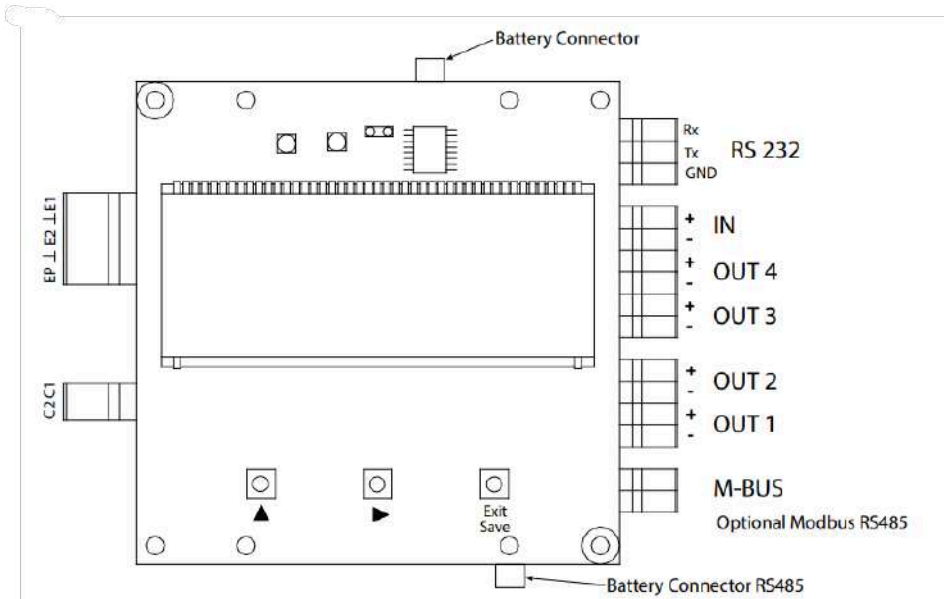

Input/Output	Description	Terminal
Output 1	Passive maximum 30V DC, 20 mA Maximum frequency 100 Hz	OUT1 (+) and (-)
Output 2	Passive maximum 30V DC, 20 mA Maximum frequency 100 Hz	OUT2 (+) and (-)
Output 3	Passive maximum 30V DC, 20 mA Maximum frequency 100 Hz	OUT3 (+) and (-)
Output 4	Passive maximum 30V DC, 20 mA Maximum frequency 100 Hz Can be used with digital input as an ADE interface.	OUT4 (+) and (-)
RS232	Modbus RTU	RxD, TxD, GND
IN	Digital input 3...35V DC	IN (+) and (-)
M-Bus ¹	M-Bus interface	No polarity
Optional Modbus RS485 ²	Modbus Interface Powered external 5...32V DC Optional internal by battery	GND, B-, A+, 12V

Flowmeter connector	Color	Function	M12 12 pts connector
A+	Yellow	RS485 H	4
B-	Grey	RS485 L	5
GND	Brown	GND	2

MAG8000

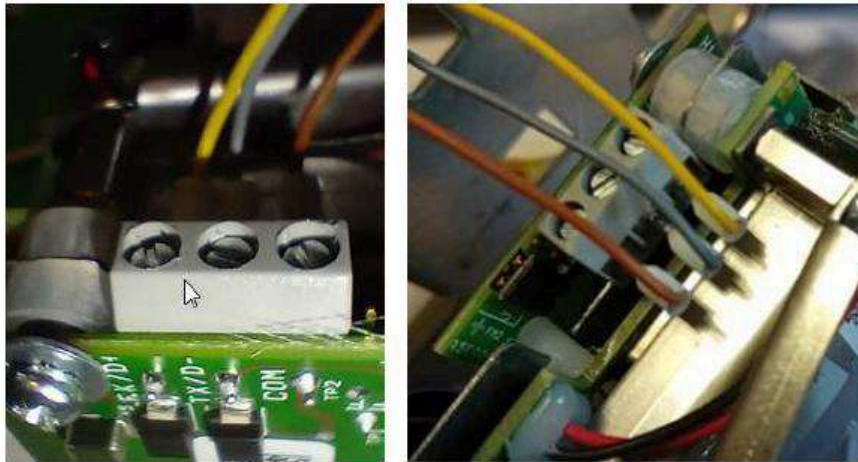

D+ : RS485 High (A) – IJINUS fil jaune
 D- : RS485 Low (B) - IJINUS fil gris
 COM : GND (fonctionne sans câblage de la masse) - IJINUS fil marron

Flowmeter connector	Color	Function	M12 12 pts connector
D+	Yellow	RS485 H	4
D-	Grey	RS485 L	5
GND	Brown	GND	2

Octave

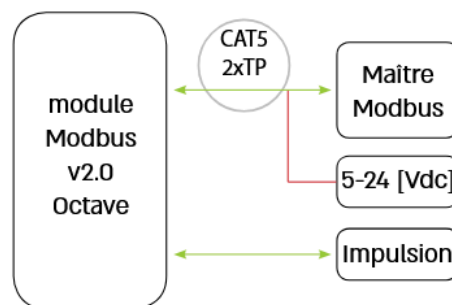

Câbles

	Fil	Fonction
ModBus	Bleu	D0/A/Tx+
	Blanc/Bleu	D1/B/Tx-
	Orange	5-24Vdc
	Blanc/Orange	Ground
Impulsion*	Rouge	Sortie impulsion
	Noir	Ground

MAG8000	Octave wire cable	IJINUS wire cable	Function	Pts connecteur M12 12 pts
Tx+	Blue	Yellow	RS485 H	4
Tx-	Blue/White	Grey	RS485 L	5
GND	Black	Brown	GND	2

Proline Promag W 800

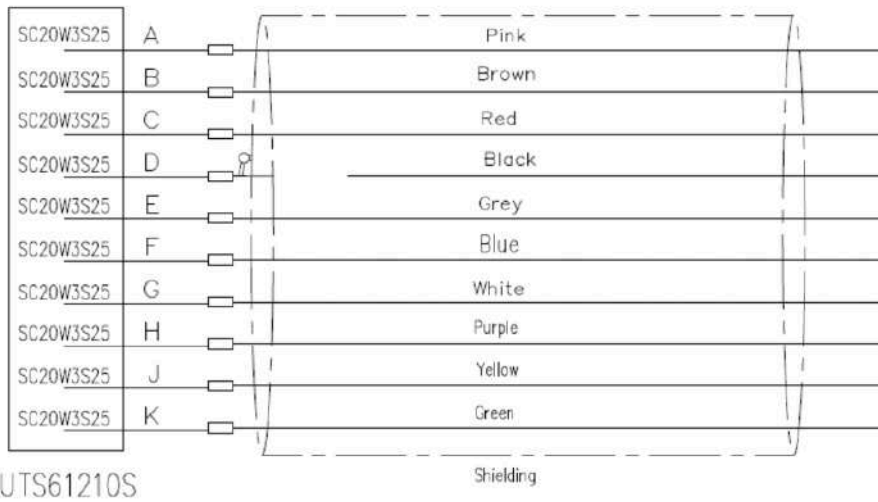
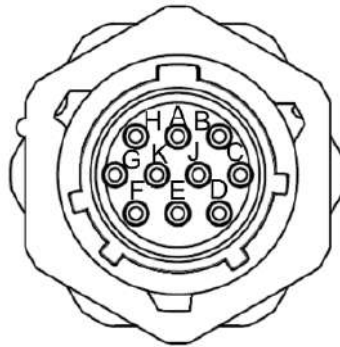

Broche	Fonction
A	PSO1+ (sortie impulsion/état 1+)
B	COM (potentiel de référence sorties impulsion/état)
C	NC (non connectée)
D	Terre
E	RS485_+ (Modbus B)
F	RS485_- (Modbus A)
G	PSO3+ (sortie impulsion/état 3+)
H	PSO2+ (sortie impulsion/état 2+)
J	NC (non connectée)
K	NC (non connectée)

MAG8000	IJINUS wire color	Fonction	M12 12 pts connector pts
E	Yellow	RS485 H	4
F	Grey	RS485 L	5
B	Brown	GND	2

7.2.2. C4E physical-chemical sensor

Wiring

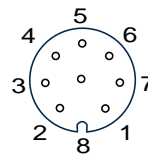

Female

Cable color	Black ●	Red ●	White ○	Green ●
8-pin connector	2	3	4	5
Designation	V_{in}	GND	Modbus	Modbus
Characteristic	Power supply	Ground	RS485 H	RS485 L

7.2.3. CTZN physical-chemical sensor

Wiring

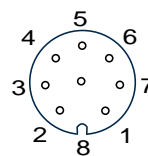

Female

Cable color	Black ●	Red ●	White ○	Green ●
8-pin connector	2	3	4	5

Designation	V _{in}	GND	Modbus	Modbus
Characteristic	Power supply	Ground	RS485 H	RS485 L

7.2.4. Redox Annulaire digital physical-chemical ring sensor

Wiring

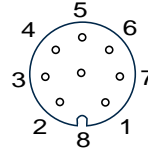

Female

Cable color	Black ●	Red ●	White ○		Green ●
8-pin connector	2	3	4		5
Designation	V _{in}	GND	Modbus		Modbus
Characteristic	Power supply	Ground	RS485 H		RS485 L

7.2.5. NTU Physical-chemical sensor

Wiring

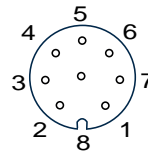

Female

Cable color	Black ●	Red ●	White ○		Green ●
8-pin connector	2	3	4		5
Designation	V _{in}	GND	Modbus		Modbus
Characteristic	Power supply	Ground	RS485 H		RS485 L

7.2.6. OPTOD physical-chemical sensor

Wiring

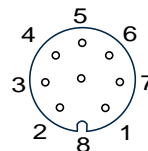

Female

Cable color	Black ●	Red ●	White ○		Green ●
8-pin connector	2	3	4		5
Designation	V _{in}	GND	Modbus		Modbus
Characteristic	Power supply	Ground	RS485 H		RS485 L

7.2.7. PHEHT physical-chemical sensor

Wiring

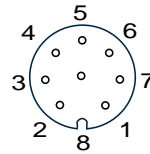

Female

Cable color	Black ●	Red ●	White ○		Green ●
8-pin connector	2	3	4		5
Designation	V _{in}	GND	Modbus		Modbus
Characteristic	Power supply	Ground	RS485 H		RS485 L

7.2.8. Overflow detector wiring

Connections



Making electrical connections is strictly reserved for authorized personnel.

Electrical connections must always be made with the power off.

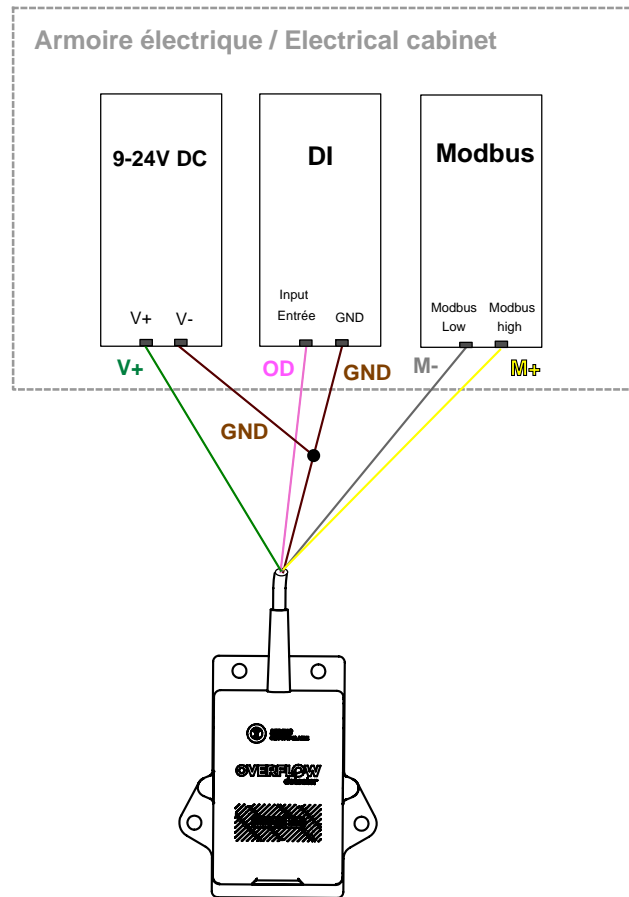

Digital output

- Connect the pink wire (Open-Drain) and the brown wire (V-) to the Open-drain digital input.

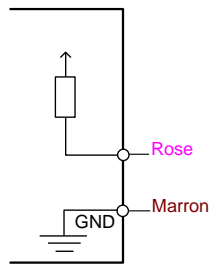

Digital input on PLC

External power supply



The overflow detector must be electrically powered using a voltage source between 9 and 24V DC. Power is supplied via the green wire (V+) and the brown wire (V-)

Connection is made to a secure voltage source equipped with a 100 mA limitation.

Modbus (RS485)



The detector must be powered by an external power supply as indicated in the paragraph [the section called "External power supply"](#).

- Connect the yellow wire (Modbus high) and the grey wire (Modbus low) to the PLC Modbus board.

Wiring - Bare wire version

Color	White ○	Brown ●	Green ●	YELLOW ●	Grey ●	Pink ●	Blue ●	Red ●
Signal Assignment	/	V-	V+ (+9 to 24 V DC)	Modbus High	Modbus Low	Open-Drain	/	/
Characteristic				Modbus RTU RS485 A	Modbus RTU RS485 B	Open drain output (30V 2A) Overflow status NO, NC or pulse depending on configuration		

M8-Male connectorised version

Wiring

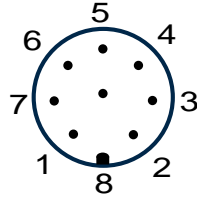

Male

Pin No.	1	2	3	4	5	6	7	8
Signal Assignment	none	V-	V+ (+9 to 24 V DC)	Modbus High	Modbus Low	Open-Drain	none	none
Characteristic				Modbus RTU RS485 A	Modbus RTU RS485 B	Open drain output (30V 2A) Overflow status NO, NC or pulse depending on configuration		

Chapter 8. Installation

8.1. Installation of a radar sensor



For distance measurements over 6 meters, firmware version 23.5 (minimum) must be installed (refer to paragraph [Firmware update](#)).

8.1.1. Positioning a radar sensor

A radar level sensor has a blind zone (**A**) requiring it to be installed at a minimum distance (**D**) from the measured surface. The recommended minimum distance is 15 cm.

A radar level sensor must be installed:

- perpendicular to the measured surface
- in the axis of the measured area (e.g. the axis of the culvert).

It is advisable to keep the total measuring distance (**D**) as short as possible. It is therefore advisable to position the sensor as close as possible to the maximum expected level, taking into account the blind zone (**A**).

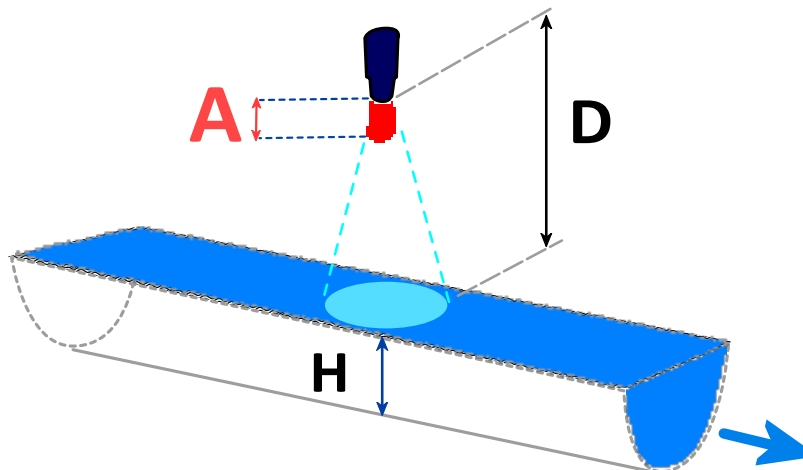

Measuring height over a culvert - (A) Blind zone - (D) Measuring distance - (H) Water height

Radar beam diameter

The further the sensor is from the measured surface, the greater the beam width and consequently, the greater the possibility that an echo from a parasitic obstacle (ladder rung, pipe, culvert, etc.) is captured. In this case, you need to use the "expert" calibration mode. The minimum and maximum emission ranges must therefore be respected, while the angle (α) of the radar emission cone must be taken into account to determine the area of the measurement surface, which should be as free of obstructions as possible.

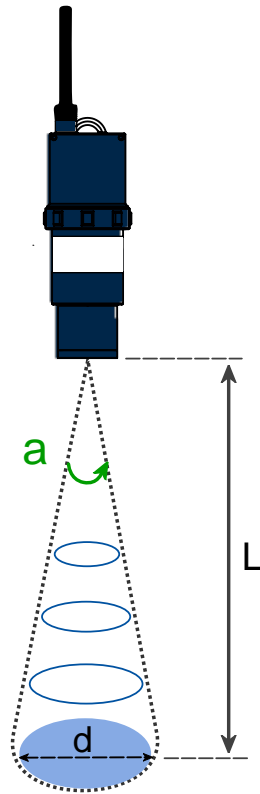

L (M)	d (cm)
0.25	4
0.5	6
1	14
1.5	20
2	28
2.5	34
3	42
3.5	48
4	56
4.5	62
5	70
5.5	76
6	84
6.5	90
7	98
7.5	104
8	112
8.5	118
9	126
9.5	132
10	140

Radar beam diameter (d) as a function of distance (L) with an emission cone angle (a) of 8°

Measuring over a main sewer

- Opt for a straight channel, with no other inlets or connections other than the upstream collector.
- Position the sensor centrally above the channel.

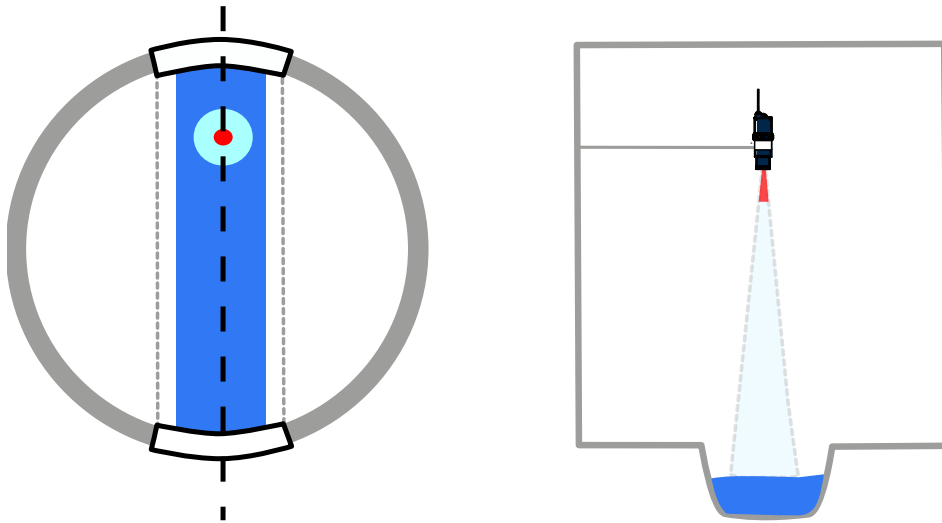

Measurement on a straight culvert

Positioning according to quality of water surface

An uneven water surface will reduce the accuracy of measurement.

- Place the sensor at a measurement point where all risks of disturbance are minimized.

8.1.2. Installation with mounting kit



Kit contents: 2 x mounting plates + 1 x bracket + 4 nuts and bolts



Assembled kit version 1



Assembled kit version 2



Example of installation with a mounting plate



Example of installation with two mounting plates

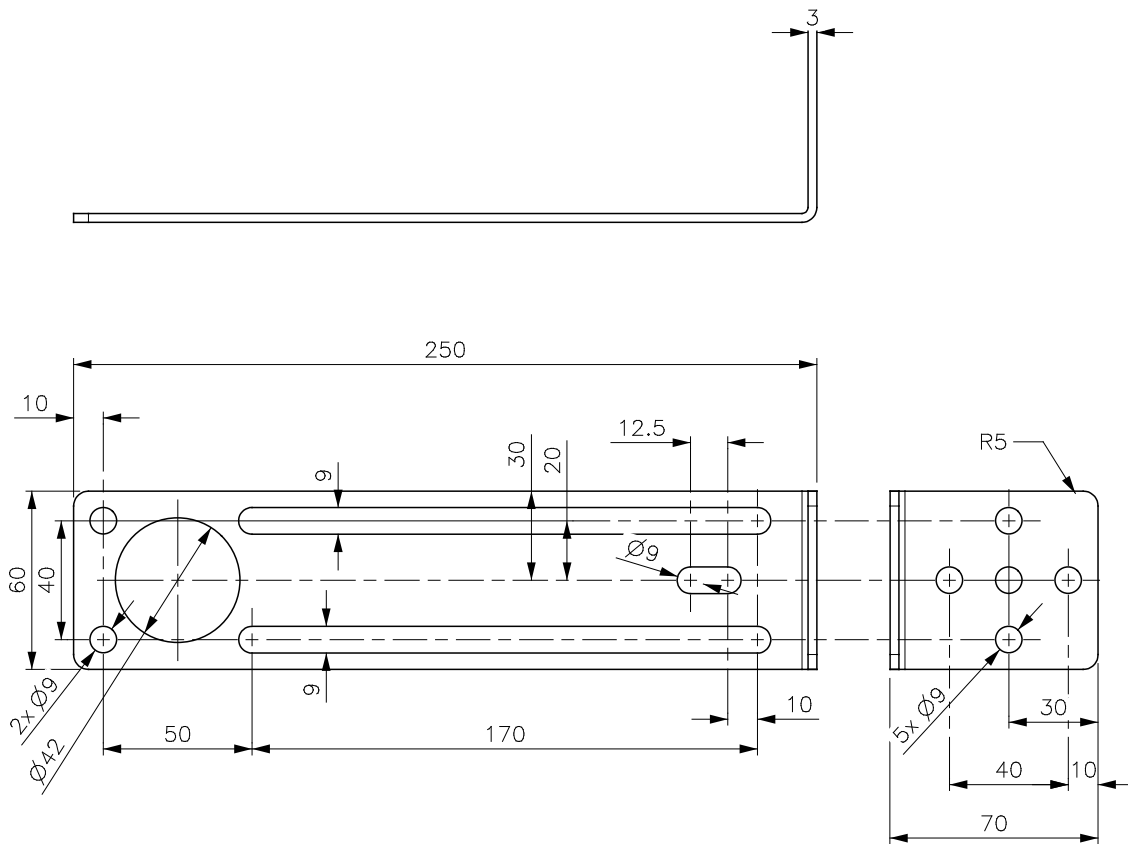

Mounting plate dimensions

Installing a clamp

To fit the Ijinus clamp:

- Position the clamp so that the Ijinus logo is aligned with the logger logo.
- To remove the clamp, insert a screwdriver into the notch (A) and pry the clamp loose.



Mounting the logger

- Use the specific clamp for Ijinus sensors and loggers (see [the section called "Installing a clamp."](#))
- Check the device is vertical using a spirit level or by measuring the angle on Avelour. The top of the cover should be as horizontal as possible.

8.1.3. Installing an angle rebate

In case the distance between the sensor and the water level to be measured is very small, the distance (**D**) is likely to be close to the blind area of the sensor. It is therefore possible to install a mounting kit with an angle rebate. The kit consists of a plate with a 135° angle.

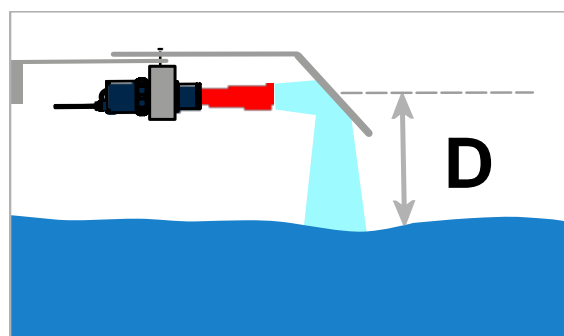



*Collar clamp + 4 nuts + 1 mounting plate
+ 1 mounting plate with angle rebate*



Assembled kit

- Use a spirit level to check that the installation is horizontal.



Installation with angle rebate mounting kit



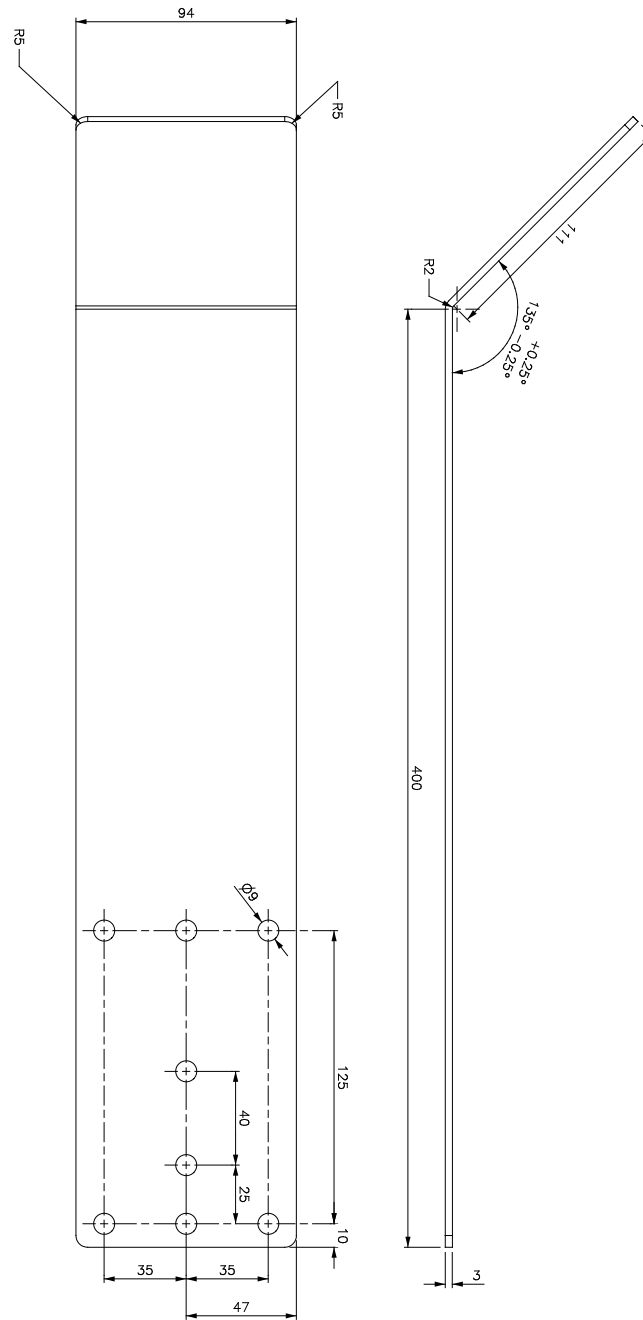

Angle rebate size

8.1.4. Installation of a remote antenna

The use of a remote antenna is useful in the case where the logger is installed in a manhole with a cover. In this case, data transmission may not be possible.

It is essential to use an Ijinus remote antenna. Three lengths are available as standard: 1, 3 or 5 meters. In exceptional cases, a length of 10 m can be offered.

Ijinus antennas have a thick cable and reinforced sealing, making them suitable for applications in sewerage networks and drinking water networks.

- Connect the antenna to the sensor by screwing it **firmly** by hand and all the way to ensure a good seal.
- Identify the best conditions for installing the antenna, in particular the drilling direction allowing the best communication quality.
- Drill so that the antenna is outside the area (A) of the sole.

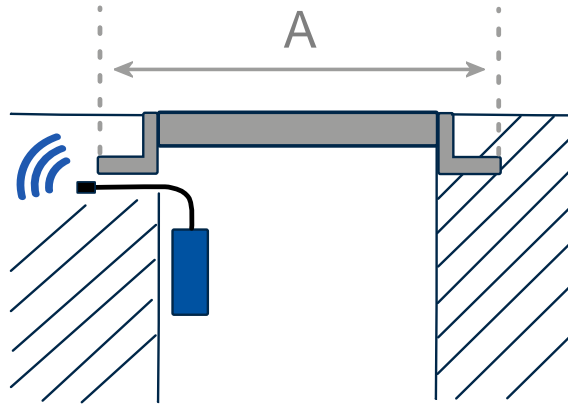

- Test the position and data transmission from Avelour software. This test must be carried out before and after installation (closed cover in the case of a manhole).



Drill hole in manhole



Inserting the antenna under the sole

8.2. Installing the OSRAI system

8.2.1. Principle

The Osrai Flow system is based on the obstruction principle using an "obstacle" to guarantee a hydraulic relation between the water flow and the water level upstream. The "semicircular" shape (seen from above) and installation one just one side of the culvert are designed to limit the risk of clogging and to fit into an existing manhole.

The size of the obstacle also means that reliable flow measurements can be obtained for upstream gradients of up to 4%.

An Ijinus sensor can be used to provide flow rates and therefore volumes transited. Several obstacle dimensions are available, depending on collector size, slope and minimum and maximum flow rates.

8.2.2. Site selection

Main sewer

The culvert must be straight (with no bends or side entries). Available in 200, 250 and 300 mm diameters.

H Osrai height

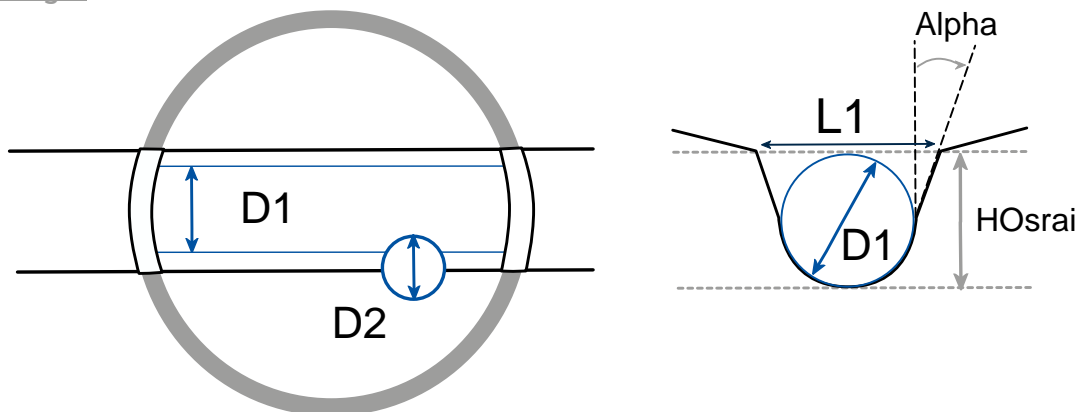

To guarantee the reliability of the relations between measured height and flow rate, these are valid between 0 mm and the upstream diameter of the collector (D1). Checking this height will verify the validity of the flow rates. This can be measured with a tape measure.

If the culvert is reduced to $D1/2$, $H_{Osrai} = D1/2$ mm

Angle Alpha

If the culvert is reduced to $D1/2$, or if it is raised by a vertical wall, then angle Alpha = 0°.

In other cases, there are two ways of calculating the angle Alpha:

- 1st case: Use a dedicated smartphone application.
- 2nd case: Use a spirit level fitted with a vial to measure the angle of rotation. Ideally, the angle should be measured after the Osrai Flow has been attached, by placing the spirit level against the Osrai Flow.

Manholes

The device is designed for 1000 mm diameter manholes.

Upstream requirement

Ideally, the straight approach length should be at least 10 times the pipe diameter (if phi 200 mm, then 2000 mm).

The upstream pipe can be used as this straight length, provided that the slope does not exceed 4% (depending on the obstacle selected, see below).

This length can be reduced in certain cases (consult us).

Downstream requirement

The requirement is to maintain a free flow outlet (i.e. the transition to supercritical state). Ideally, the downstream water level should be less than 80% of the upstream water level.

8.2.3. Choice of contraction

Pipe diameter phi 200 mm

Half-circular (*)	Maximum upstream gradient (%)	Q min (m ³ /h)	Q max (m ³ /h)
125 mm	1.2	0.3	88
160 mm	2.2	0.2	72

(*) relations established only for obstacles with slopes from 0 to 10° and validated for heights below the culvert.

Pipe diameter phi 250 mm

Half-circular (*)	Maximum upstream gradient (%)	Q min (m ³ /h)	Q max (m ³ /h)
125 mm	0.7	2	176
160 mm	1.6	0.5	151
200 mm	3.2	0.1	129

(*) relations established only for obstacles with slopes from 0 to 10° and validated for heights below the culvert.

Pipe diameter phi 300 mm

Half-circular (*)	Maximum upstream gradient (%)	Q min (m ³ /h)	Q max (m ³ /h)
160 mm	1.2	2.2	248
200 mm	2.2	0.5	219
250 mm	3.2	0.0	184

(*) relations established only for obstacles with slopes from 0 to 10° and validated for heights below the culvert.

8.2.4. Positioning and installation of the measuring system

The contraction is positioned no more than 30 cm downstream of the manhole, and the level sensor at least 30 cm upstream of the contraction, using the stainless steel brackets supplied.

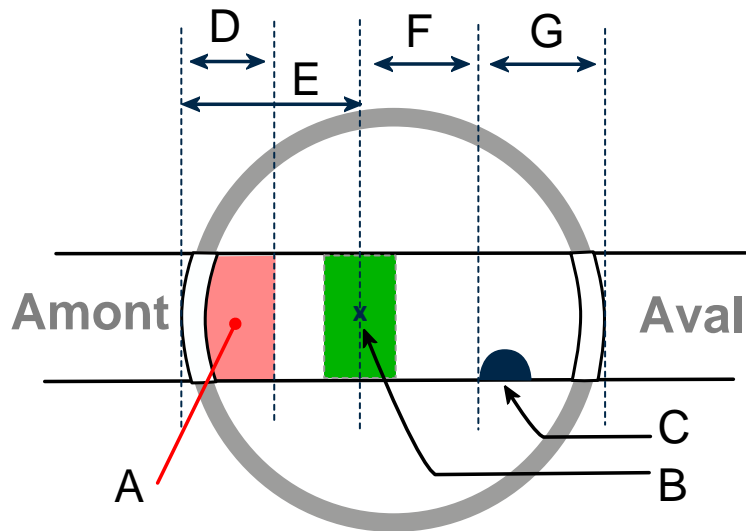
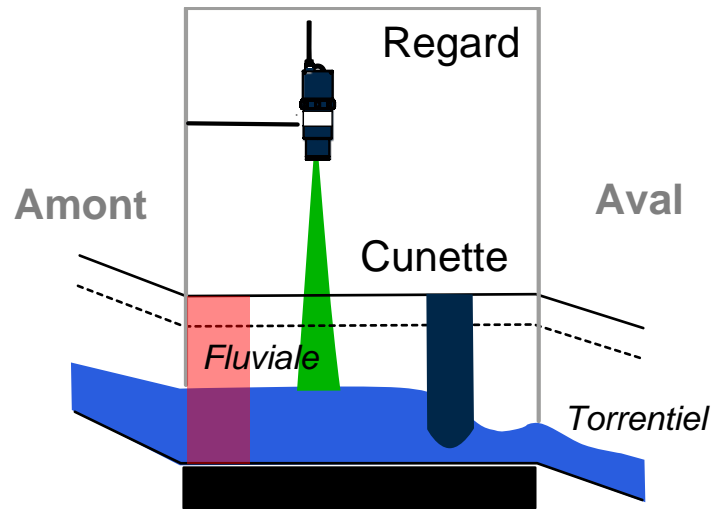

- | | | | |
|---|---|---|-------------------|
| A | Area to avoid for water level measurement | D | Distance = 0.25 m |
| B | Measurement point and suitable area for water level measurement | E | Distance = 0.4 m |
| C | Contraction position | F | Distance = 0.3 m |
| | | G | Distance = 0.3 m |



Example of system installation

8.2.5. Installing the contraction

- Locate the position where the contraction is to be installed ([Positioning and installation of the measuring system](#)) and drill the seat.
- Fit two dowels, maximum diameter 8 mm, but long enough to screw on the nuts.
- Adjust the vertical position using the adjusting screw (A) to ensure that the contraction is as close as possible to the culvert.

If the culvert has vertical edges, use a level to position the contraction vertically, fixing it to the edge of the culvert.

No water should pass between the Osrai and the wall of the culvert, and the water inside the Osrai should be calm.

- When the contraction is correctly positioned at the edge of the culvert, tighten the adjusting screw (A) to bring it into contact with the contraction.
- Screw on the nuts of the 2 dowels to secure the device mounting plate.
- Measure and record pipe diameter D1, contraction diameter D2, depth of H Osrai, angle Alpha.

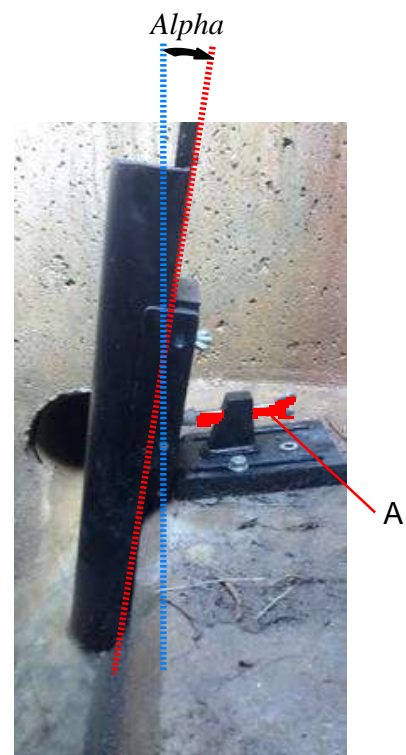

The Alpha, D1, D2 and H Osrai details are required to configure the measurement on the Avelour software [Radar Water height -> OSRAI Flow](#).

8.3. Installation of a tipping bucket rain gauge

8.3.1. Recommendations

Research group GRAIE provides installation recommendations in its Guide on Self-Monitoring of Sanitation Networks (2016):

The conditions for installing a rain gauge (or a network of rain gauges) are essential to guarantee the representativeness of the rainfall measured at variable space-time scales. Ideal conditions may not be met. Furthermore, in a densely urbanized environment, the variability of the altitude of surfaces subject to runoff can be a source of errors. The main recommendations are:

- the ground and cone must be horizontal;
- positioned 1 m from the ground;
- placed below the prevailing winds;
- distant more than 4 times the height of nearby trees or buildings;
- ease of access;
- density of 1 rain gauge per km²;
- discretization at a time interval of one minute.

8.3.2. Calibration



Set the logger to record bucket tips. This allows you to check later that all bucket tips have been recorded. (See [Recording of bucket toggles](#))

There are two types of rain gauge calibration:

- by zeroing the bucket,
- by measuring a volume of water.

Bucket zeroing

To check that a bucket is correctly zeroed:

- Determine the volume.

Example: if the receiving surface of the rain gauge cone is 400 cm² and that a tipped bucket corresponds to 0.2 mm of rain, then the volume of the bucket is 8 ml (400 cm² * 0.02 cm = 8 cm³).

- Using a graduated pipette or syringe, ensure that each bucket of the rain gauge tips a volume of 8 ml.
- If not, adjust the bucket volume using the adjustment screw located under each bucket.

Measuring a volume of water

The aim is to introduce a quantity of water into the rain gauge, to check that the number of bucket tips corresponds to the volume poured.



The greater the intensity of the rain, the less accurate the rain gauges are. The volume of water should therefore not be poured too quickly. Example: a maximum intensity of 100 mm/h with a 400 cm rain gauge² and 0.2 mm for each bucket tip corresponds to a maximum flow rate of 4 l/h or 67 ml/minute.

8.3.3. Checks

Equipment checks according to the Loire Bretagne water agency:

Guide for the implementation of self-monitoring of sanitation systems in communities and industries – November 2015 - Page 34:

"4. Rain measuring devices

The check is based on a simple volumetric verification. The operation consists of the following:

- Pour a liter of water into the rain gauge.
- Then compare the data recorded by the rain gauge. The results of the verification may lead to the calibration of the device (see existing bibliography including the work "Measurements in urban hydrology and sanitation").

Concretely, a drip system must therefore be used in order to pour 1 liter of water into the rain gauge in a minimum time of 15 minutes (still using the example of a maximum intensity of 100 mm/h with a 400 cm rain gauge² and 0.2 mm for each bucket tip). **This volume of 1 liter should correspond to 125 bucket tips.**

- If not, adjust the bucket volume using the adjustment screw located under each bucket.

8.4. Installation of an overflow detector

8.4.1. Positioning

The detection area is shown by a screen print on the surface of the housing, which allows the detector to be positioned according to the desired actuation threshold.



Avoid installing the detector in a location that would subject it to constant splashes. Such conditions are likely to disrupt detection.

Avoid installing the detector in an area where metal parts are facing the electrode.

8.4.2. Attachment using kit

- Use screws suited to the holes in the stainless steel backplate (maximum diameter 6 mm).

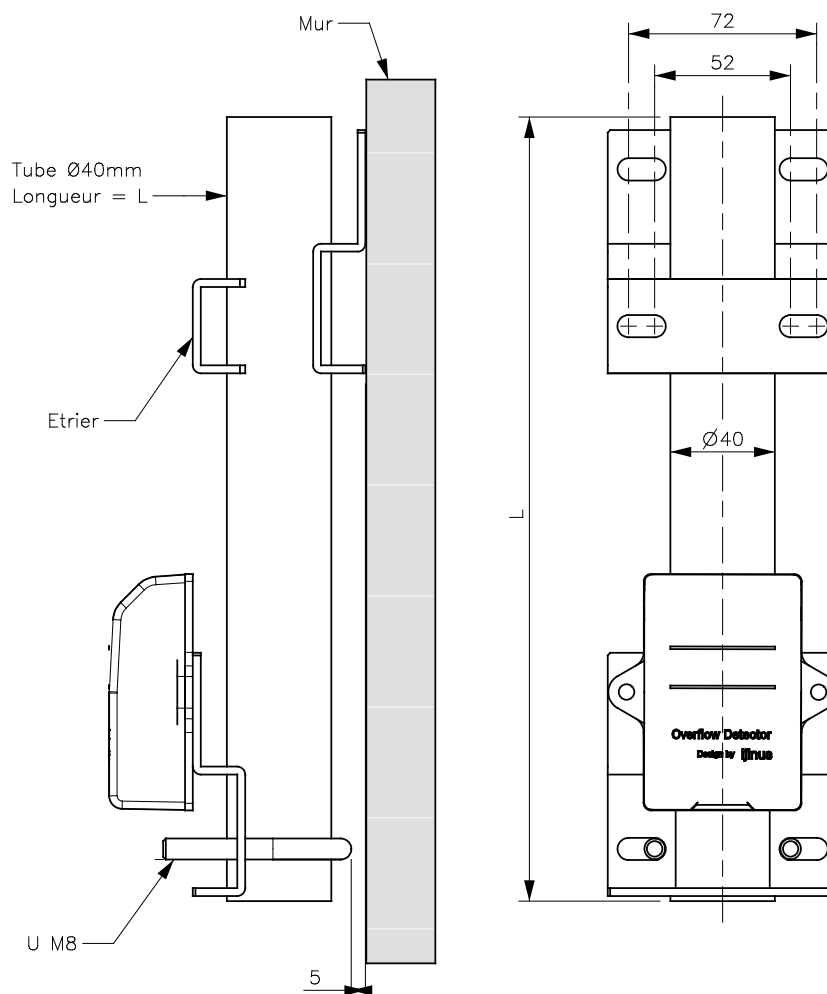

Mounting kit: H0T00054 (without tube)

8.4.3. Examples of installation



Installation in storm drain



Installation for monitoring grid fouling

Chapter 9. Configuration on Avelour

9.1. Equipment required

- Avelour software version 7.3 or later.
- A Wiji radio antenna in “long range” or “USB device” format.

9.2. Installing the Avelour software

The Avelour software can be downloaded from the IjInus website (www.ijinus.com) in the “Download” section.

- To install it in the background, open the Avelour software via the command line interface using space + /S after its name.

Example: `Setup_Avelour_7.1.2-Signed.exe /S`

9.3. Connecting to a logger

- Connect the Wiji radio access point and its antenna (or the Wiji USB device) to your computer’s USB port.

If the Wiji USB device is not detected:

- Remove the USB device from the port, reboot the PC and reinsert the device.
- If the device is still not detected, remove it and reinstall the drivers.

```
C:\Program Files (x86)\IjInus\Avelour_7.1.2\Driver
```

- Restart the PC and reinsert the USB device.
- Position your Wiji antenna at least one meter from the logger.
- Open the Avelour software.
- Open the logger selection window by clicking on “Connect to a wireless device”.



- Select the logger identified by its serial number (refer to its nameplate) and click “OK”.



www.ijinus.com

Location of serial number

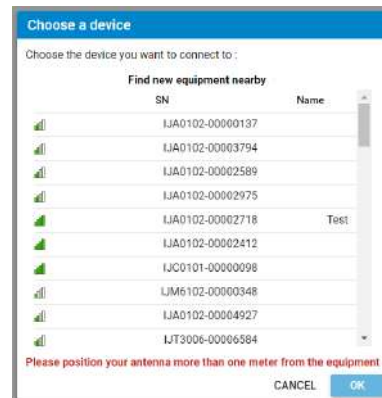

-> The logger configuration window opens.

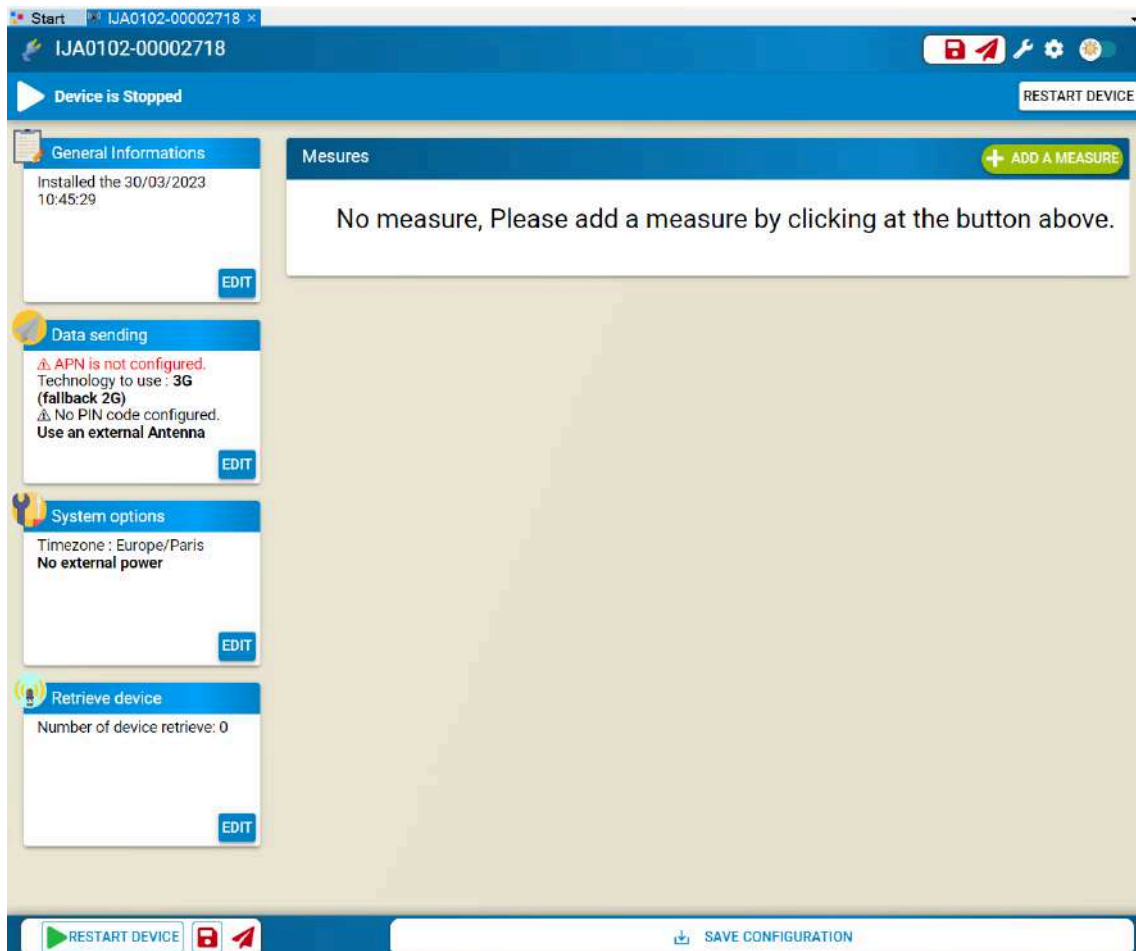

Configuration window for logger S/N: IJA0102-00002718

-> A configuration file is automatically created.

-> A folder is created in the following directory: C:\ProgramData\Ijinus\Avelour_Main_7.1.2\SavedSensors\IJA0102-00002718

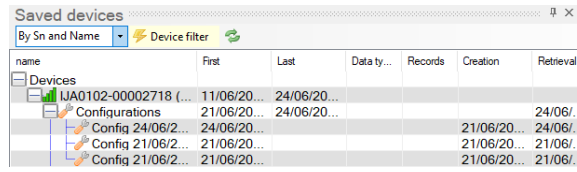

The screenshot shows a window titled "Saved devices" with a search bar and a "Device filter" button. Below is a table with columns: name, First, Last, Data ty..., Records, Creation, and Retrieval. The table content is as follows:

name	First	Last	Data ty...	Records	Creation	Retrieval
Devices						
UA0102-00002718 (...)	11/06/20...	24/06/20...				
Configurations	21/06/20...	24/06/20...				24/06/...
Config 24/06/2...	24/06/20...				21/06/20...	24/06/...
Config 21/06/2...	21/06/20...				21/06/20...	21/06/...
Config 21/06/2...	21/06/20...				21/06/20...	21/06/...

Configuration file in the saved data browser.

9.4. Protect the logger using a password

9.4.1. Activation



To activate the protection, the latest firmware version and at least version 7.3 of Avelour must be installed.

By default, password protection is not active.

To activate it:

- In the system options, click on **Activate**  and enter the following password using the required format (see [Password Format](#) paragraph).

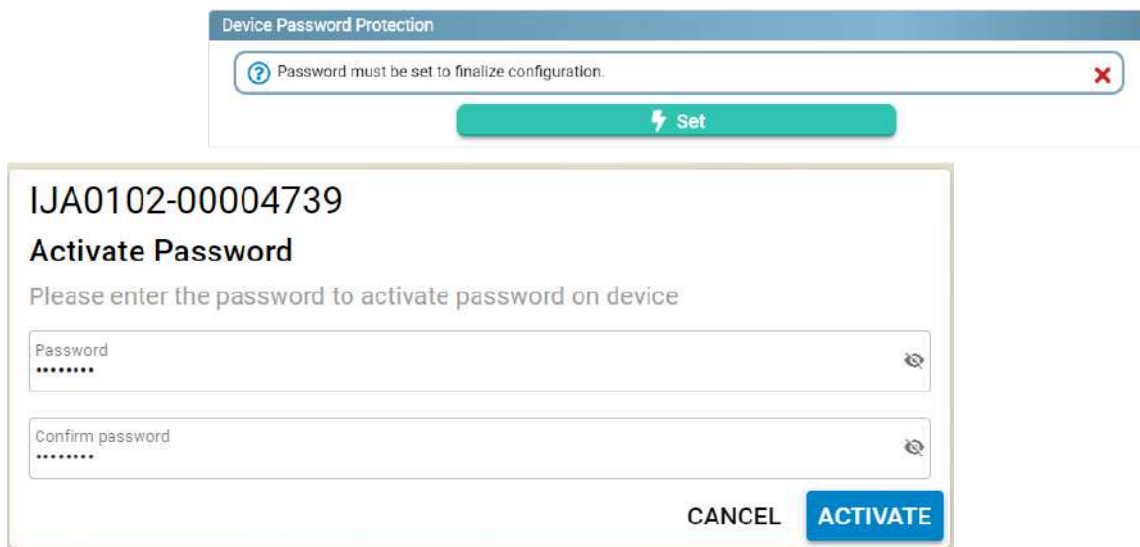

Password input and confirmation window

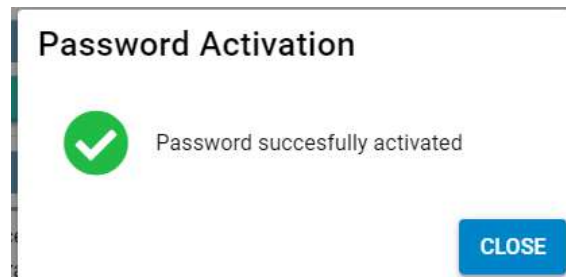

-> A temporary password is saved in Avelour for the current session and as long as Avelour is not closed, the password is not requested again.

-> After 3 failed attempts, you must redo the connection process from the start.

-> The Password is required to review the configurations that were generated while the password was activated (presence of a padlock).

IJA0102-00004708	12/05/20...
Configurations	12/05/20...
Config. 13/05/2025 16:24:...	13/05/20...
Config. 13/05/2025 16:21:...	13/05/20...
Config. 13/05/2025 14:30:...	13/05/20...
Config. 13/05/2025 14:30:...	13/05/20...
Config. 13/05/2025 08:50:...	13/05/20...
Config. 13/05/2025 08:47:...	13/05/20...
Config. 13/05/2025 08:47:...	13/05/20...
Config. 12/05/2025 17:12:...	12/05/20...

Password-locked configuration files

9.4.2. Password Format

The rules for the password format are as follows:

- Maximum length of 64 characters.
- Characters NOT allowed: **Space, accent and cedilla** .
- Minimum length: 1 character.
- No restrictions on the combination of characters.

9.4.3. Forgotten password

In case of a forgotten password:

- Manually reset the logger. (see [Manual reset](#)).



A manual reset deletes all settings and data files stored on the logger.

9.5. General configuration information

Editing the general information parameters allows you to input information concerning the identification of the logger, the measurement point, the date and any comments.

- Click on "Edit" and enter the required information if necessary.

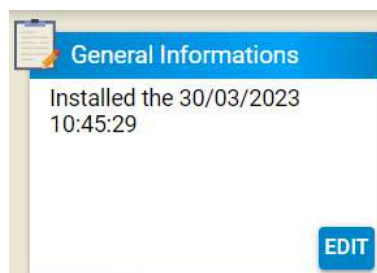

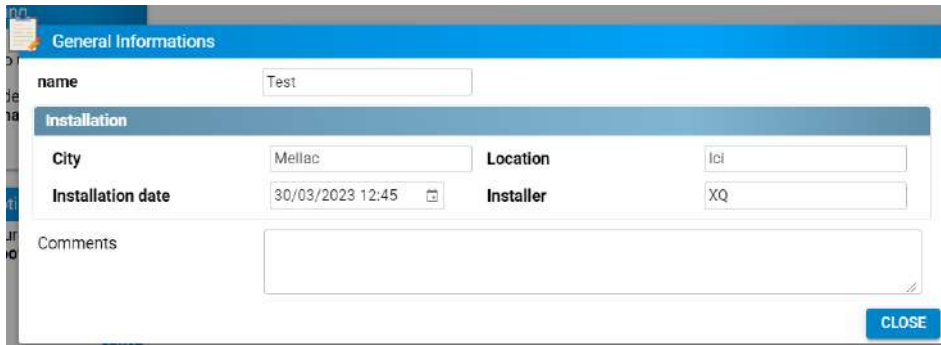

General Informations			
name	Test		
Installation			
City	Mellac	Location	Ici
Installation date	30/03/2023 12:45	Installer	XQ
Comments			
CLOSE			

General information editing window

9.6. Configuring a measurement recording

9.6.1. Radar Water height

Principle

Radar is a system that uses electromagnetic (radio) waves to detect the presence and position of an object.

To measure the water level, the sensor is placed above the flow and emits short pulses towards the water surface. The waves are reflected by the water surface and returned to the sensor, which measures the time they take to travel. The travel time is directly proportional to the distance between the sensor and the water surface. Now that it knows the distance between the sensor and the bottom of the water, the sensor calculates the water height.

Radar calibration



For distance measurements of more than 6 metres, version 7.2 of Avelour is required and the firmware installed must at least version 23.5 (refer to paragraph [Firmware update](#)).



Prerequisites: In Avelour, the Wiji connection to the logger must be established, see [Connecting to a logger](#).



Before calibration, make sure the radar sensor is correctly positioned (see paragraph [Positioning a radar sensor](#)).

- Click on  to start radar sensor calibration.

-> A distance measurement is automatically started and the calibration window opens.

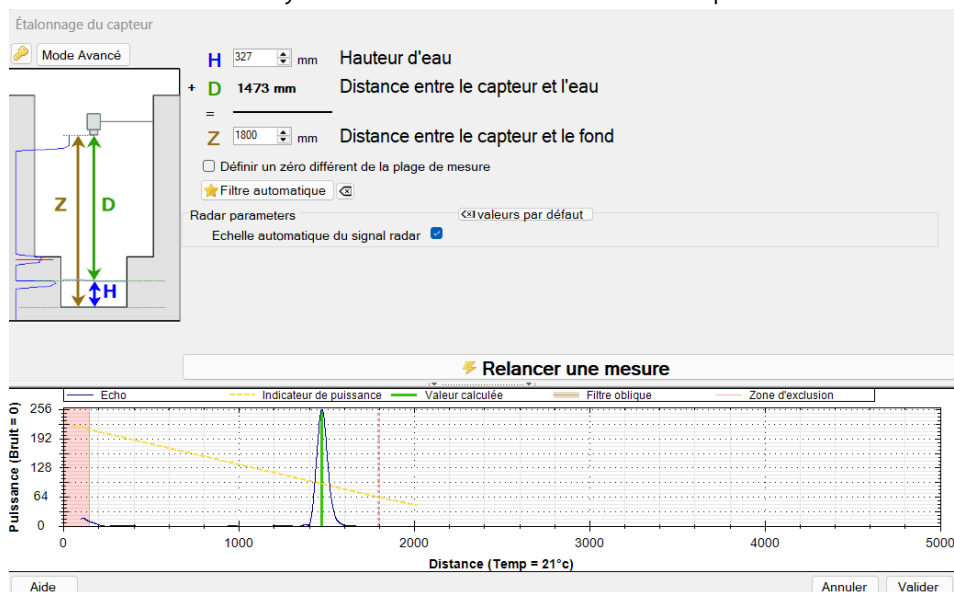

- Enter the distance between the sensor and the bottom and click on "Launch a new measure" to save the configuration changes on the sensor and view the result.

Echo graph

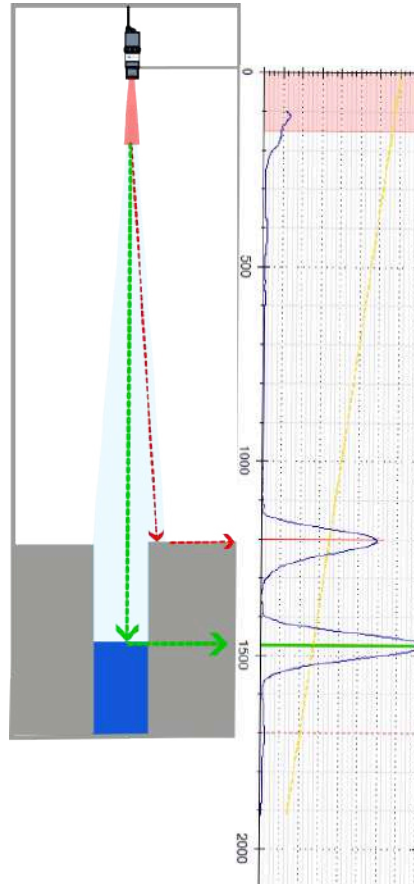

The graph displayed shows the echo of the radar wave returned:

- The peaks indicate where the sensor "detects" an obstacle.
- Red lines indicate whether obstacles are detected that could interfere with the measurement.
- The dotted red line indicates the Z configured.
- The shape at the start of the echo corresponds to the "blind" zone for the sensor, in which no measurements can be taken.
- The red zone corresponds to the sensor's blind zone filter, the brown zone to the oblique filter. These filters are defined in advanced mode.
- The green line indicates the obstacle which is considered the correct measurement by the sensor.
- The yellow line indicates the recommended level of measurement: The peak representing the correct measurement should be near this line.
- The advanced mode button provides additional echo filtering functions. The key button gives access to the expert settings.



You can zoom in on the graph using the mouse wheel.

- To restore the initial display, double-click on the graph.

Define a zero outside the measurement range

It is possible to define a "zero" level other than the culvert, particularly useful for storm overflows, for example, where it is possible to set the zero at the level of the overflow weir.

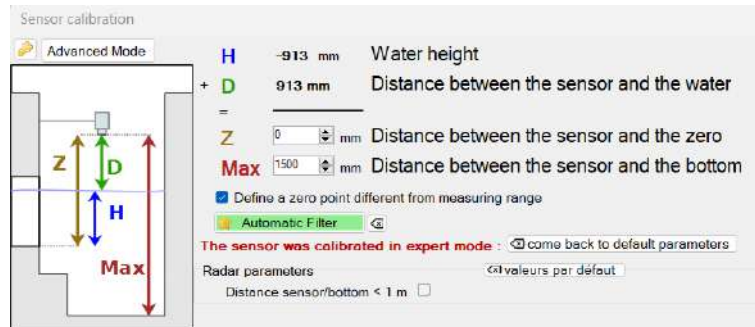

Advanced mode

Click on "Advanced mode" to display measurement and computation parameters.

Measurement parameters

Gain: Adjust the amplification when receiving the radar wave.

Number of integrations: Number of successive echoes emitted.

Type of integration: Echo processing, the "minimum", an "average" or the "maximum".

Computation parameters

Exclusion zone: Value in mm of the sensor blind zone.

Filter y-axis: Adjust the power of the filter.

Filter coefficient: Adjust the slope of the filter.

Radar settings

Automatic signal scale: Automatic adjustment of the radar signal display to full scale

Offset: Adjustment of the measured distance D to reach the actual distance.

Critical Obstacle echo processing: Apply an oblique filter

In case of a message: **ATTENTION! : Potential obstacle(s) detected**, insofar as possible you must modify the positioning of the sensor to correct the problem (see [Positioning a radar sensor](#)).

In the example below, a critical obstacle is detected (in red). It corresponds to a fixed obstacle near the sensor.

- Before applying a filter, check whether the positioning can be modified to obtain a cleaner measurement.

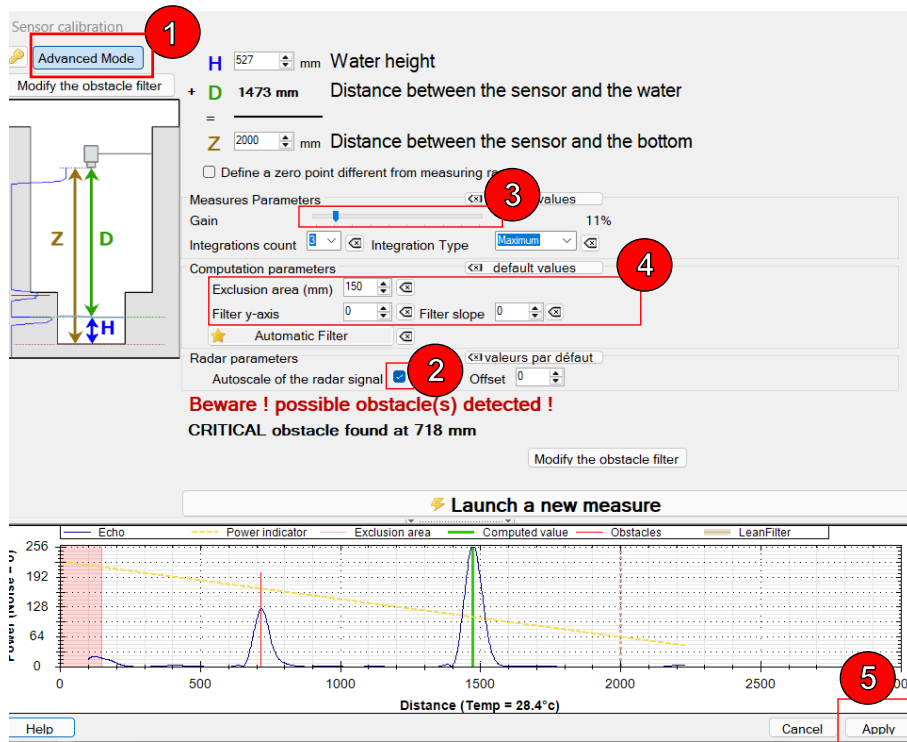

This echo can be processed using an oblique filter that can be configured as follows:

- Click on the “Advanced mode” button to display the processing parameters (1).
- Uncheck (2) the radar parameter: **Autoscale of the radar signal**.

In this case, automatic display processing must remain inactive to prevent it from further amplifying the amplitude of the echo of the obstacle, which must remain constant regardless of the amplitude of the peak returned by the echo of the water (distance D in green).

- Adjust the **gain** (3) so that the amplitude of the green peak is slightly above the power indicator (yellow line) and redo the measurement to refine the settings until you get a result as shown below.

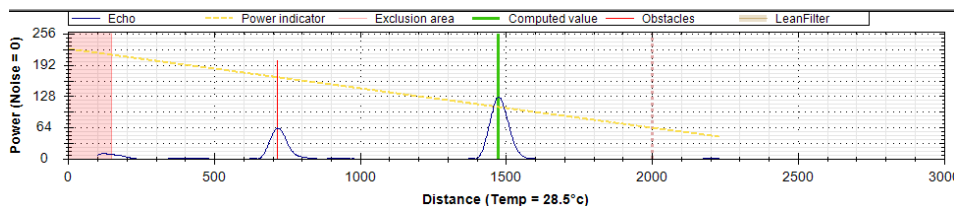

- Adjust the filter settings (4) to obtain a result similar to the example below.
 - Define filter power: **Filter y-axis**, equal to 220 in the case above.
 - Define its slope: **Filter slopet**, equal to 34 in the case above.

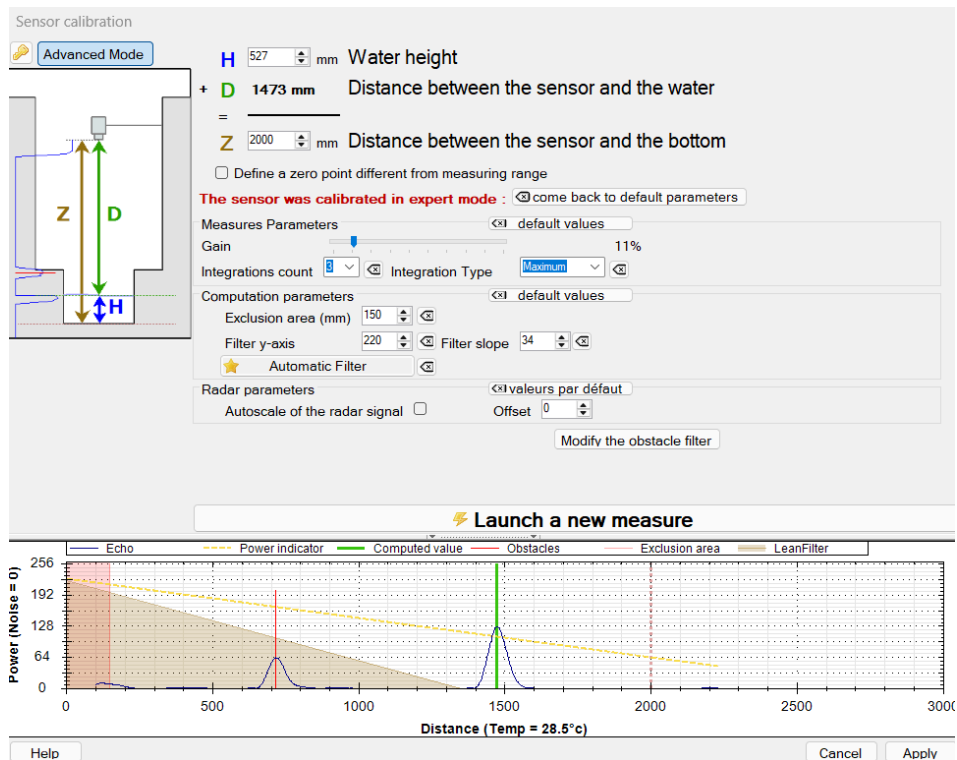

- Click on “Validate” (5) to apply the processing.

Critical obstacle echo processing: Apply an obstacle filter

In case of a message: **ATTENTION! : Potential obstacle(s) detected**, insofar as possible you must modify the positioning of the sensor to correct the problem (see [Positioning a radar sensor](#)).

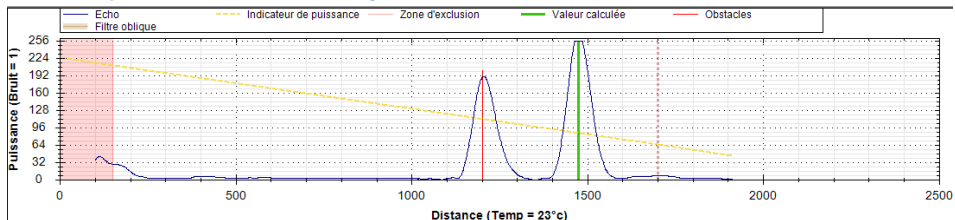

- Before applying a filter, check whether the positioning can be modified to obtain a cleaner measurement.

If this is not possible, and if the oblique filter is not applicable in the case where the obstacle is too close to the water, then you must create an “obstacle filter” which consists in masking the obstacles that interfere with the measurement such as fixed obstacles such as culverts or any other bars in the cone of the radar beam.

- Click on the “Advanced mode” button to display the processing parameters (1).
- Uncheck (2) the radar parameter: **Automatic signal scale**.

In this case, automatic display processing must remain inactive to prevent it from further amplifying the amplitude of the echo of the obstacle, which must remain constant regardless of the amplitude of the peak returned by the echo of the water (distance D in green).

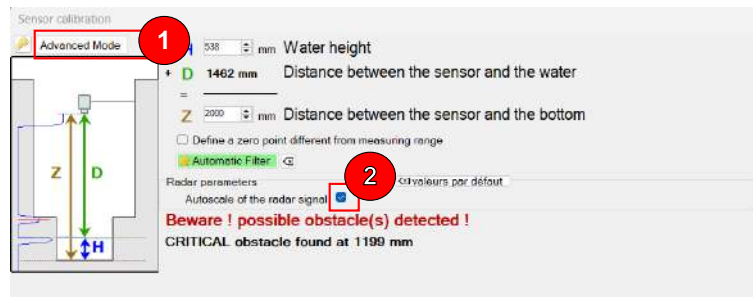

- Adjust the **gain** (3) so that the amplitude of the green echo is slightly above the power indicator (yellow line) and redo the measurement to refine the settings until you get a result as shown below.

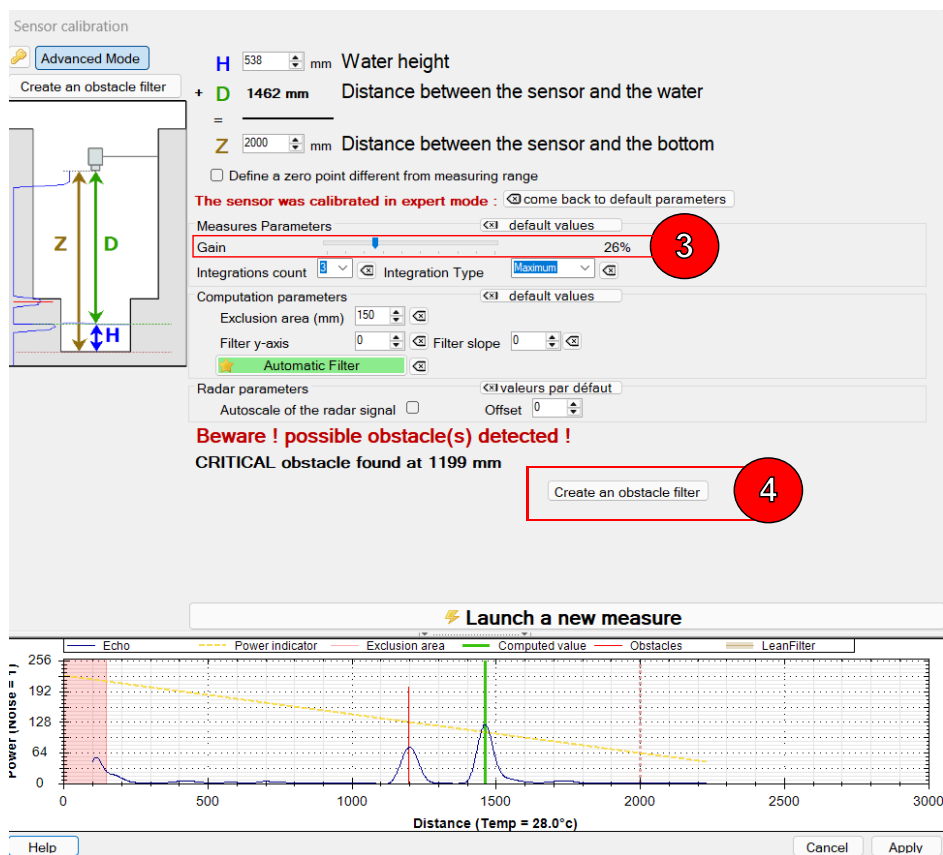

- Click on **Create an obstacle filter** (4).
- Select the echo of the obstacle to be filtered for the **obstacle** check box (5) and the echo of the distance measure D for the **measurement** check box (6).
- Click on “Create filter” (7).

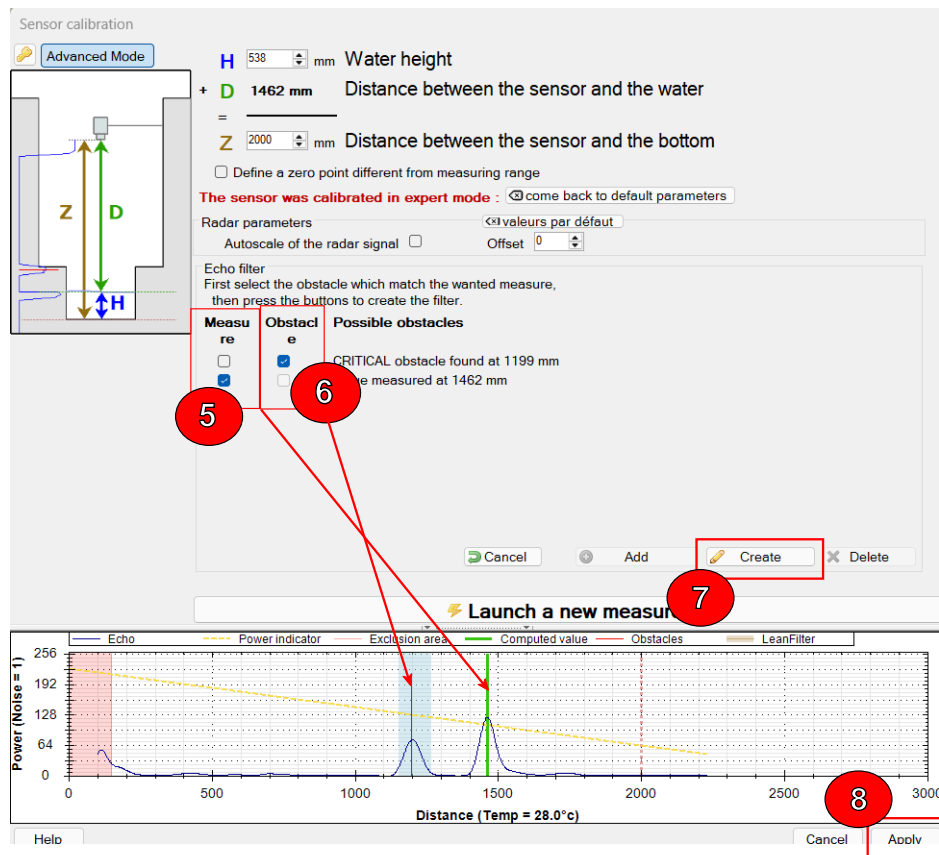

- Click on Validate (8) to apply the processing.

-> The obstacle echo is masked by a filter and appears in red on the graph.

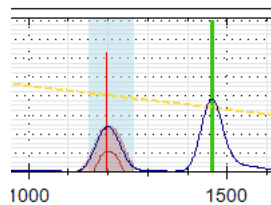

Filtered obstacle

Complex cases: expert mode

Expert mode is reserved for delicate cases requiring a certain level of expertise in data processing using ultrasonic or radar measurement. Numerous parameters are available. This activity is not detailed in this documentation. **Switching to expert mode is password-protected. Contact your correspondent or Ijinus if you need to use this expert mode, and we'll provide you with the password and explanations.**

Water level measurement configuration





Prerequisites: In Avelour, the Wiji connection to the logger must be established, see [Connecting to a logger](#).

- Click on  to add a measurement configuration and select "Radar water height".

Measure period

- Select a period between each measurement from the list. In the example above, a measurement will be taken every 15 minutes.

Record distance between sensor and water (Advanced parameter)

Click on  to display and activate  if necessary, record the distance **D** between the sensor and the water for each measurement.

Debugging echoes (Advanced settings)

Debugging echoes are recorded when there are differences between two successive level measurements (on rise and/or descent: here 75 mm for both), the acoustic signature of the measurements, or ultrasound echoes (already detailed above). A posteriori examination will then enable us to diagnose the quality of level measurements and correct calibration to obtain more easily usable measurements. For first-time installations, or in the case of delicate points, we strongly advise you to activate this function.

Height value for loss of echo (Advanced settings)

In the field of ultrasound, echo loss means the absence of a peak (or a peak so weak that it is not detected as an obstacle) on the echoes, which is materialized by a maximum height, i.e. equal to the Z entered during calibration. When the sensor encounters this situation, this function replaces the erroneous "a priori" value with a value of the user's choice: last valid value, value to be defined, etc.

Although this function can be useful, it must be used judiciously and should not be used to compensate for unsuitable calibration.



Modifying the frequency of measurements on a measurement threshold

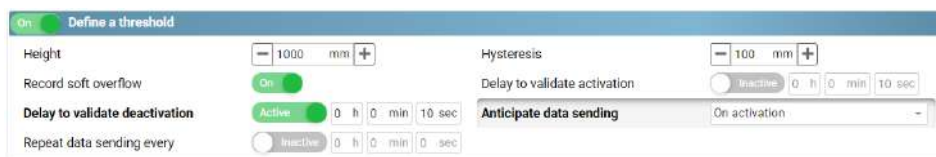

- Activate  **Change measure period on height threshold** to display the configuration parameters.

Changed period: New measurement frequency applied when the threshold is reached.

Direction: Defines whether the measured level threshold passes above a high level or below a low level.

Height: Threshold to be reached to activate modification. **Hysteresis:** Value to be subtracted (high threshold) or added (low threshold) to the level at which the measurement frequency returns to its initial value.

Minimum time before deceleration: Hold time for the new measurement frequency before returning to its initial value.

Example: Measure period changes from 5 minutes to 10 seconds when the water level exceeds 1000 mm. When the water level falls below 800 mm, for 1 minute, the measure period remains at 10 seconds, then returns to 5 minutes.

Defining an overflow threshold

Recording of an overflow file from a high or low level threshold can be activated .

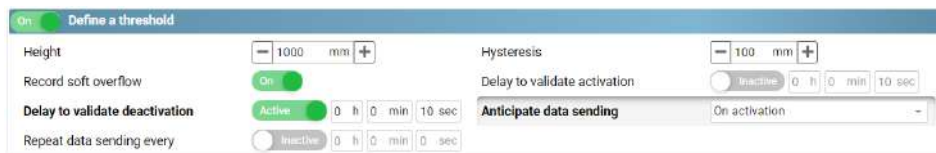

Height : Level threshold at which overflow status changes to 1. **Hysteresis:** Value to be subtracted from the threshold at which the overflow state returns to 0.

Delay to validate activation: Time after which the overflow status changes to 1. **Delay to validate deactivation:** Value to be subtracted from the threshold at which the overflow state returns to 0.

Anticipate data sending: Data transmission can be forced on activation of overflow status, deactivation of overflow status or both. **Repeat data sending every:** If data transmission on activation is selected, data can be sent at a set frequency.



If anticipate data sending is activated, an alert SMS is sent to an operator if the option is enabled (see [Sending an alert SMS](#)).

Example: If the height level exceeds 1000 mm for 1 minute, the overflow status changes to 1, and data are sent once, then a second time 10 minutes later. If the measured height falls below the 900 mm threshold for 1 minute, the overflow status returns to 0.

Record soft overflows

- Activate **software overflow recording** to record overflow states.

Recording channel (Advanced parameter)

- Click on  to change the channel for recording overflow states.

Fifo Memory (Advanced Setting)

By default, when the logger memory is full, data are deleted in chronological order of recording, from oldest to newest.

- Click  to display advanced settings.
- If Fifo memory is disabled, change the maximum number of timestamps for the main memory (used for sending data via Internet) and the auxiliary memory (used for sending data via SMS) if necessary.

Maximum records SMS Maximum records

Define a second threshold

This level threshold is used to force data transmission at a second defined height.

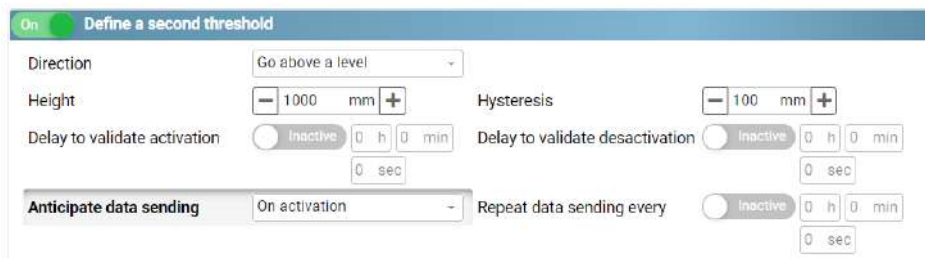

Direction: Defines whether the measured level threshold passes above a high level or below a low level.

Height: Height threshold.

Hysteresis: Value to be subtracted from the threshold at which the overflow state returns to 0.

Delay to validate activation: Time after which the threshold is reached.

Delay to validate deactivation: Time after which the threshold is no longer reached.

Anticipate data sending: Data can be sent on activation, deactivation or both.

Repeat data sending every: If data transmission on activation is selected, this enables you to modify the data transmission period.



If anticipate data sending is enabled, then when the threshold is reached, an alert SMS is sent to an operator if the option is enabled (see [Sending an alert SMS](#)).

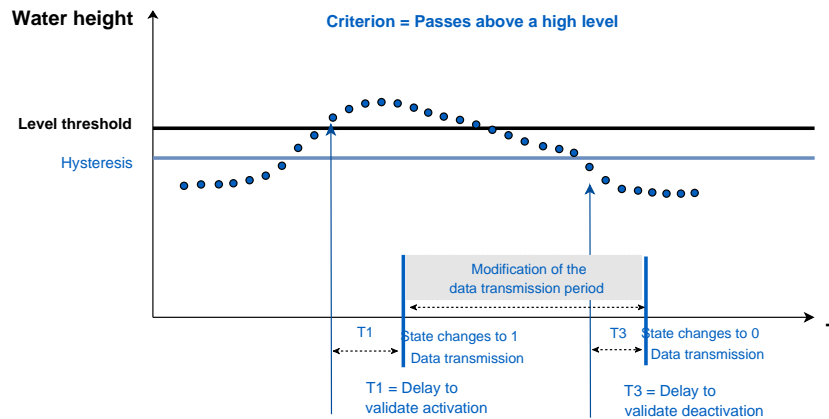

Mapping table between DataID, channel & data

DataId	Channel	Data displayed	Units	Data Description	Data files
3	7	Debug (signed integer value)	mAh	Internal battery current consumption	*_diag.bin
6	0	Voltage	V	Instantaneous internal battery voltage (Res. 0.05 V)	*_diag.bin
6	1	Voltage	V	Minimum internal battery voltage reached (Res. 0.05 V)	*_diag.bin
12	0	Measure temperature	°C	Sensor temperature measurement (Res. 0.1°C)	*_radar.bin
15	0	Material height	mm	Water Height	*_radar.bin
17	0	GSM signal Power	dBm	GSM signal power	*_diag.bin
19	0	Date	-	POSIX time	Asynchronous data
20	0-7	Overflow	-	Overflow status	*_ovsoft.bin
36	0	Distance	mm	Sensor-Water distance	*_radar.bin
44	2	Angle	°	Roll angle (Res. 0.1°)	*_angle.bin
44	3	Angle	°	Longitudinal axis angle (Res. 0.1°)	*_angle.bin

9.6.2. Radar Water height -> Flow

Principle

Radar is a system that uses electromagnetic (radio) waves to detect the presence and position of an object.

To measure the water level, the sensor is placed above the flow and emits short pulses towards the water surface. The waves are reflected by the water surface and returned to the sensor, which measures the time they take to travel. The travel time is directly proportional to the distance between the sensor and the water surface. Now that it knows the distance between the sensor and the bottom of the water, the sensor calculates the water height.

Radar calibration



For distance measurements of more than 6 metres, version 7.2 of Avelour is required and the firmware installed must at least version 23.5 (refer to paragraph [Firmware update](#)).



Prerequisites: In Avelour, the Wiji connection to the logger must be established, see [Connecting to a logger](#).



Before calibration, make sure the radar sensor is correctly positioned (see paragraph [Positioning a radar sensor](#)).

- Click on  to start radar sensor calibration.

-> A distance measurement is automatically started and the calibration window opens.

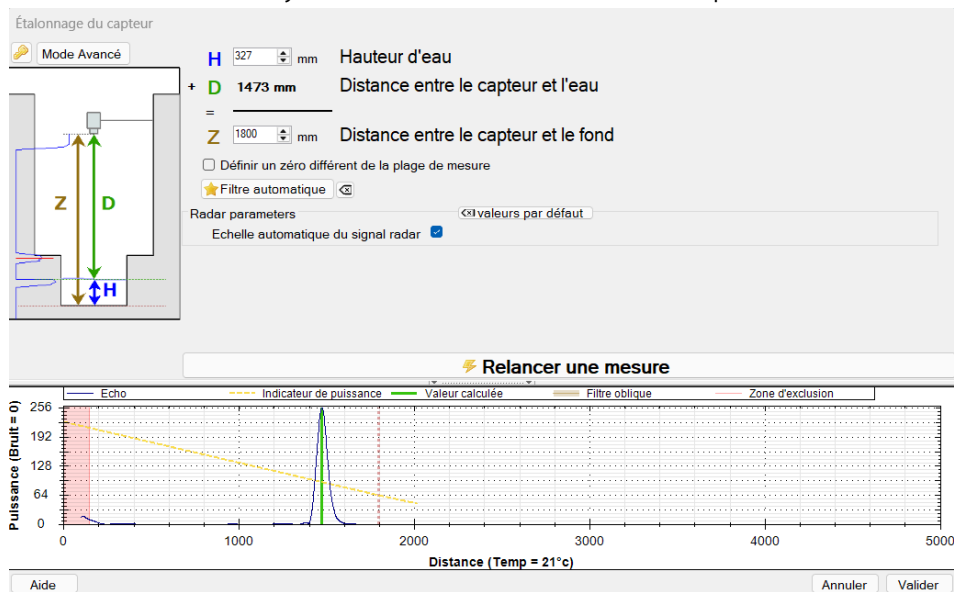

- Enter the distance between the sensor and the bottom and click on "Launch a new measure" to save the configuration changes on the sensor and view the result.

Echo graph

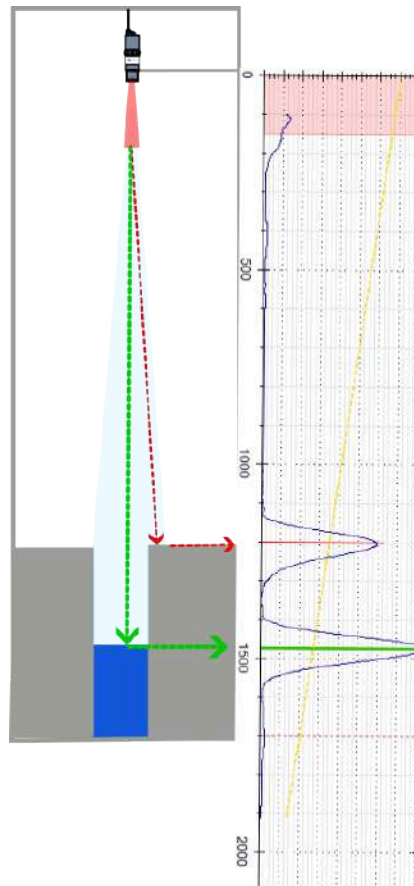

The graph displayed shows the echo of the radar wave returned:

- The peaks indicate where the sensor "detects" an obstacle.
- Red lines indicate whether obstacles are detected that could interfere with the measurement.
- The dotted red line indicates the Z configured.
- The shape at the start of the echo corresponds to the "blind" zone for the sensor, in which no measurements can be taken.
- The red zone corresponds to the sensor's blind zone filter, the brown zone to the oblique filter. These filters are defined in advanced mode.
- The green line indicates the obstacle which is considered the correct measurement by the sensor.
- The yellow line indicates the recommended level of measurement: The peak representing the correct measurement should be near this line.
- The advanced mode button provides additional echo filtering functions. The key button gives access to the expert settings.



You can zoom in on the graph using the mouse wheel.

- To restore the initial display, double-click on the graph.

Define a zero outside the measurement range

It is possible to define a "zero" level other than the culvert, particularly useful for storm overflows, for example, where it is possible to set the zero at the level of the overflow weir.

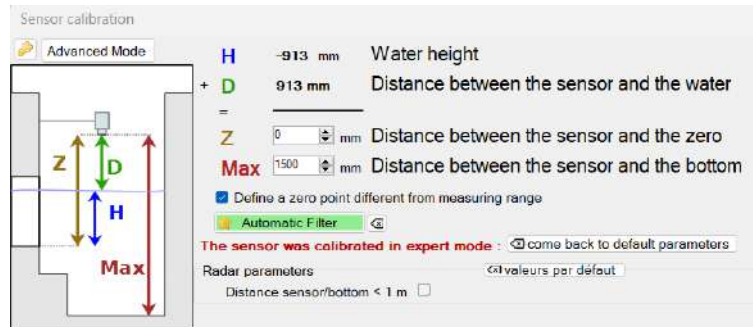

Advanced mode

Click on "Advanced mode" to display measurement and computation parameters.

Measurement parameters

Gain: Adjust the amplification when receiving the radar wave.

Number of integrations: Number of successive echoes emitted.

Type of integration: Echo processing, the "minimum", an "average" or the "maximum".

Computation parameters

Exclusion zone: Value in mm of the sensor blind zone.

Filter y-axis: Adjust the power of the filter.

Filter coefficient: Adjust the slope of the filter.

Radar settings

Automatic signal scale: Automatic adjustment of the radar signal display to full scale

Offset: Adjustment of the measured distance D to reach the actual distance.

Critical Obstacle echo processing: Apply an oblique filter

In case of a message: **ATTENTION! : Potential obstacle(s) detected**, insofar as possible you must modify the positioning of the sensor to correct the problem (see [Positioning a radar sensor](#)).

In the example below, a critical obstacle is detected (in red). It corresponds to a fixed obstacle near the sensor.

- Before applying a filter, check whether the positioning can be modified to obtain a cleaner measurement.

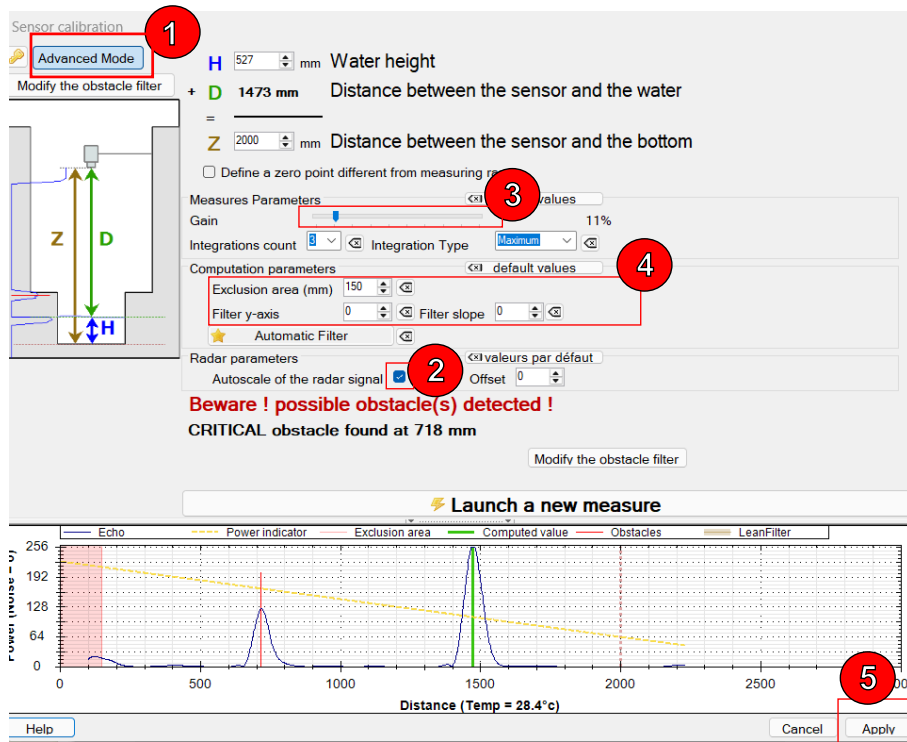

This echo can be processed using an oblique filter that can be configured as follows:

- Click on the “Advanced mode” button to display the processing parameters (1).
- Uncheck (2) the radar parameter: **Autoscale of the radar signal**.

In this case, automatic display processing must remain inactive to prevent it from further amplifying the amplitude of the echo of the obstacle, which must remain constant regardless of the amplitude of the peak returned by the echo of the water (distance D in green).

- Adjust the **gain** (3) so that the amplitude of the green peak is slightly above the power indicator (yellow line) and redo the measurement to refine the settings until you get a result as shown below.

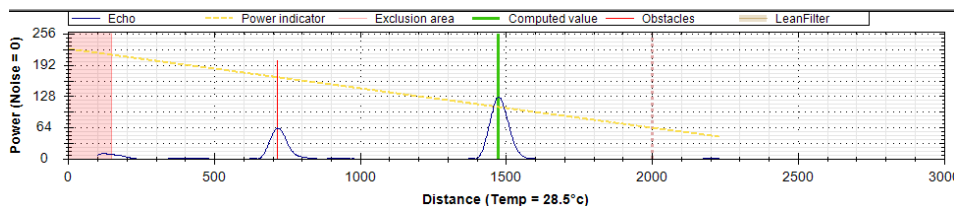

- Adjust the filter settings (4) to obtain a result similar to the example below.
 - Define filter power: **Filter y-axis**, equal to 220 in the case above.
 - Define its slope: **Filter slopet**, equal to 34 in the case above.

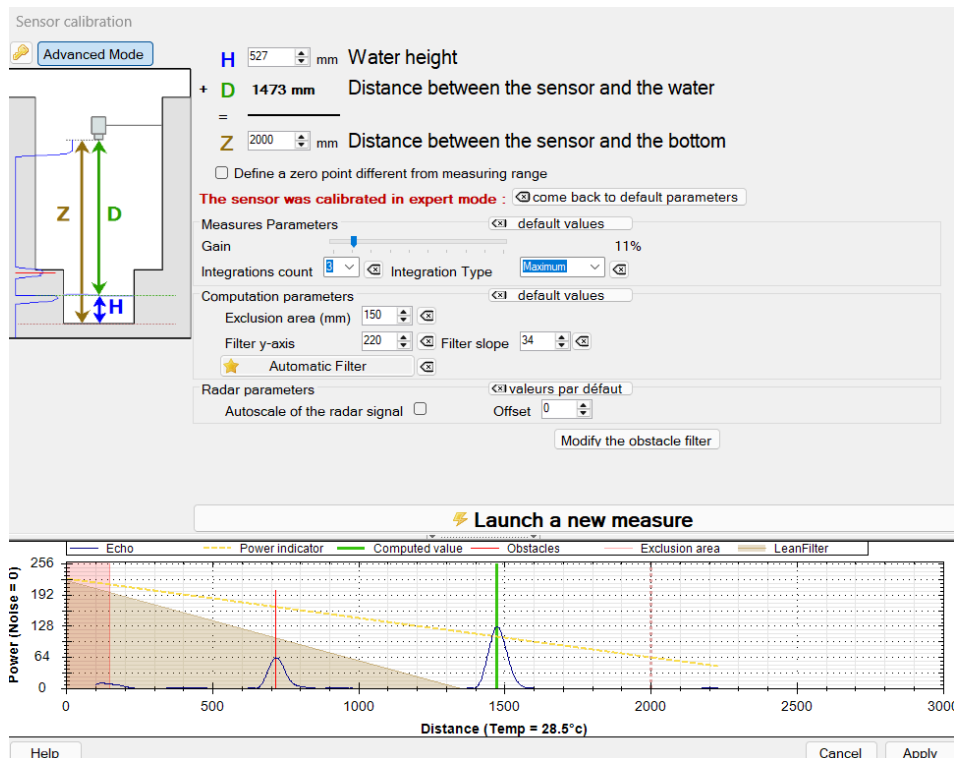

- Click on “Validate” (5) to apply the processing.

Critical obstacle echo processing: Apply an obstacle filter

In case of a message: **ATTENTION! : Potential obstacle(s) detected**, insofar as possible you must modify the positioning of the sensor to correct the problem (see [Positioning a radar sensor](#)).

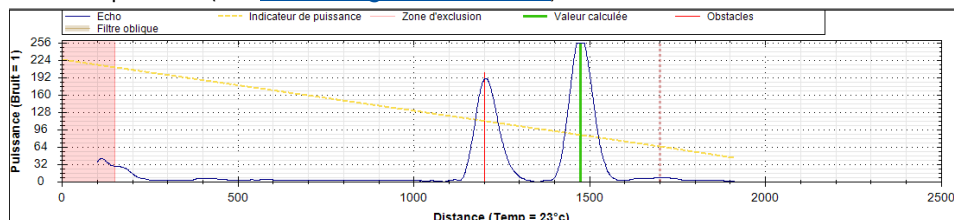

- Before applying a filter, check whether the positioning can be modified to obtain a cleaner measurement.

If this is not possible, and if the oblique filter is not applicable in the case where the obstacle is too close to the water, then you must create an “obstacle filter” which consists in masking the obstacles that interfere with the measurement such as fixed obstacles such as culverts or any other bars in the cone of the radar beam.

- Click on the “Advanced mode” button to display the processing parameters (1).
- Uncheck (2) the radar parameter: **Automatic signal scale**.

In this case, automatic display processing must remain inactive to prevent it from further amplifying the amplitude of the echo of the obstacle, which must remain constant regardless of the amplitude of the peak returned by the echo of the water (distance D in green).

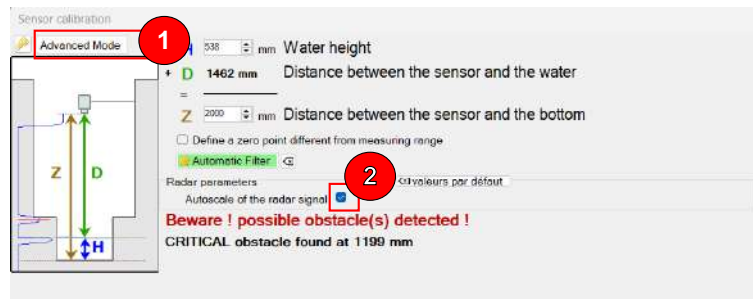

- Adjust the **gain** (3) so that the amplitude of the green echo is slightly above the power indicator (yellow line) and redo the measurement to refine the settings until you get a result as shown below.

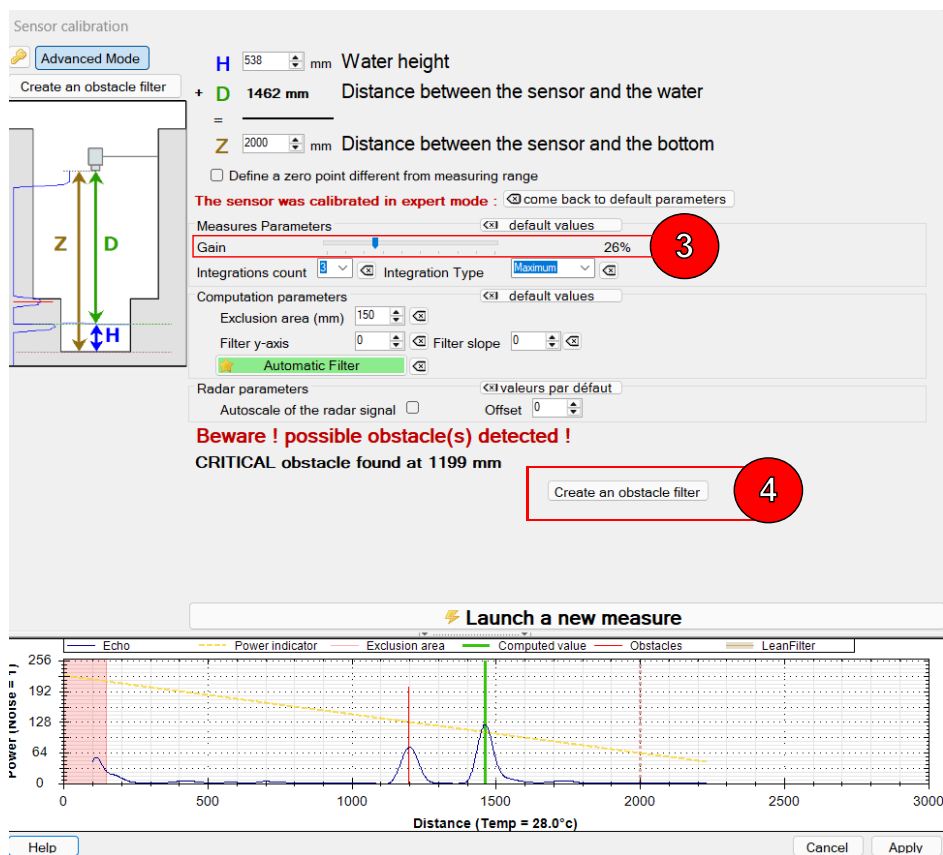

- Click on **Create an obstacle filter** (4).
- Select the echo of the obstacle to be filtered for the **obstacle** check box (5) and the echo of the distance measure D for the **measurement** check box (6).
- Click on “Create filter” (7).

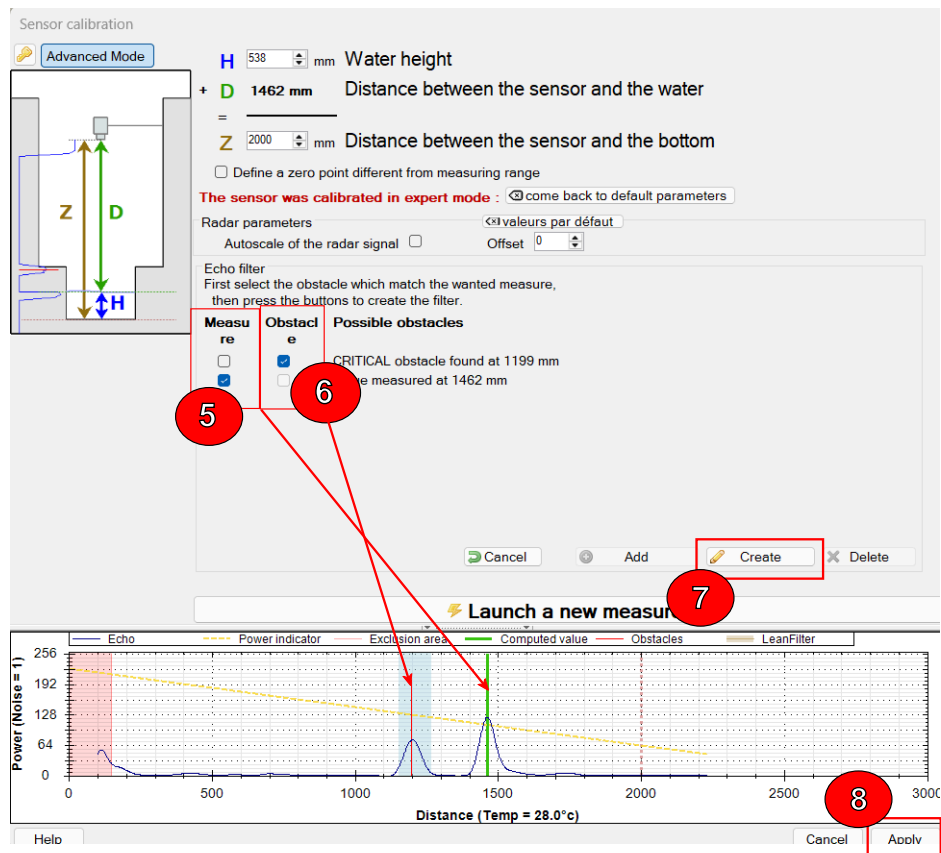

- Click on Validate (8) to apply the processing.

-> The obstacle echo is masked by a filter and appears in red on the graph.

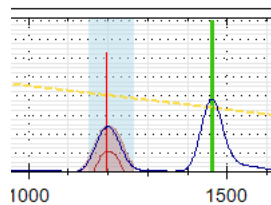

Filtered obstacle

Complex cases: expert mode

Expert mode is reserved for delicate cases requiring a certain level of expertise in data processing using ultrasonic or radar measurement. Numerous parameters are available. This activity is not detailed in this documentation. **Switching to expert mode is password-protected. Contact your correspondent or Ijinus if you need to use this expert mode, and we'll provide you with the password and explanations.**

Water level measurement configuration



Prerequisite: In Avelour, the Wiji connection to the logger must be established, see. [Connecting to a logger](#)

- Click on  to add a measurement configuration and select "Radar water height -> Flow".

Measure period

- Select a period between each measurement from the list. In the example above, a measurement will be taken every 15 minutes.

Debugging echoes (Advanced settings)

Debugging echoes are recorded when there are differences between two successive level measurements (on rise and/or descent: here 75 mm for both), the acoustic signature of the measurements, or ultrasound echoes (already detailed above). A posteriori examination will then enable us to diagnose the quality of level measurements and correct calibration to obtain more easily usable measurements. For first-time installations, or in the case of delicate points, we strongly advise you to activate this function.

Height value for loss of echo (Advanced settings)

In the field of ultrasound, echo loss means the absence of a peak (or a peak so weak that it is not detected as an obstacle) on the echoes, which is materialized by a maximum height, i.e. equal to the Z entered during calibration. When the sensor encounters this situation, this function replaces the erroneous "a priori" value with a value of the user's choice: last valid value, value to be defined, etc.

Although this function can be useful, it must be used judiciously and should not be used to compensate for unsuitable calibration.



Modifying the frequency of measurements on a measurement threshold

- Activate **change period on height threshold** to display the following configuration parameters:

Direction: Threshold on High Level or Low Level.

Changed period: New frequency of threshold measurements.

Height: Threshold to be reached to activate modification.

Hysteresis: Value to be subtracted (high level) or added (low level) to the threshold at which the measurement frequency returns to its initial value.

Minimum time before deceleration: Hold time for the new measurement frequency before returning to its initial value.

Example below: Measure period is reduced from 5 minutes to 10 seconds when the water level exceeds 1000 mm. When the water level falls below 800 mm for 1 minute, the measure period remains at 10 seconds, then returns to 5 minutes.

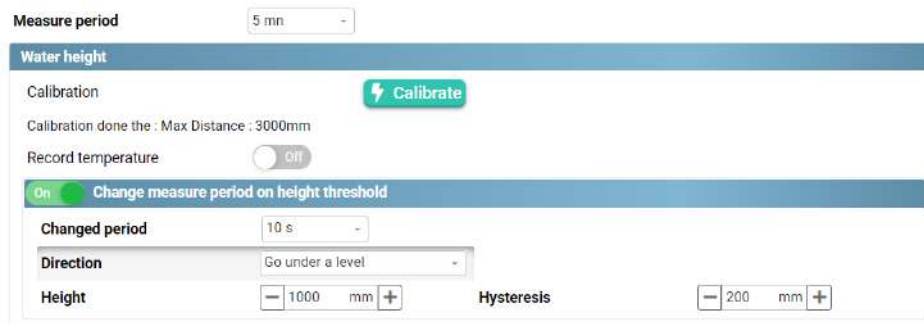

Defining an overflow threshold

Recording of an overflow file from a high or low level threshold can be activated .

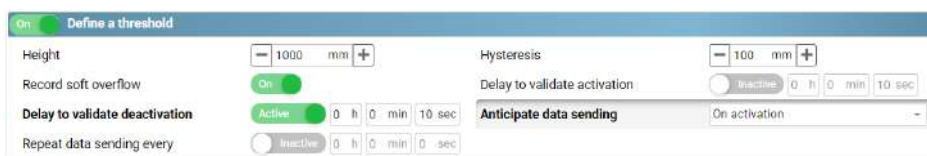

Height : Height threshold at which an overflow is set to 1.

Hysteresis: Value to be subtracted from the threshold at which the overflow state returns to 0.

Delay to validate activation: Time after which the overflow status changes to 1.

Delay to validate deactivation: Value to be subtracted from the threshold at which the overflow state returns to 0.

Anticipate data sending: Data transmission can be done when overflow status is activated, deactivated or both.

Repeat data sending every: If data transmission on activation is selected, this enables you to modify the data transmission period.



If anticipate data sending is enabled, then when the threshold is reached, an alert SMS is sent to an operator if the option is enabled (see [Sending an alert SMS](#)).

Example: If the height level exceeds 1000 mm for 1 minute, the overflow status changes to 1, and data are sent once, then a second time 10 minutes later. If the measured height falls below the 900 mm threshold for 1 minute, the overflow status returns to 0.

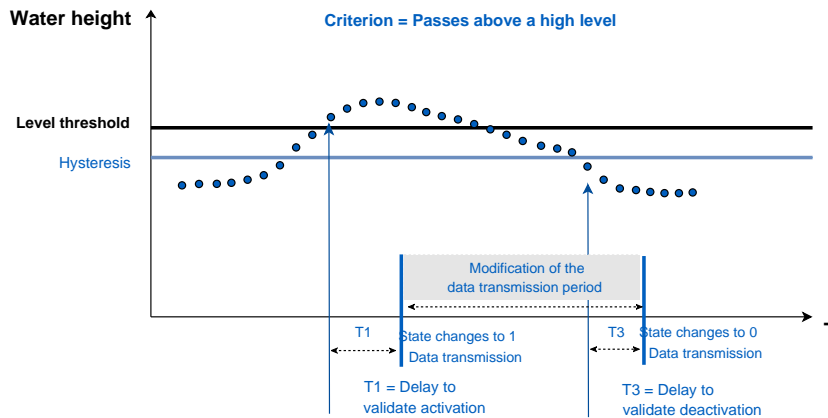

Record soft overflows

- Activate **software overflow recording** to record overflow states.

Recording channel (Advanced parameter)

- Click on to change the channel for recording overflow states.

Fifo Memory (Advanced Setting)

By default, when the logger memory is full, data are deleted in chronological order of recording, from oldest to newest.

- Click to display advanced settings.
- If Fifo memory is disabled, change the maximum number of timestamps for the main memory (used for sending data via Internet) and the auxiliary memory (used for sending data via SMS) if necessary.

Maximum records SMS Maximum records

Define a second threshold

This level threshold is used to force data transmission at a second defined height.

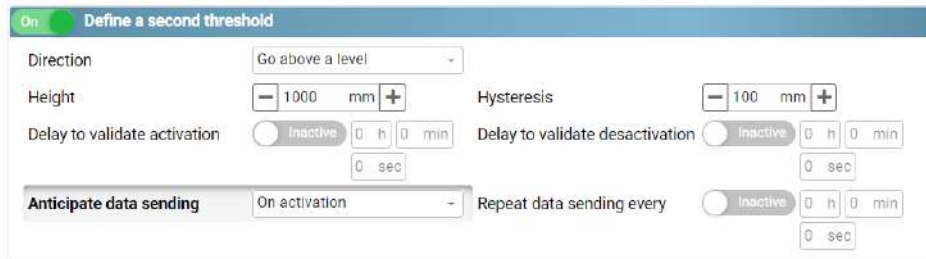

Direction: Define whether the measured level threshold passes **above a high level** or **below a low level**.

Height: Height threshold.

Hysteresis: Value to be subtracted (if high level) or added (if low level) to the threshold.

Delay to validate activation: Time after which the threshold is reached.

Delay to validate deactivation: Time after which the threshold is no longer reached.

Anticipate data sending: Data transmission can be forced on activation, deactivation or both.

Repeat data sending every: If data transmission on activation is selected, this enables you to modify the data transmission period.



If anticipate data sending is enabled, then when the threshold is reached, an alert SMS is sent to an operator if the option is enabled (see [Sending an alert SMS](#)).

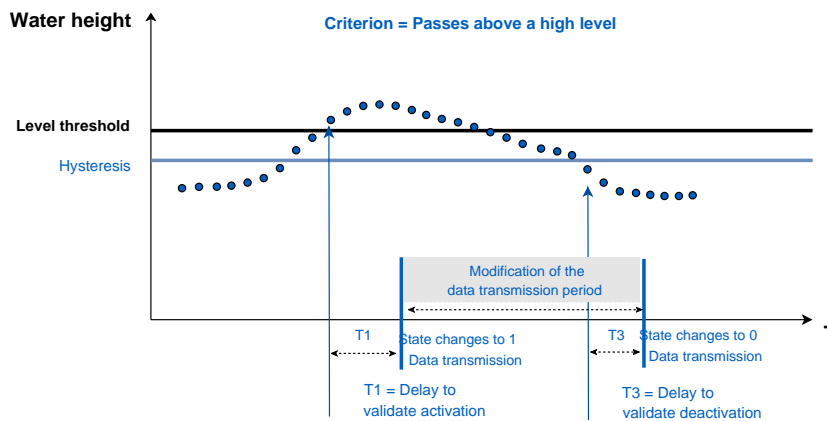

Flow

The calculation is possible, but the validity of the calculation depends on the quality of the height/flow relationship.

- To calculate the flow rate, please refer to the excel form available via the link on Avelour.
- Fill in the height/surface table by clicking on .



Volume



Cumulated volume Record cumulative volume on an hourly, daily or monthly basis.

Record infinite accumulation Activates cumulative volume recording indefinitely.

Sampler enslaving

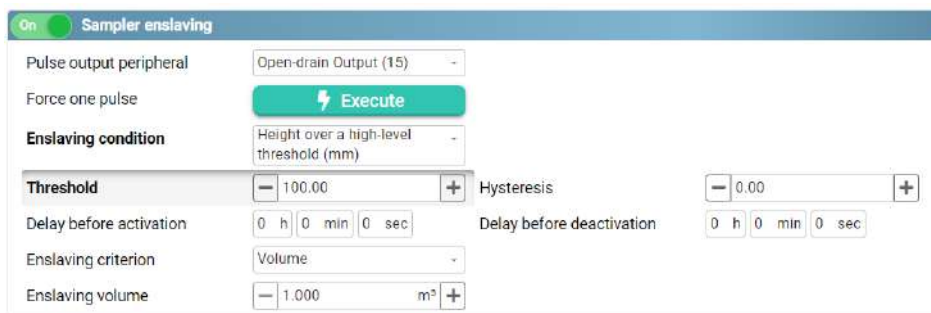

If a height/flow relation and an "infinite" volume calculation have been entered, then it is possible to activate the transmission of pulses to a sampler connected to an Ijinus logger.

- Select **pulse output peripheral**.
- Click the  button in front of the "Force one pulse" line to test the connection between logger and sampler. When you click this button, the logger sends a pulse to the Open-Drain output, which must be detected by the connected sampler.
- Select the **enslaving condition**: either on a water level or on flow.

If a condition is selected:

- Enter a **threshold** in mm and a **hysteresis** in mm for this condition. The **hysteresis** parameter defines a value to be subtracted from or added to the threshold for which the condition remains true.

Example: In the case of a slaving condition with a height above a high threshold of 100 mm and a hysteresis of 5 mm, the slaving condition remains active until the height drops below 95 mm.

- Enter a **delay** to this condition, for this condition, whether for activation or deactivation of pulses.

Two enslaving criteria are possible:

- **Volume**: This means that, in the example above, a pulse will be sent each time the logger has measured 1 m³ of transited volume.
- **Time**: This means that as long as the condition is active, a pulse will be sent to the sampler at the defined frequency. The measured flow rate has no effect on the number and frequency of pulses sent.



Between two measurements, the logger is in standby mode and cannot send pulses. At the time of measurement, if the logger calculates a transited volume of 5 m^3 for example, then five pulses will be sent in succession. Similarly, if the pulse frequency is set to one minute, but the measurement frequency is only five minutes, no pulses will be sent between two measurements. However, every time the unit is woken and if the slaving condition is still met, five pulses will be sent to the sampler every five minutes.

Configuration summary

To view the configuration summary:

- Click on [SEE OVERVIEW](#) to display a summary of the configuration.

Mapping table between DataID, channel & data

DataID	Channel	Data displayed	Units	Data Description	Data files
2	0	Debug (positive integer value)	-	Number of enslaving pulses	*_smpl.bin
3	7	Debug (signed integer value)	mAh	Internal battery current consumption	*_diag.bin
4	0	Debug (Real value)	-	Water flow (m^3/h)	*_radf.bin
6	0	Voltage	V	Instantaneous internal battery voltage (Res. 0.05 V)	*_diag.bin
6	1	Voltage	V	Minimum internal battery voltage reached (Res. 0.05 V)	*_diag.bin
12	0	Measure temperature	$^{\circ}\text{C}$	Sensor temperature measurement (Res. 0.1°C)	*_radf.bin
15	0	Material height	mm	Water Height	*_radf.bin
17	0	GSM signal Power	dBm	GSM signal power	*_diag.bin
19	0	Date	-	POSIX time	Asynchronous data
20	0-7	Overflow	-	Overflow status	*_ovsoft.bin
34	0	Flow	m^3/s	Water flow	*_radf.bin
36	0	Distance	mm	Sensor-Water distance	*_radf.bin
39	0	Volume	m^3	Cumulated volume	*_volcount.bin
39	1	Volume	m^3	Infinite volume	*_radf.bin
44	2	Angle	$^{\circ}$	Roll angle (Res. 0.1°)	*_angle.bin
44	3	Angle	$^{\circ}$	Longitudinal axis angle (Res. 0.1°)	*_angle.bin

9.6.3. Radar Water height -> OSRAI Flow

Principle

Radar is a system that uses electromagnetic (radio) waves to detect the presence and position of an object.

To measure the water level, the sensor is placed above the flow and emits short pulses towards the water surface. The waves are reflected by the water surface and returned to the sensor, which measures the time they take to travel. The travel time is directly proportional to the distance between the sensor and the water surface. Now that it knows the distance between the sensor and the bottom of the water, the sensor calculates the water height.

Radar calibration



For distance measurements of more than 6 metres, version 7.2 of Avelour is required and the firmware installed must at least version 23.5 (refer to paragraph [Firmware update](#)).



Prerequisites: In Avelour, the Wiji connection to the logger must be established, see [Connecting to a logger](#).



Before calibration, make sure the radar sensor is correctly positioned (see paragraph [Positioning a radar sensor](#)).

- Click on  to start radar sensor calibration.

-> A distance measurement is automatically started and the calibration window opens.

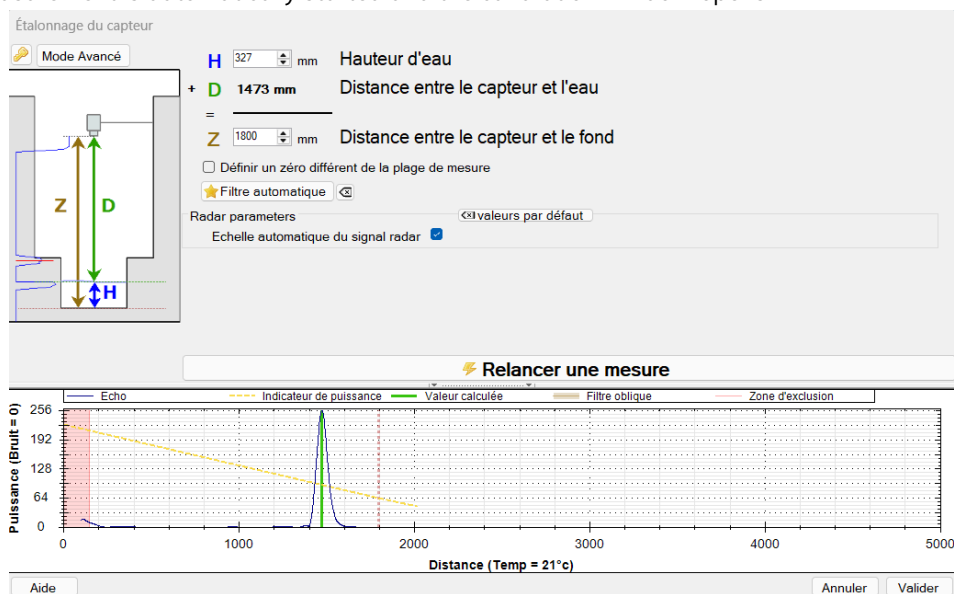

- Enter the distance between the sensor and the bottom and click on "Launch a new measure" to save the configuration changes on the sensor and view the result.

Echo graph

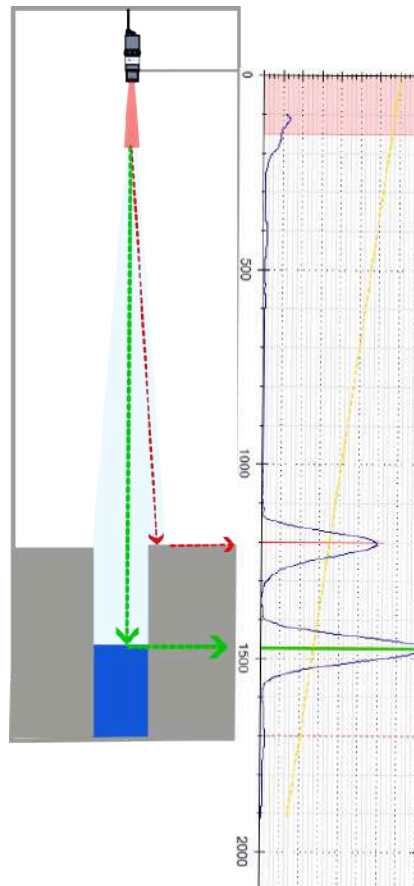

The graph displayed shows the echo of the radar wave returned:

- The peaks indicate where the sensor "detects" an obstacle.
- Red lines indicate whether obstacles are detected that could interfere with the measurement.
- The dotted red line indicates the Z configured.
- The shape at the start of the echo corresponds to the "blind" zone for the sensor, in which no measurements can be taken.
- The red zone corresponds to the sensor's blind zone filter, the brown zone to the oblique filter. These filters are defined in advanced mode.
- The green line indicates the obstacle which is considered the correct measurement by the sensor.
- The yellow line indicates the recommended level of measurement: The peak representing the correct measurement should be near this line.
- The advanced mode button provides additional echo filtering functions. The key button gives access to the expert settings.



You can zoom in on the graph using the mouse wheel.

- To restore the initial display, double-click on the graph.

Define a zero outside the measurement range

It is possible to define a "zero" level other than the culvert, particularly useful for storm overflows, for example, where it is possible to set the zero at the level of the overflow weir.

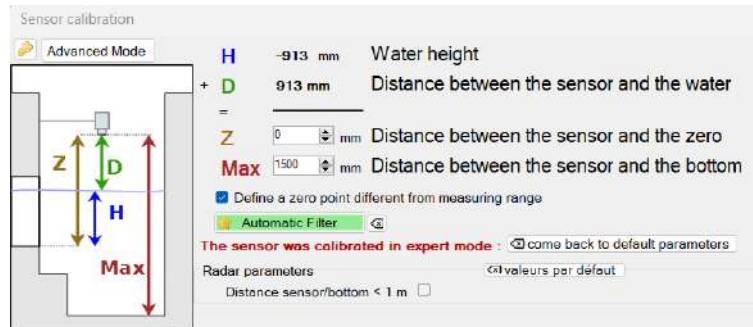

Advanced mode

Click on "Advanced mode" to display measurement and computation parameters.

Measurement parameters

Gain: Adjust the amplification when receiving the radar wave.

Number of integrations: Number of successive echoes emitted.

Type of integration: Echo processing, the "minimum", an "average" or the "maximum".

Computation parameters

Exclusion zone: Value in mm of the sensor blind zone.

Filter y-axis: Adjust the power of the filter.

Filter coefficient: Adjust the slope of the filter.

Radar settings

Automatic signal scale: Automatic adjustment of the radar signal display to full scale

Offset: Adjustment of the measured distance D to reach the actual distance.

Critical Obstacle echo processing: Apply an oblique filter

In case of a message: **ATTENTION! : Potential obstacle(s) detected**, insofar as possible you must modify the positioning of the sensor to correct the problem (see [Positioning a radar sensor](#)).

In the example below, a critical obstacle is detected (in red). It corresponds to a fixed obstacle near the sensor.

- Before applying a filter, check whether the positioning can be modified to obtain a cleaner measurement.

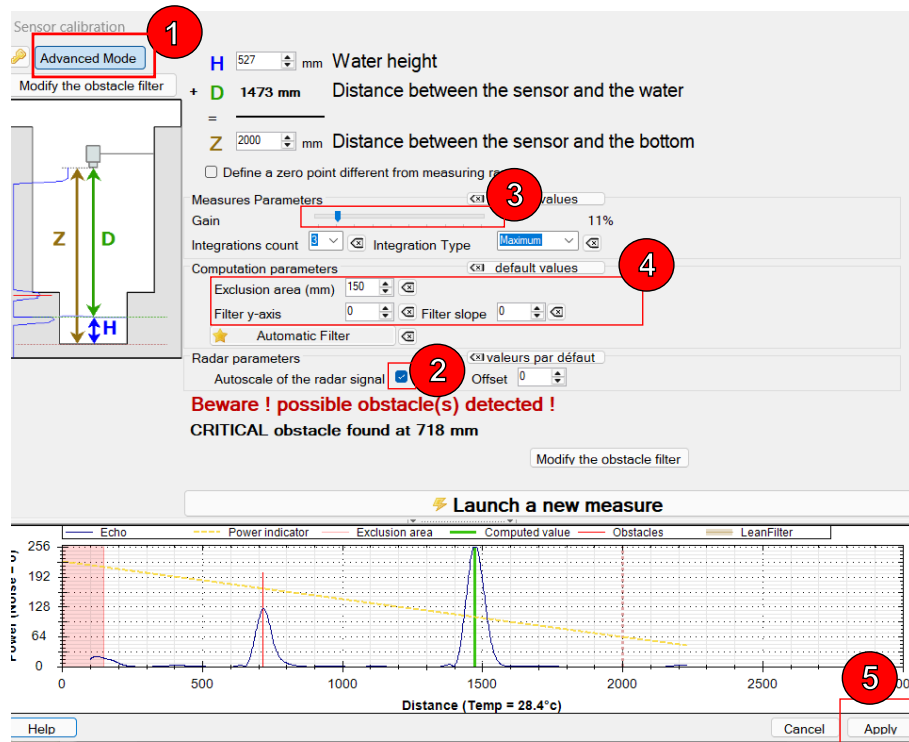

This echo can be processed using an oblique filter that can be configured as follows:

- Click on the “Advanced mode” button to display the processing parameters (1).
- Uncheck (2) the radar parameter: **Autoscale of the radar signal**.

In this case, automatic display processing must remain inactive to prevent it from further amplifying the amplitude of the echo of the obstacle, which must remain constant regardless of the amplitude of the peak returned by the echo of the water (distance D in green).

- Adjust the **gain** (3) so that the amplitude of the green peak is slightly above the power indicator (yellow line) and redo the measurement to refine the settings until you get a result as shown below.

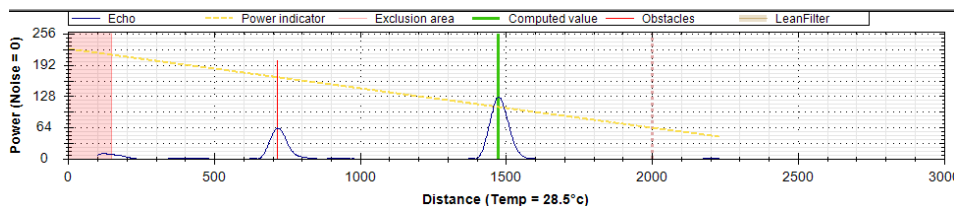

- Adjust the filter settings (4) to obtain a result similar to the example below.
 - Define filter power: **Filter y-axis**, equal to 220 in the case above.
 - Define its slope: **Filter slopet**, equal to 34 in the case above.

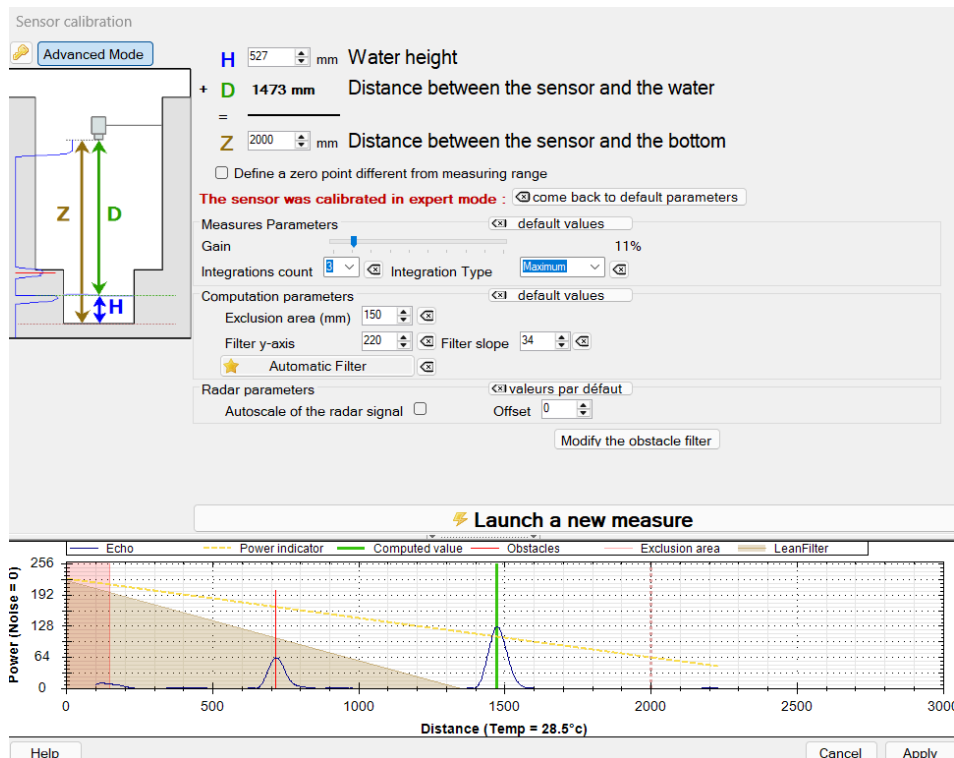

- Click on “Validate” (5) to apply the processing.

Critical obstacle echo processing: Apply an obstacle filter

In case of a message: **ATTENTION! : Potential obstacle(s) detected**, insofar as possible you must modify the positioning of the sensor to correct the problem (see [Positioning a radar sensor](#)).

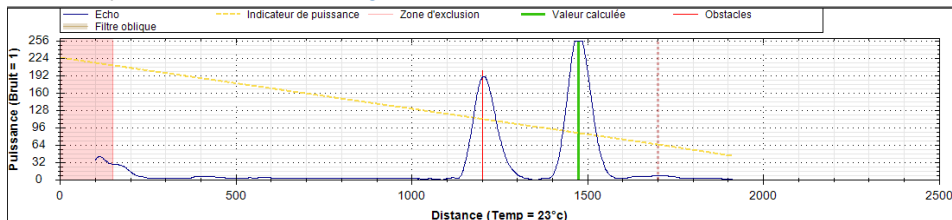

- Before applying a filter, check whether the positioning can be modified to obtain a cleaner measurement.

If this is not possible, and if the oblique filter is not applicable in the case where the obstacle is too close to the water, then you must create an “obstacle filter” which consists in masking the obstacles that interfere with the measurement such as fixed obstacles such as culverts or any other bars in the cone of the radar beam.

- Click on the “Advanced mode” button to display the processing parameters (1).
- Uncheck (2) the radar parameter: **Automatic signal scale**.

In this case, automatic display processing must remain inactive to prevent it from further amplifying the amplitude of the echo of the obstacle, which must remain constant regardless of the amplitude of the peak returned by the echo of the water (distance D in green).

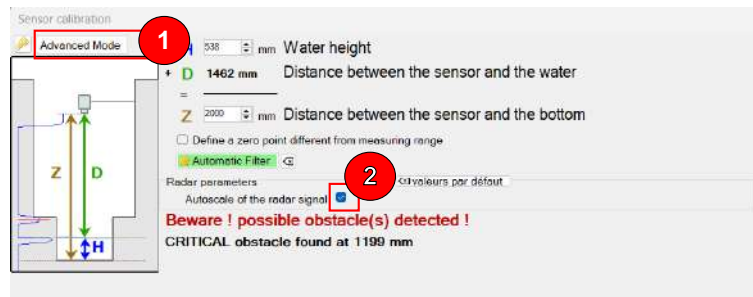

- Adjust the **gain** (3) so that the amplitude of the green echo is slightly above the power indicator (yellow line) and redo the measurement to refine the settings until you get a result as shown below.

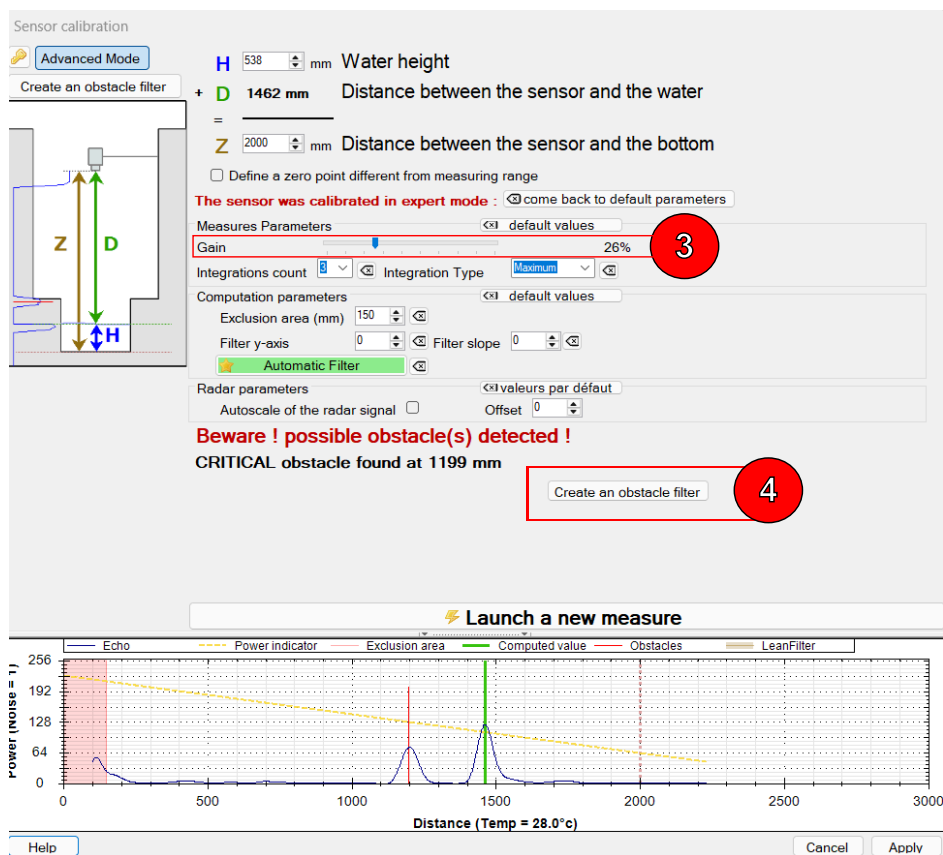

- Click on **Create an obstacle filter** (4).
- Select the echo of the obstacle to be filtered for the **obstacle** check box (5) and the echo of the distance measure D for the **measurement** check box (6).
- Click on “Create filter” (7).

- Click on Validate (8) to apply the processing.

-> The obstacle echo is masked by a filter and appears in red on the graph.

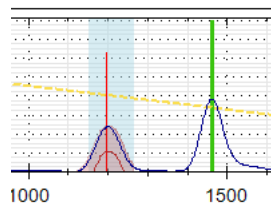

Filtered obstacle

Complex cases: expert mode

Expert mode is reserved for delicate cases requiring a certain level of expertise in data processing using ultrasonic or radar measurement. Numerous parameters are available. This activity is not detailed in this documentation. **Switching to expert mode is password-protected. Contact your correspondent or Ijinus if you need to use this expert mode, and we'll provide you with the password and explanations.**

Water level measurement configuration



Prerequisites: In Avelour, the Wiji connection to the logger must be established, see [Connecting to a logger](#).

- Click on  to add a measurement configuration and select "Radar Height -> Osrai Flow".

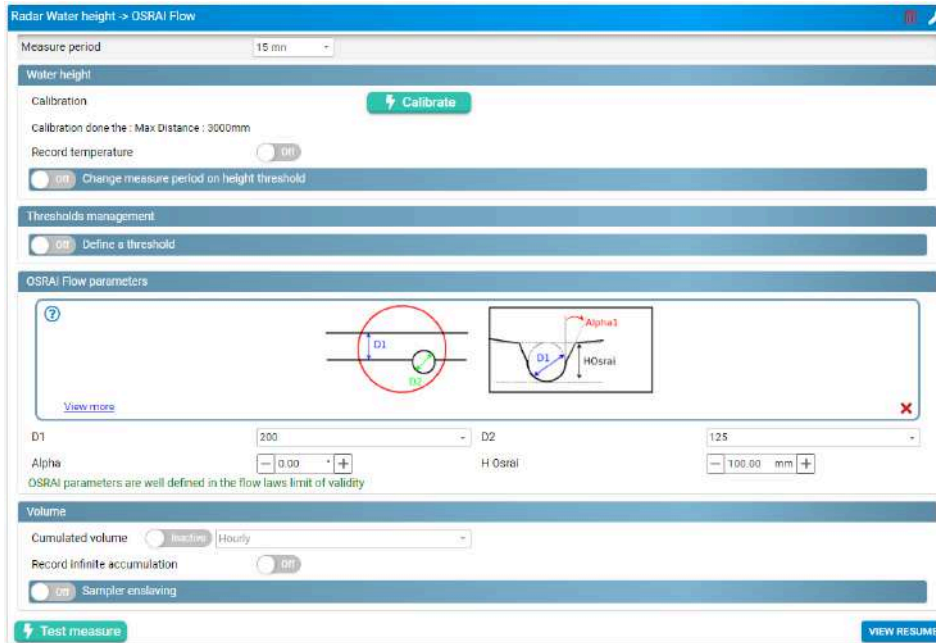

Measure period

- Select a period between each measurement from the list. In the example above, a measurement will be taken every 15 minutes.

Change measure period on height threshold

- Activate  **change measure period on height threshold** to display the following configuration parameters:

Changed period: New measurement frequency.

Direction: Threshold on high or low level.

Height : Threshold to be reached to activate modification.

Hysteresis: Value to be subtracted (high threshold) or added (low threshold) to the level at which the measurement frequency returns to its initial value.

Example: Measure period changes from 5 minutes to 10 seconds when the water level exceeds 1000 mm. When the water level falls below 800 mm, then returns to 5 minutes.

Measure period

Water height

Calibration

Calibration done the : Max Distance : 3000mm

Record temperature

On **Change measure period on height threshold**

Changed period

Direction

Height

Hysteresis

Defining an overflow threshold

Recording of an overflow file from a high or low level threshold can be activated .

On **Define a threshold**

Height

Hysteresis

Record soft overflow

Delay to validate activation

Anticipate data sending

Repeat data sending every

Height : Height threshold at which an overflow is set to 1.

Hysteresis: Value to be subtracted from the threshold at which the overflow state returns to 0.

Delay to validate activation: Time after which the overflow status changes to 1.

Delay to validate deactivation: Value to be subtracted from the threshold at which the overflow state returns to 0.

Anticipate data sending: Data transmission can be done when overflow status is activated, deactivated or both.

Repeat sending: If data transmission on activation is selected, this allows you to modify the data transmission period.



If anticipate data sending is enabled, then when the threshold is reached, an alert SMS is sent to an operator if the option is enabled (see [Sending an alert SMS](#)).

Example: If the height level exceeds 1000 mm for 1 minute, the overflow status changes to 1, and data are sent once, then a second time 10 minutes later. If the measured height falls below the 900 mm threshold for 1 minute, the overflow status returns to 0.

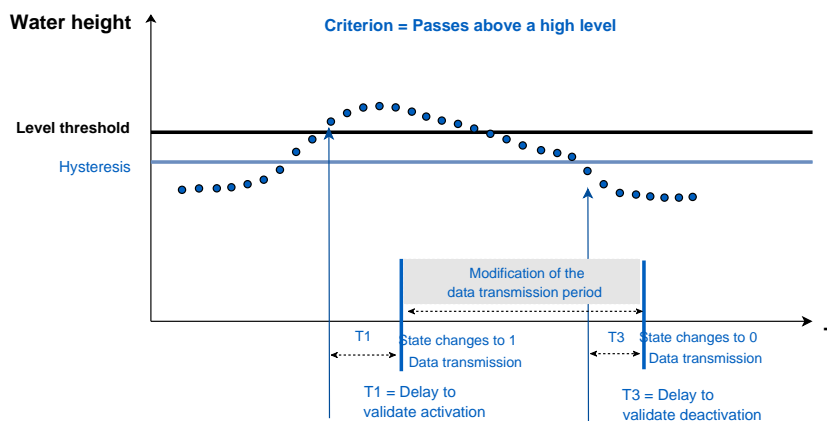

Record soft overflows

- Activate **software overflow recording** to record overflow states.

Recording channel (Advanced parameter)

- Define a channel between 1 and 7 if required.

Fifo Memory (Advanced Setting)

By default, when the logger memory is full, data are deleted in chronological order of recording, from oldest to newest.

- Click  to display advanced settings.
- If Fifo memory is disabled, change the maximum number of timestamps for the main memory (used for sending data via Internet) and the auxiliary memory (used for sending data via SMS) if necessary.

Maximum records SMS Maximum records

Define a second threshold

This level threshold is used to force data transmission at a second defined height.

Define a second threshold

Direction:

Height: mm

Hysteresis: mm

Delay to validate activation: Inactive h min sec

Delay to validate deactivation: Inactive h min sec

Anticipate data sending:

Repeat data sending every: Inactive h min sec

Direction: Defines whether the measured level threshold passes **above a high level** or **below a low level**.

Height: Height threshold.

Hysteresis: Value to be subtracted from / added to the threshold.

Delay to validate activation: Time after which the threshold is reached.

Delay to validate deactivation: Time after which the threshold is no longer reached.

Anticipate data sending: Data can be sent on activation, deactivation or both.

Repeat data sending every: If data transmission on activation is selected, this enables you to modify the data transmission period.



If anticipate data sending is enabled, then when the threshold is reached, an alert SMS is sent to an operator if the option is enabled (see [Sending an alert SMS](#)).

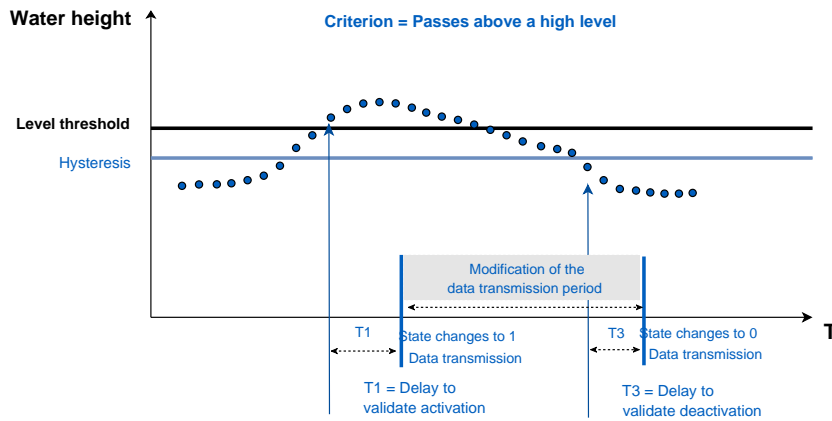

Configuration of Osrai flow installation

See paragraph [Installing the OSRAI system](#).



- Enter the values for **D1**, **D2**, **Alpha** and **HOsrai** as measured on the culvert.

If the section width check ($D1 \text{ actual} - D2 \text{ actual} / 2$) differs from the choices available in the software by +/- 3 mm, please consult us. We are able to provide you with a custom relation to achieve the correct flow rate and configure the sensor in another way.

Volume





Cumulated volume Record cumulative volume on an hourly, daily or monthly basis.

Record infinite accumulation Activates cumulative volume recording indefinitely.

Sampler enslaving

It is possible to control a sampler using the **open-drain output** or the **direct external power supply output V_{out}** of the logger. In the example below, the logger sends a pulse to the sampler each time a volume of 1 cubic meter is calculated.

- Test the slaving by clicking on .



Configuration summary

To view the configuration summary:

- Click on [SEE OVERVIEW](#) to display a summary of the configuration.

Radar Water height -> OSRAI Flow

Water height measure every
Maximum height **3000mm**
echoes record
Changed period is the same that the normal period
Recording will last for about (with second period) / Send around NaN SMS each day (NaN with second period)

 Test measure
[EDIT](#)

Mapping table between DataID, channel & data

DataId	Channel	Data displayed	Units	Data Description	Data files
3	7	Debug (signed integer value)	mAh	Internal battery current consumption	*_diag.bin

DataId	Channel	Data displayed	Units	Data Description	Data files
6	0	Voltage	V	Instantaneous internal battery voltage (Res. 0.05 V)	*_diag.bin
6	1	Voltage	V	Minimum internal battery voltage reached (Res. 0.05 V)	*_diag.bin
12	0	Measure temperature	°C	Sensor temperature measurement (Res. 0.1°C)	*_radf.bin
15	0	Material height	mm	Water Height	*_radf.bin
17	0	GSM signal Power	dBm	GSM signal power	*_diag.bin
19	0	Date	-	POSIX time	Asynchronous data
20	0-7	Overflow	-	Overflow status	*_ovsoft.bin
34	0	Flow	m ³ /s	Water flow	*_radf.bin
36	0	Distance	mm	Sensor-Water distance	*_radf.bin
39	0	Volume	m ³	Cumulated volume	*_volcount.bin
39	1	Volume	m ³	Infinite volume	*_radf.bin
44	2	Angle	°	Roll angle (Res. 0.1°)	*_angle.bin
44	3	Angle	°	Longitudinal axis angle (Res. 0.1°)	*_angle.bin

9.6.4. Radar Water height + external velocity -> Flow

Principle

Radar is a system that uses electromagnetic (radio) waves to detect the presence and position of an object.

To measure the water level, the sensor is placed above the flow and emits short pulses towards the water surface. The waves are reflected by the water surface and returned to the sensor, which measures the time they take to travel. The travel time is directly proportional to the distance between the sensor and the water surface. Now that it knows the distance between the sensor and the bottom of the water, the sensor calculates the water height.

This configuration is used if a velocity sensor is connected to the LNR, or if connected to another logger and paired with the LNR.

Radar calibration



For distance measurements of more than 6 metres, version 7.2 of Avelour is required and the firmware installed must at least version 23.5 (refer to paragraph [Firmware update](#)).



Prerequisites: In Avelour, the Wiji connection to the logger must be established, see [Connecting to a logger](#).



Before calibration, make sure the radar sensor is correctly positioned (see paragraph [Positioning a radar sensor](#)).

- Click on  to start radar sensor calibration.

-> A distance measurement is automatically started and the calibration window opens.

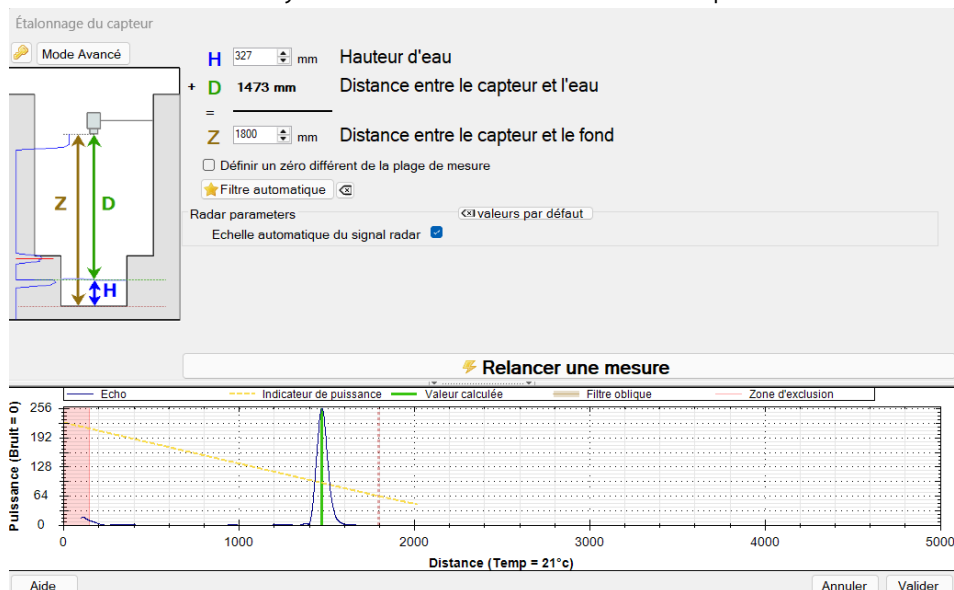

- Enter the distance between the sensor and the bottom and click on "Launch a new measure" to save the configuration changes on the sensor and view the result.

Echo graph

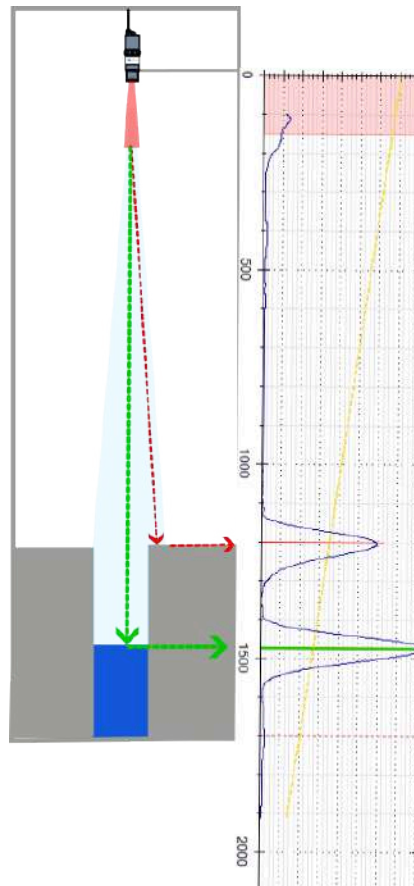

The graph displayed shows the echo of the radar wave returned:

- The peaks indicate where the sensor "detects" an obstacle.
- Red lines indicate whether obstacles are detected that could interfere with the measurement.
- The dotted red line indicates the Z configured.
- The shape at the start of the echo corresponds to the "blind" zone for the sensor, in which no measurements can be taken.
- The red zone corresponds to the sensor's blind zone filter, the brown zone to the oblique filter. These filters are defined in advanced mode.
- The green line indicates the obstacle which is considered the correct measurement by the sensor.
- The yellow line indicates the recommended level of measurement: The peak representing the correct measurement should be near this line.
- The advanced mode button provides additional echo filtering functions. The key button gives access to the expert settings.



You can zoom in on the graph using the mouse wheel.

- To restore the initial display, double-click on the graph.

Define a zero outside the measurement range

It is possible to define a "zero" level other than the culvert, particularly useful for storm overflows, for example, where it is possible to set the zero at the level of the overflow weir.

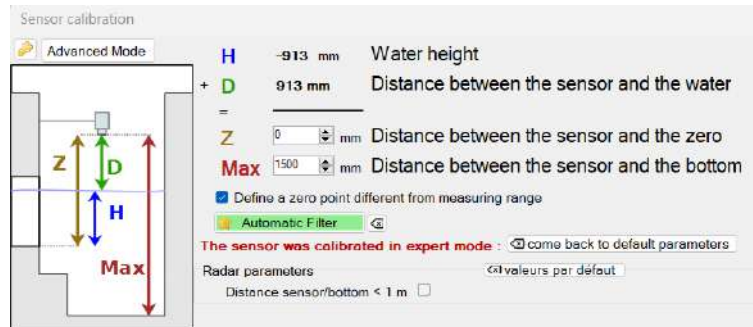

Advanced mode

Click on "Advanced mode" to display measurement and computation parameters.

Measurement parameters

Gain: Adjust the amplification when receiving the radar wave.

Number of integrations: Number of successive echoes emitted.

Type of integration: Echo processing, the "minimum", an "average" or the "maximum".

Computation parameters

Exclusion zone: Value in mm of the sensor blind zone.

Filter y-axis: Adjust the power of the filter.

Filter coefficient: Adjust the slope of the filter.

Radar settings

Automatic signal scale: Automatic adjustment of the radar signal display to full scale

Offset: Adjustment of the measured distance D to reach the actual distance.

Critical Obstacle echo processing: Apply an oblique filter

In case of a message: **ATTENTION! : Potential obstacle(s) detected**, insofar as possible you must modify the positioning of the sensor to correct the problem (see [Positioning a radar sensor](#)).

In the example below, a critical obstacle is detected (in red). It corresponds to a fixed obstacle near the sensor.

- Before applying a filter, check whether the positioning can be modified to obtain a cleaner measurement.

This echo can be processed using an oblique filter that can be configured as follows:

- Click on the “Advanced mode” button to display the processing parameters (1).
- Uncheck (2) the radar parameter: **Autoscale of the radar signal**.

In this case, automatic display processing must remain inactive to prevent it from further amplifying the amplitude of the echo of the obstacle, which must remain constant regardless of the amplitude of the peak returned by the echo of the water (distance D in green).

- Adjust the **gain** (3) so that the amplitude of the green peak is slightly above the power indicator (yellow line) and redo the measurement to refine the settings until you get a result as shown below.

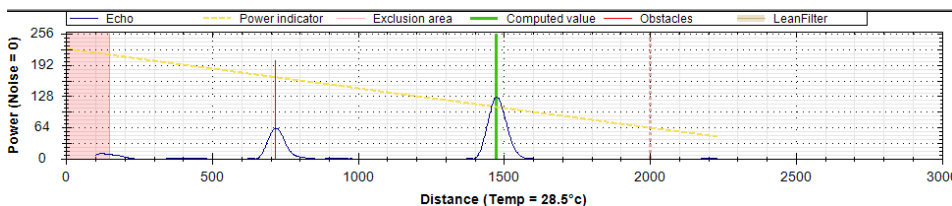

- Adjust the filter settings (4) to obtain a result similar to the example below.
 - Define filter power: **Filter y-axis**, equal to 220 in the case above.
 - Define its slope: **Filter slopet**, equal to 34 in the case above.

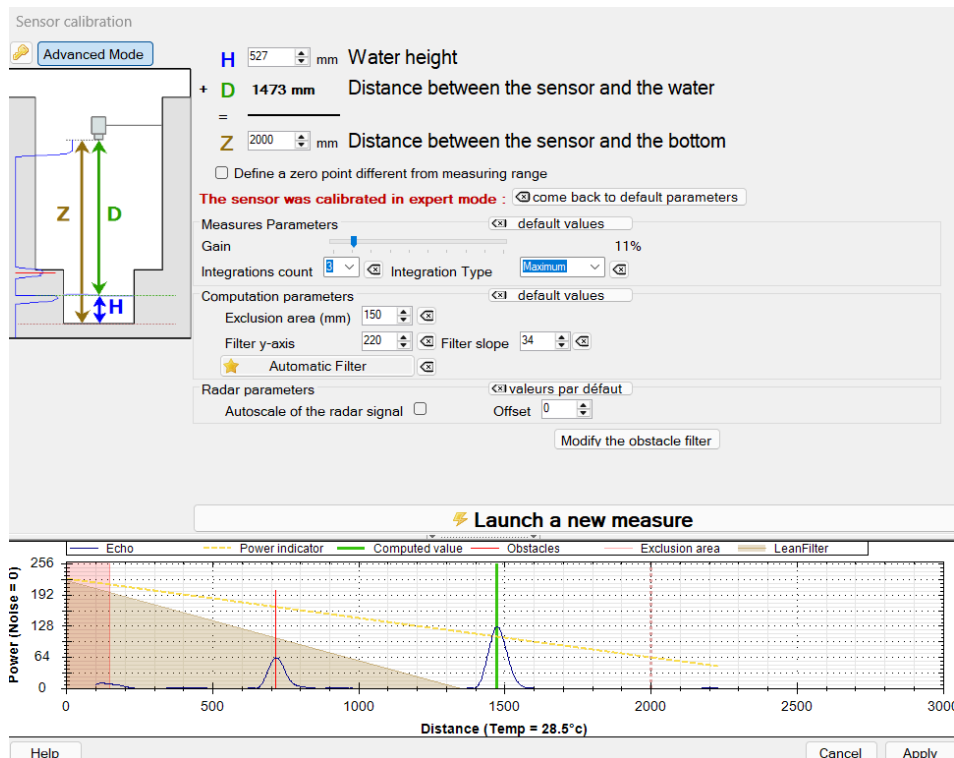

- Click on “Validate” (5) to apply the processing.

Critical obstacle echo processing: Apply an obstacle filter

In case of a message: **ATTENTION! : Potential obstacle(s) detected**, insofar as possible you must modify the positioning of the sensor to correct the problem (see [Positioning a radar sensor](#)).

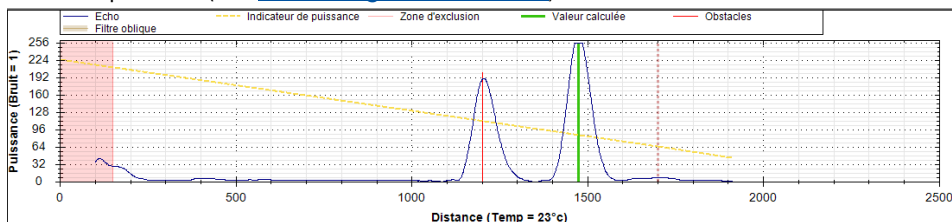

- Before applying a filter, check whether the positioning can be modified to obtain a cleaner measurement.

If this is not possible, and if the oblique filter is not applicable in the case where the obstacle is too close to the water, then you must create an “obstacle filter” which consists in masking the obstacles that interfere with the measurement such as fixed obstacles such as culverts or any other bars in the cone of the radar beam.

- Click on the “Advanced mode” button to display the processing parameters (1).
- Uncheck (2) the radar parameter: **Automatic signal scale**.

In this case, automatic display processing must remain inactive to prevent it from further amplifying the amplitude of the echo of the obstacle, which must remain constant regardless of the amplitude of the peak returned by the echo of the water (distance D in green).

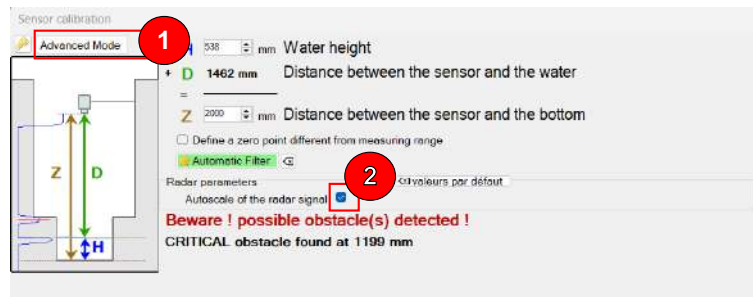

- Adjust the **gain** (3) so that the amplitude of the green echo is slightly above the power indicator (yellow line) and redo the measurement to refine the settings until you get a result as shown below.

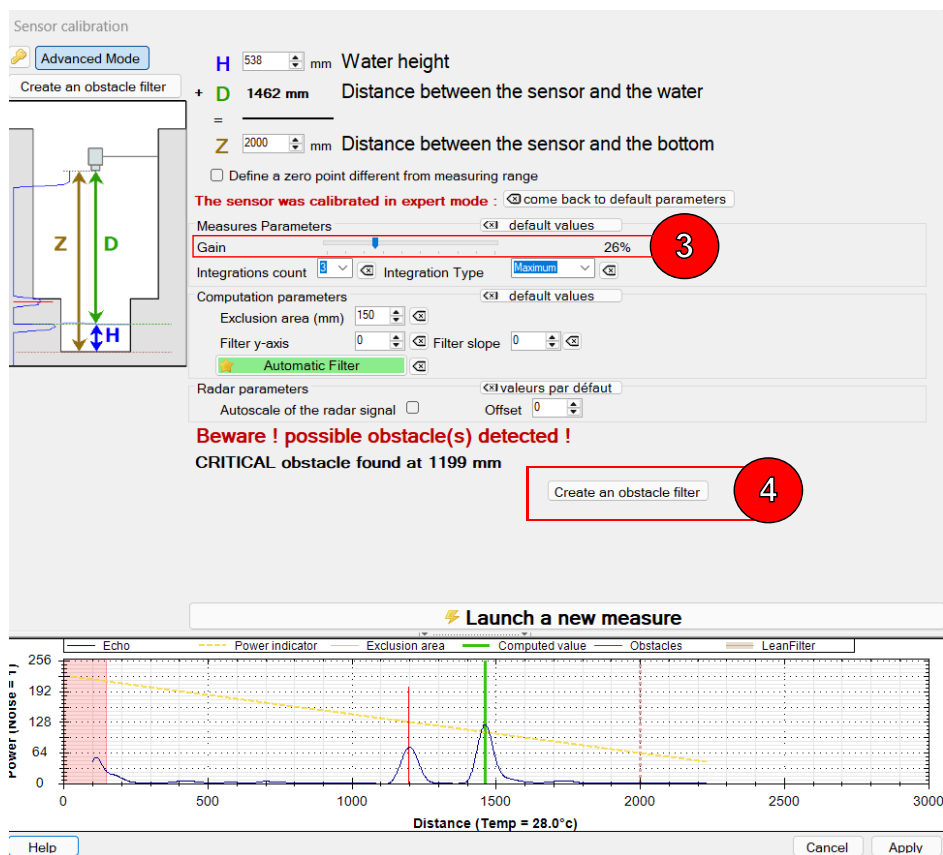

- Click on **Create an obstacle filter** (4).
- Select the echo of the obstacle to be filtered for the **obstacle** check box (5) and the echo of the distance measure D for the **measurement** check box (6).
- Click on “Create filter” (7).

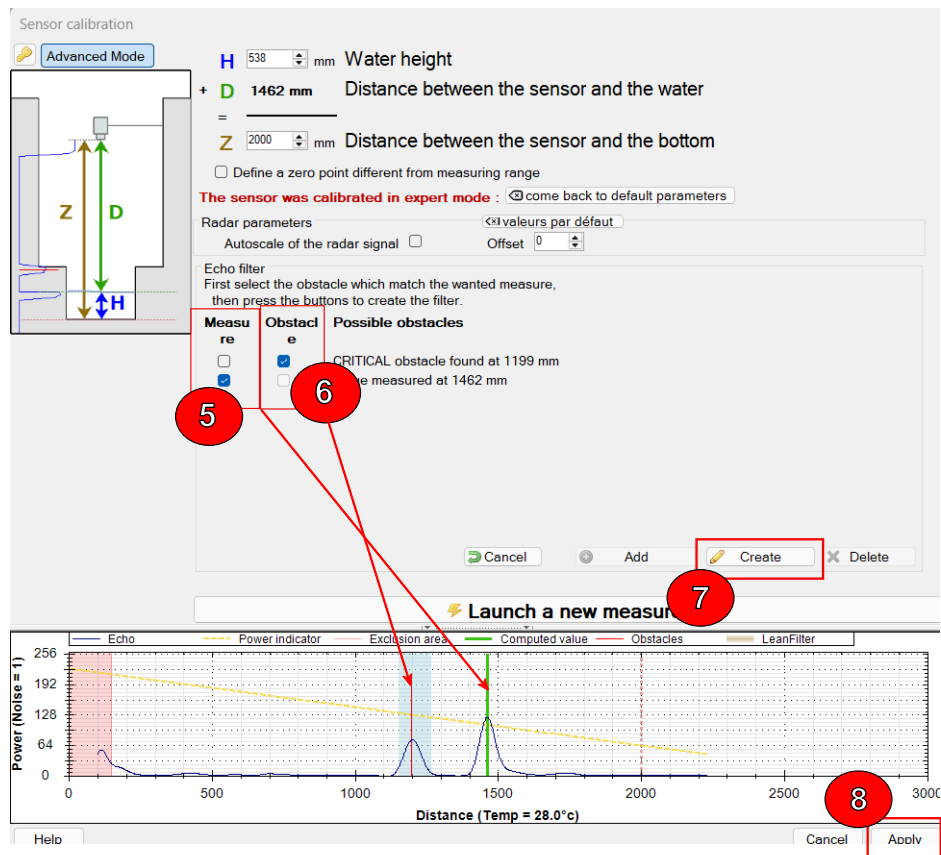

- Click on Validate (8) to apply the processing.

-> The obstacle echo is masked by a filter and appears in red on the graph.

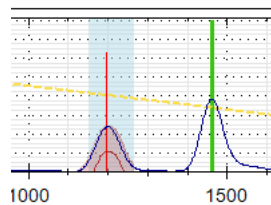

Filtered obstacle

Complex cases: expert mode

Expert mode is reserved for delicate cases requiring a certain level of expertise in data processing using ultrasonic or radar measurement. Numerous parameters are available. This activity is not detailed in this documentation. **Switching to expert mode is password-protected. Contact your correspondent or Ijinus if you need to use this expert mode, and we'll provide you with the password and explanations.**

Water level measurement configuration



Prerequisites: In Avelour, the Wiji connection to the logger must be established, see [Connecting to a logger](#).

- Click on  to add a measurement configuration and select "Radar water level + external velocity -> Flow".

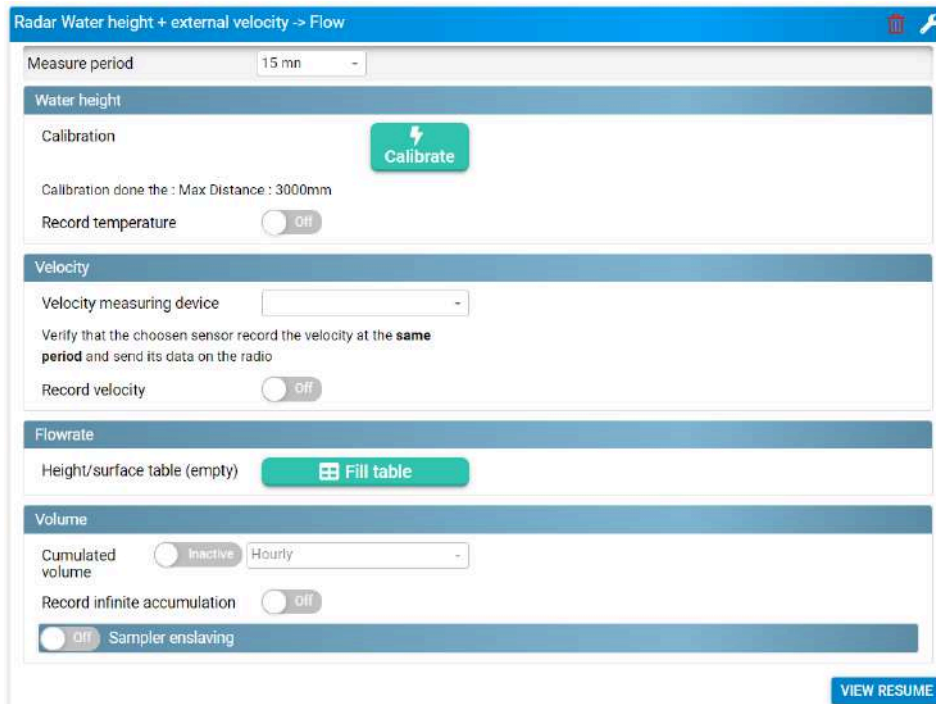

Measure period

- Select a period between each measurement from the list. In the example above, a measurement will be taken every 15 minutes.

Modifying the frequency of measurements on a measurement threshold

- Activate  if necessary, **change period on height threshold** to display the following configuration parameters:

Changed period: New frequency of threshold measurements. **Direction:** Threshold on a high or low level.

Height: Threshold to be reached to activate modification. **Hysteresis:** Value to be subtracted (high level) or added (low level) to the threshold at which the measurement frequency returns to its initial value.

Minimum time before deceleration: Hold time for the new measurement frequency before returning to its initial value.

Example below: Measure period is reduced from 5 minutes to 10 seconds when the water level exceeds 1000 mm. When the water level falls below 800 mm for 1 minute, the measure period remains at 10 seconds, then returns to 5 minutes.

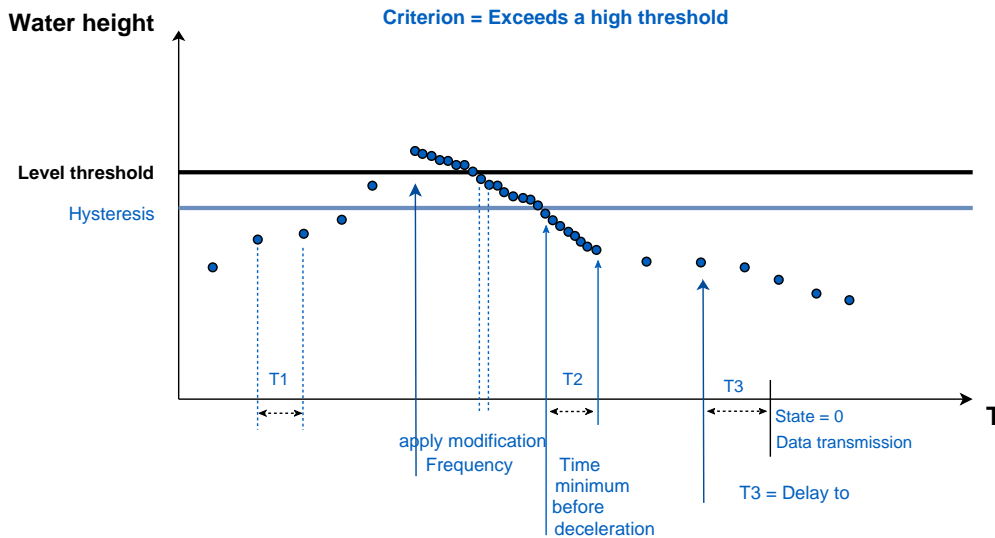

Defining an overflow threshold

A change in measure period can be activated using a high or low level threshold .

Height : Level threshold at which overflow status changes to 1.

Hysteresis: Value to be subtracted from the threshold at which the overflow state returns to 0.

Delay to validate activation: Determines the time after which the overflow state changes to 1, once the threshold has been exceeded.

Delay to validate deactivation: Time after which overflow status changes to 0.

Anticipate data sending: Data transmission can be forced on activation of overflow status, deactivation of overflow status or both.

Repeat data sending every: If data transmission on activation is selected, this enables you to modify the data transmission period.



If anticipate data sending is enabled, then when the threshold is reached, an alert SMS is sent to an operator if the option is enabled (see [Sending an alert SMS](#)).

Example: If the height level exceeds 1000 mm for 1 minute, the overflow status changes to 1, and data are sent once, then a second time 10 minutes later. If the measured height falls below the 900 mm threshold for 1 minute, the overflow status returns to 0.

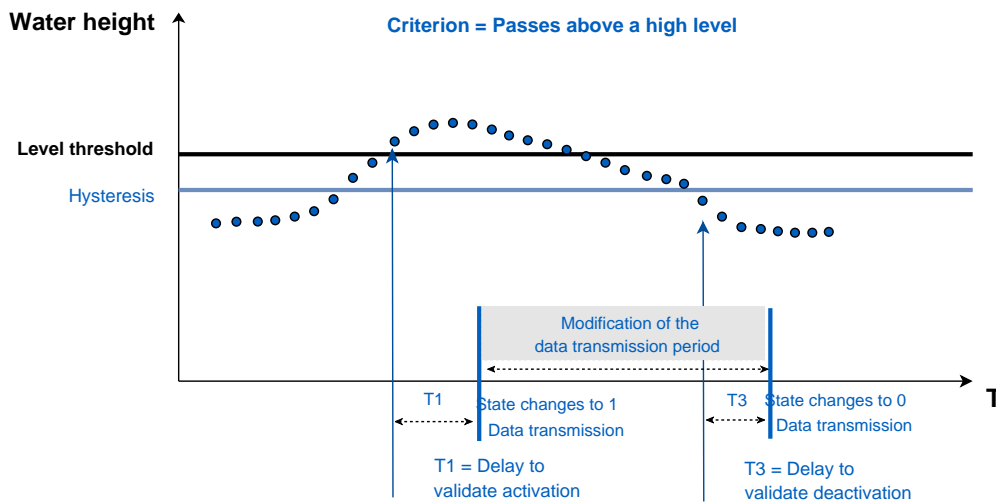

Record soft overflows

Fifo Memory (Advanced Setting)

By default, when the logger memory is full, data are deleted in chronological order of recording, from oldest to newest.

- Click  to display advanced settings.
- If Fifo memory is disabled, change the maximum number of timestamps for the main memory (used for sending data via Internet) and the auxiliary memory (used for sending data via SMS) if necessary.

Maximum records SMS Maximum records

Define a second threshold

On Define a second threshold

Direction:

Height: mm

Hysteresis: mm

Delay to validate activation: Inactive h min sec

Delay to validate deactivation: Inactive h min sec

Anticipate data sending: Repeat data sending every: Inactive h min sec

Direction: Defines whether the measured level threshold passes **above a high level** or **below a low level**.

Height: Height threshold.

Hysteresis: Value to be subtracted from (if high level) or added to (if low level) the threshold.

Delay to validate activation: Time after which the threshold is reached.

Delay to validate deactivation: Time after which the threshold is no longer reached.

Anticipate data sending: Data transmission can be forced on activation, deactivation or both.

Repeat data sending every: If data transmission on activation is selected, this enables you to modify the data transmission period.



If anticipate data sending is enabled, then when the threshold is reached, an alert SMS is sent to an operator if the option is enabled (see [Sending an alert SMS](#)).

Velocity - Case of a sensor connected to another logger



Make sure the sensor you choose to record velocity is set to **same cycle** of data transmission over the RF.

- Select the logger configured for velocity measurement from the list.
- Activate velocity recording if required.

Flow - Case of a sensor connected directly to the LNR

- To calculate wet surface area, please refer to the excel form available via the link on Avelour.
- Fill in the height/surface table by clicking on .

Volume

Cumulated volume Record cumulative volume on an hourly, daily or monthly basis.

Record infinite accumulation Activates cumulative volume recording indefinitely.

Sampler enslaving

It is possible to control a sampler using the **open-drain output** or the **direct external power supply output Vout** of the logger. In the example below, the logger sends a pulse to the sampler each time a volume of 1 cubic meter is calculated.

- Test the slaving by clicking on  which forces a pulse to be sent.

Configuration summary

To view the configuration summary:

- Click on **SEE OVERVIEW** to display a summary of the configuration.

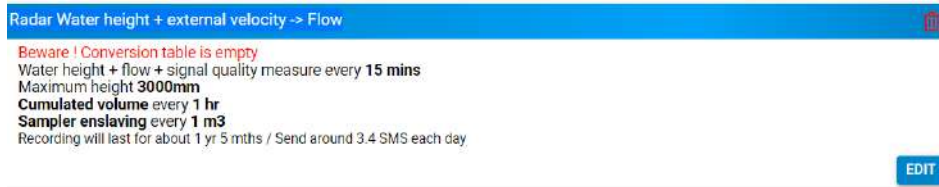

Mapping table between DataID, channel & data

DataId	Channel	Data displayed	Units	Data Description	Data files
3	7	Debug (signed integer value)	mAh	Internal battery current consumption	*_diag.bin
6	0	Voltage	V	Instantaneous internal battery voltage (Res. 0.05 V)	*_diag.bin
6	1	Voltage	V	Minimum internal battery voltage reached (Res. 0.05 V)	*_diag.bin
12	0	Measure temperature	°C	Sensor temperature measurement (Res. 0.1°C)	*_radflow.bin
15	0	Material height	mm	Water Height	*_radflow.bin
17	0	GSM signal Power	dBm	GSM signal power	*_diag.bin
19	0	Date	-	POSIX time	Asynchronous data
24	0	Velocity	mm/s	Flow velocity	*_radflow.bin
25	0	Doppler signal quality	%	Doppler signal quality	*_radflow.bin
34	0	Flow	m ³ /s	Water flow	*_radflow.bin
36	0	Distance	mm	Sensor-Water distance	*_radflow.bin
39	0	Volume	m ³	Cumulated volume	*_volcount.bin
39	1	Volume	m ³	Infinite volume	*_radflow.bin
44	2	Angle	°	Roll angle (Res. 0.1°)	*_angle.bin
44	3	Angle	°	Longitudinal axis angle (Res. 0.1°)	*_angle.bin

9.6.5. Radar Water height + RAVEN-EYE Radar

Principle

The Raven Eye velocity sensor is a Radar surface/velocity flowmeter. It is placed in the opposite direction to the flow by default and its principle is to measure the surface velocities of the flow. If the flow is extremely "smooth", with no "ripples", the measurement technology will reach its limit. Please refer to the manufacturer's documentation for further details. If provided with a water level, this product is also (within the limits of the documentation) capable of calculating (by describing the pipe profile) the average flow velocity and then the flow rate.

When combined with its LNR radar water level sensor, the sensor works as follows:

- The LNU measures a water level,
- then starts the Raven Eye ® measurement cycle (which lasts around 40 seconds).
- During the cycle, the water level is supplied to the Raven Eye ®.
- At the end of the process, and if all the quality criteria intrinsic to the Raven Eye ® are satisfied, the LNU retrieves all the data (height, speed, flow and quality indicators) and archives, presents or sends them to a supervision system.

Communication between the LNU and the Raven Eye ® is wired and uses Modbus Ascii.

Prerequisite

Le capteur de vitesse radar doit être paramétré sur site avec le logiciel du constructeur (Fuzion) et particulièrement le profil de la canalisation et l'ajustement des seuils des paramètres de qualité. Ensuite seulement, le capteur de hauteur LNR doit être paramétré car c'est lui qui pilotera la mesure de vitesse, la mesure de hauteur, les différents calculs et l'envoi des données.

The radar velocity sensor must be configured on-site using the manufacturer's software (Fuzion), with particular attention to the pipeline profile and the adjustment of quality parameter thresholds. Only then should the LNR height sensor be configured, as it will control the velocity measurement, the height measurement, the various calculations, and data transmission.



The Raven-Eye sensor must be version v0.24 or v0.27 (note that in batch processing mode, as in this system, v0.24 does not support the use of median filters on the data, whereas v0.27 does)

Installation

- The Raven-Eye velocity sensor is properly installed in the pipe where flow is to be measured: install the radar so that its beam enters the upstream pipe; adjust the mounting plate according to the diameter of the upstream pipe; the spirit level ensures a default inclination of 35° from the horizontal
- The LNR radar level sensor is properly installed to measure the water level in the pipe whose flow rate is to be measured.
- Both the Raven-Eye sensor and the LNR sensor are connected to the power supply unit

Configuration

The Raven-eye sensor is configured using the Fuzion software.



- Set the unit settings for the device: velocity must be in **m/s** and flow rate in **m³/s**
- For the Raven Eye to measure correctly, its '**Median Filter for Level**' setting must be set to **0**.
- Velocity choice : **vAGV**.

Water level configuration

Measurement period

- Select a period between each measurement from the list. Set to **stop** to use Test and diagnostic buttons.

Radar calibration



For distance measurements of more than 6 metres, version 7.2 of Avelour is required and the firmware installed must at least version 23.5 (refer to paragraph [Firmware update](#)).



Prerequisites: In Avelour, the Wiji connection to the logger must be established, see [Connecting to a logger](#).



Before calibration, make sure the radar sensor is correctly positioned (see paragraph [Positioning a radar sensor](#)).

- Click on  to start radar sensor calibration.

-> A distance measurement is automatically started and the calibration window opens.

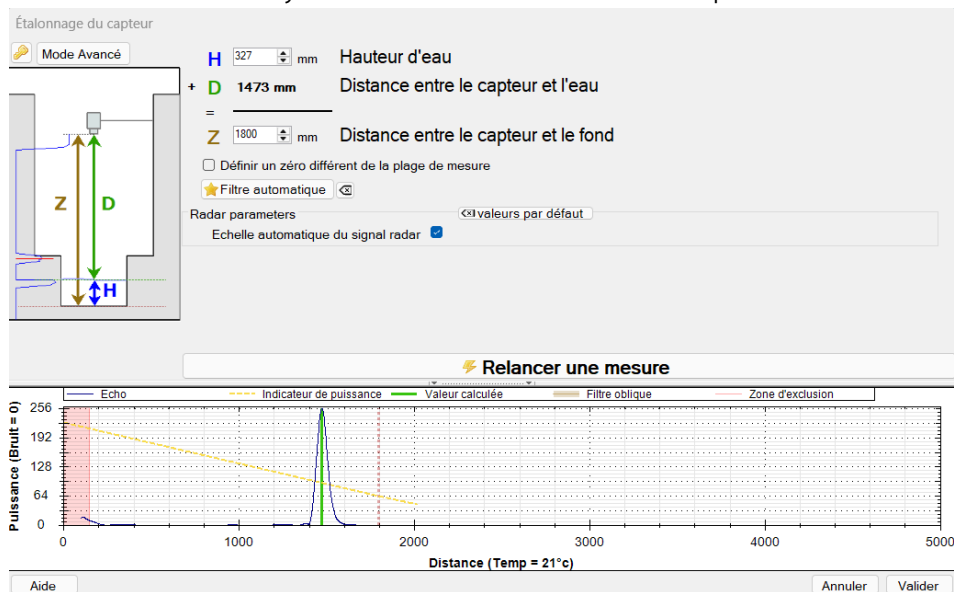

- Enter the distance between the sensor and the bottom and click on "Launch a new measure" to save the configuration changes on the sensor and view the result.

Echo graph

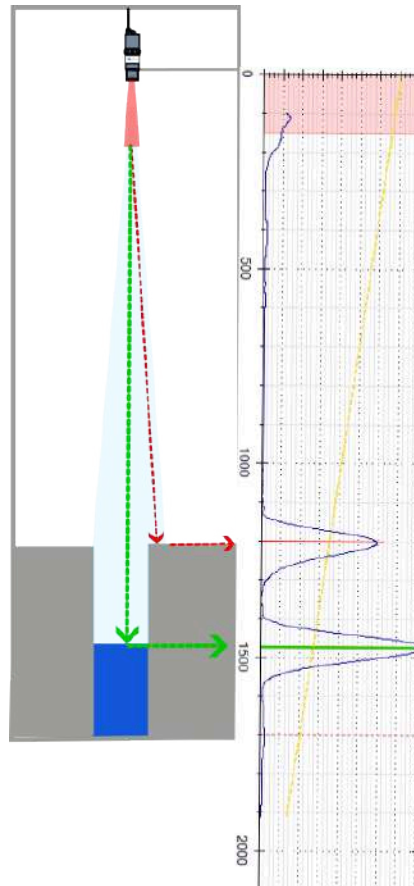

The graph displayed shows the echo of the radar wave returned:

- The peaks indicate where the sensor "detects" an obstacle.
- Red lines indicate whether obstacles are detected that could interfere with the measurement.
- The dotted red line indicates the Z configured.
- The shape at the start of the echo corresponds to the "blind" zone for the sensor, in which no measurements can be taken.
- The red zone corresponds to the sensor's blind zone filter, the brown zone to the oblique filter. These filters are defined in advanced mode.
- The green line indicates the obstacle which is considered the correct measurement by the sensor.
- The yellow line indicates the recommended level of measurement: The peak representing the correct measurement should be near this line.
- The advanced mode button provides additional echo filtering functions. The key button gives access to the expert settings.



You can zoom in on the graph using the mouse wheel.

- To restore the initial display, double-click on the graph.

Define a zero outside the measurement range

It is possible to define a "zero" level other than the culvert, particularly useful for storm overflows, for example, where it is possible to set the zero at the level of the overflow weir.

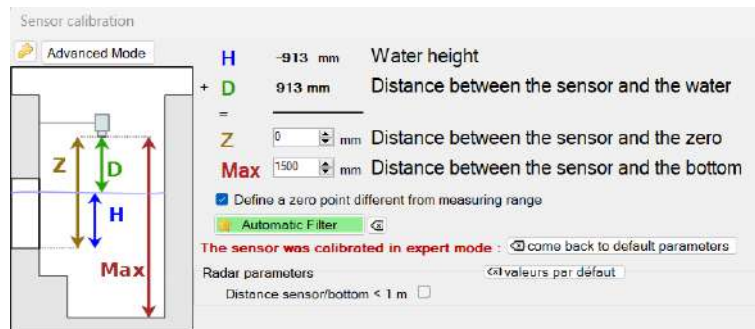

Advanced mode

Click on "Advanced mode" to display measurement and computation parameters.

Measurement parameters

Gain: Adjust the amplification when receiving the radar wave.

Number of integrations: Number of successive echoes emitted.

Type of integration: Echo processing, the "minimum", an "average" or the "maximum".

Computation parameters

Exclusion zone: Value in mm of the sensor blind zone.

Filter y-axis: Adjust the power of the filter.

Filter coefficient: Adjust the slope of the filter.

Radar settings

Automatic signal scale: Automatic adjustment of the radar signal display to full scale

Offset: Adjustment of the measured distance D to reach the actual distance.

Critical Obstacle echo processing: Apply an oblique filter

In case of a message: **ATTENTION! : Potential obstacle(s) detected**, insofar as possible you must modify the positioning of the sensor to correct the problem (see [Positioning a radar sensor](#)).

In the example below, a critical obstacle is detected (in red). It corresponds to a fixed obstacle near the sensor.

- Before applying a filter, check whether the positioning can be modified to obtain a cleaner measurement.

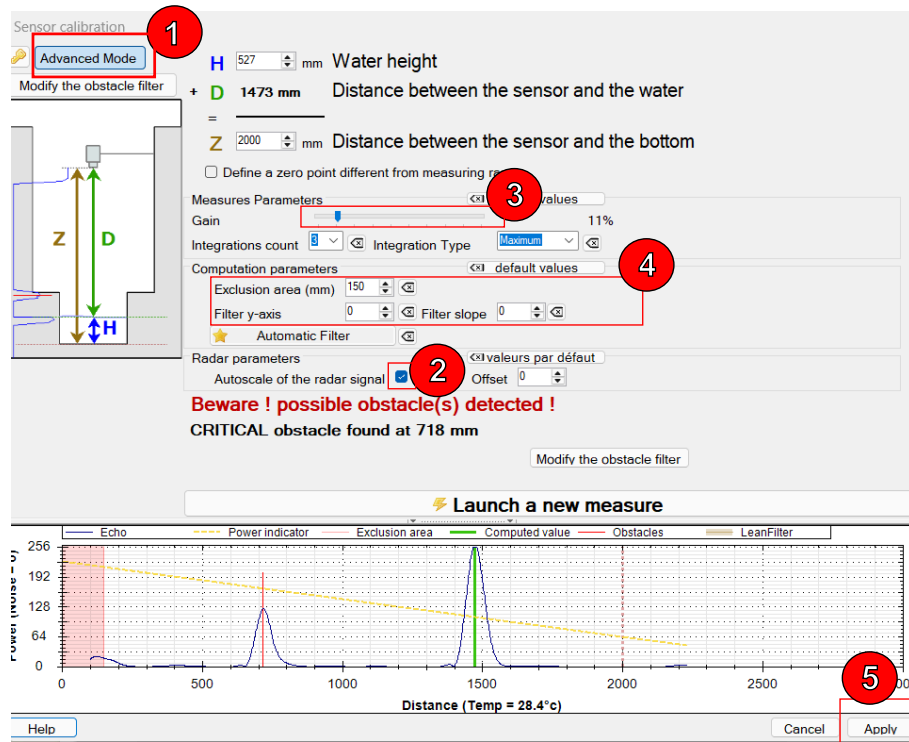

This echo can be processed using an oblique filter that can be configured as follows:

- Click on the “Advanced mode” button to display the processing parameters (1).
- Uncheck (2) the radar parameter: **Autoscale of the radar signal**.

In this case, automatic display processing must remain inactive to prevent it from further amplifying the amplitude of the echo of the obstacle, which must remain constant regardless of the amplitude of the peak returned by the echo of the water (distance D in green).

- Adjust the **gain** (3) so that the amplitude of the green peak is slightly above the power indicator (yellow line) and redo the measurement to refine the settings until you get a result as shown below.

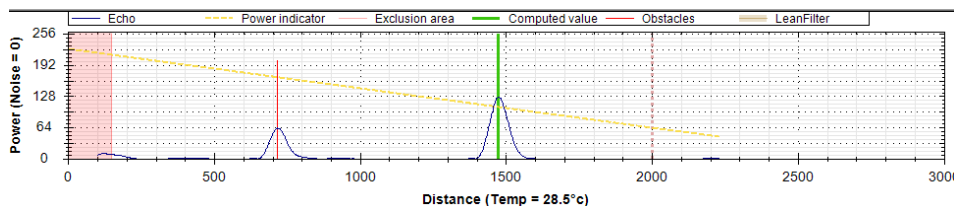

- Adjust the filter settings (4) to obtain a result similar to the example below.
 - Define filter power: **Filter y-axis**, equal to 220 in the case above.
 - Define its slope: **Filter slopet**, equal to 34 in the case above.

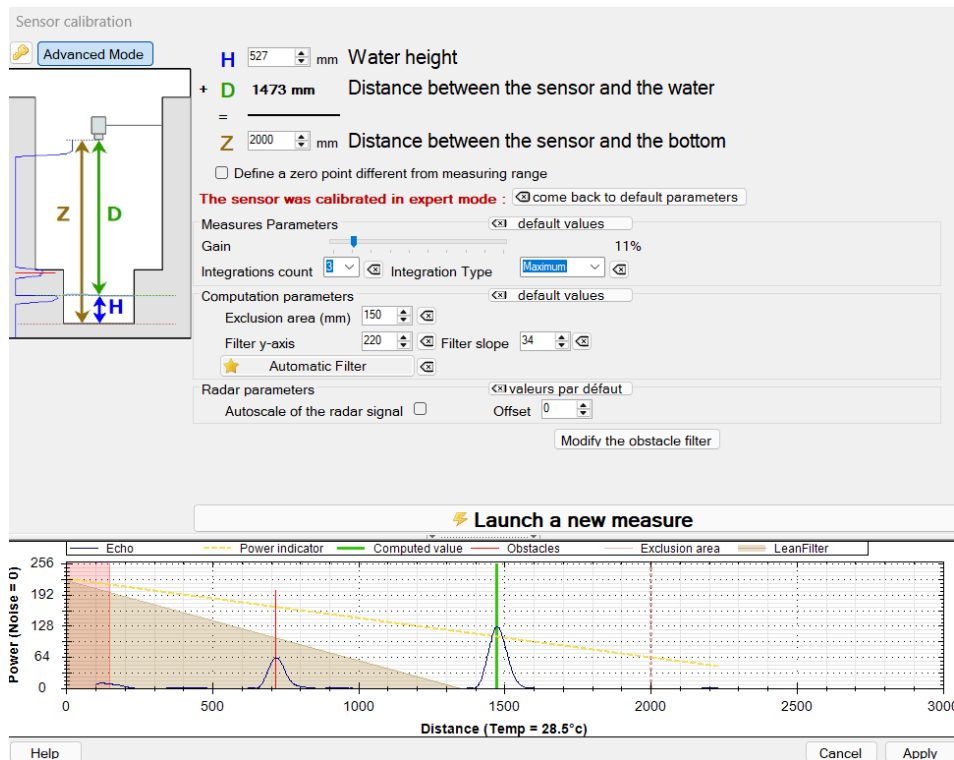

- Click on “Validate” (5) to apply the processing.

Critical obstacle echo processing: Apply an obstacle filter

In case of a message: **ATTENTION! : Potential obstacle(s) detected**, insofar as possible you must modify the positioning of the sensor to correct the problem (see [Positioning a radar sensor](#)).

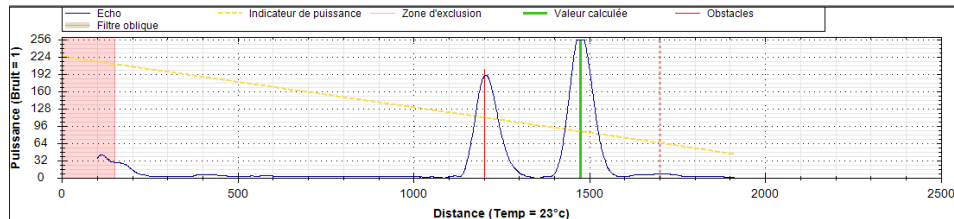

- Before applying a filter, check whether the positioning can be modified to obtain a cleaner measurement.

If this is not possible, and if the oblique filter is not applicable in the case where the obstacle is too close to the water, then you must create an “obstacle filter” which consists in masking the obstacles that interfere with the measurement such as fixed obstacles such as culverts or any other bars in the cone of the radar beam.

- Click on the “Advanced mode” button to display the processing parameters (1).
- Uncheck (2) the radar parameter: **Automatic signal scale**.

In this case, automatic display processing must remain inactive to prevent it from further amplifying the amplitude of the echo of the obstacle, which must remain constant regardless of the amplitude of the peak returned by the echo of the water (distance D in green).

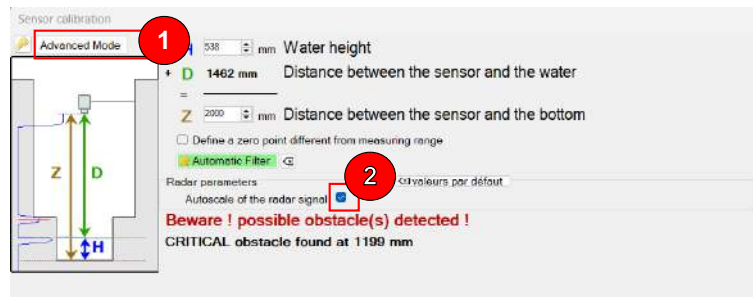

- Adjust the **gain** (3) so that the amplitude of the green echo is slightly above the power indicator (yellow line) and redo the measurement to refine the settings until you get a result as shown below.

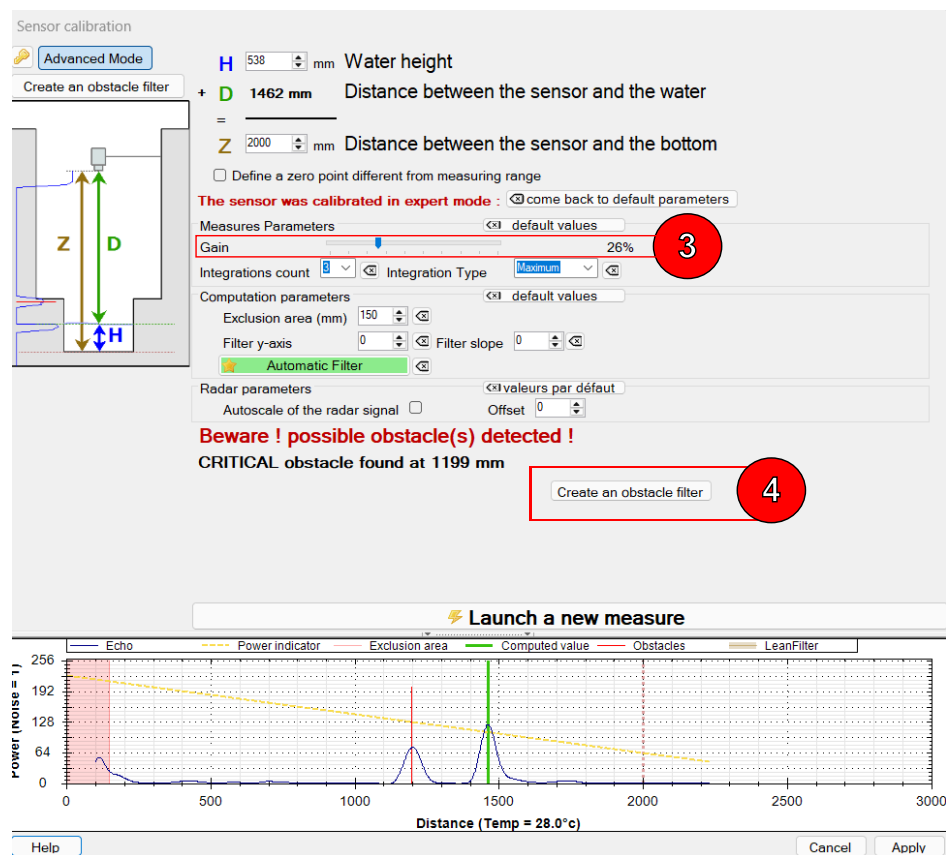

- Click on **Create an obstacle filter** (4).
- Select the echo of the obstacle to be filtered for the **obstacle** check box (5) and the echo of the distance measure D for the **measurement** check box (6).
- Click on "Create filter" (7).

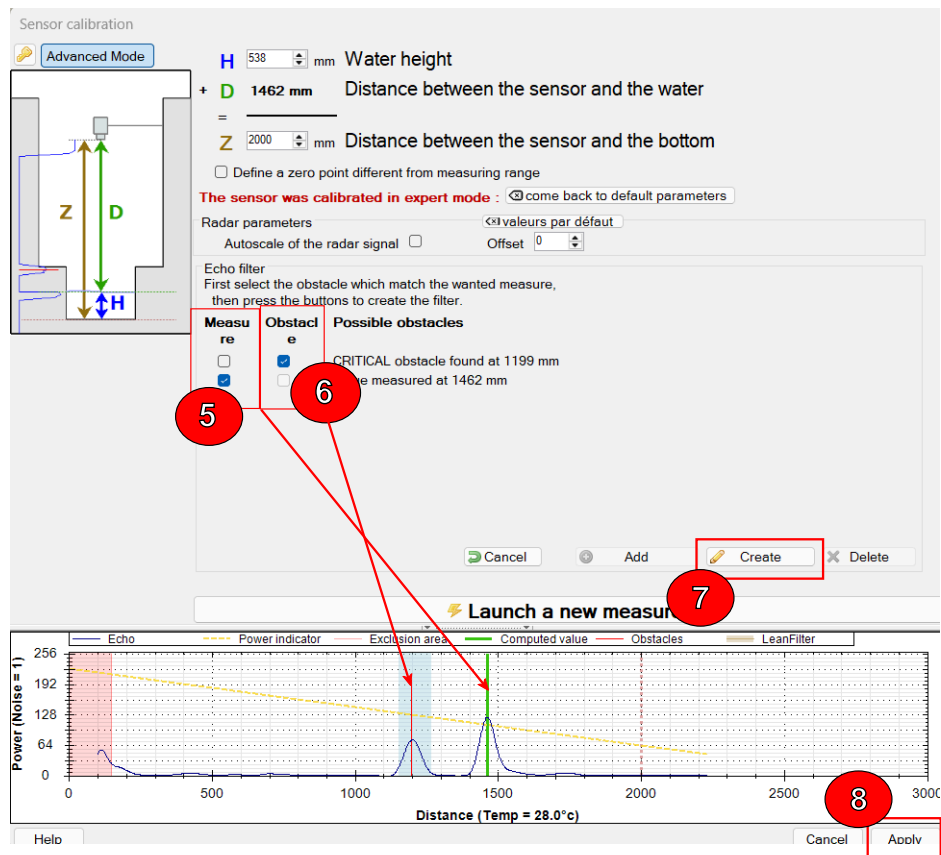

- Click on Validate (8) to apply the processing.

-> The obstacle echo is masked by a filter and appears in red on the graph.

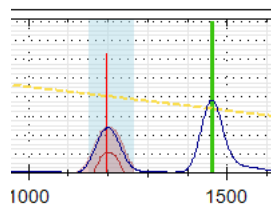



Filtered obstacle

Complex cases: expert mode

Expert mode is reserved for delicate cases requiring a certain level of expertise in data processing using ultrasonic or radar measurement. Numerous parameters are available. This activity is not detailed in this documentation. **Switching to expert mode is password-protected. Contact your correspondent or Ijinus if you need to use this expert mode, and we'll provide you with the password and explanations.**

Record distance between sensor and water (Advanced parameter)

Click on  to display and activate  if necessary, record the distance **D** between the sensor and the water for each measurement.

Debugging echoes (Advanced settings)

Debugging echoes are recorded when there are differences between two successive level measurements (on rise and/or descent: here 75 mm for both), the acoustic signature of the measurements, or radar echoes (already detailed above). A posteriori examination will then enable us to diagnose the quality of level measurements and correct calibration to obtain more easily usable measurements. For first-time installations, or in the case of delicate points, we strongly advise you to activate this function.

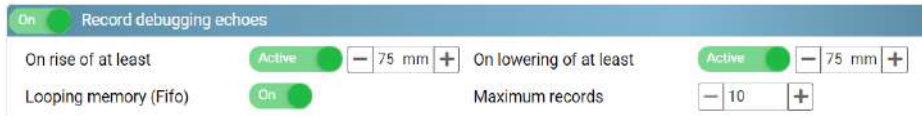

Height value for loss of echo (Advanced settings)

In the field of radar, echo loss means the absence of a peak (or a peak so weak that it is not detected as an obstacle) on the echoes, which is materialized by a maximum height, i.e. equal to the Z entered during calibration. When the sensor encounters this situation, this function replaces the erroneous "a priori" value with a value of the user's choice: last valid value, value to be defined, etc.

Although this function can be useful, it must be used judiciously and should not be used to compensate for unsuitable calibration.



Volume

Cumulated volume : Hourly, daily or monthly

Record infinite accumulation  : Enables cumulative volume recording indefinitely



Radar Raven eye





In Fuzion software :

- Set the unit settings for the device: velocity must be in **m/s** and flow rates in **m³/s**.
 - For the Raven Eye to measure correctly, its '**Median Filter for Level**' setting must be set to **0**.
 - Velocity choice : **vAGV**.
-
- Activate  the measurement above a height threshold measured by the radar.



Paramètres du radar RAVEN EYE

- Click on  to display the pre-feed time setting.
- Click on  Diagnostic to display values.



If the sensor cannot provide a measurement, positive values between 99, 255, or 9999 are suggested.

Type of data recorded / broadcast

Data type	DataID	Default value	Data recording options				Data broadcast in RF
			Normal mode	Record diagnostic data	Advanced Mode: Record extended diagnostic data	Expert Mode: Record advanced diagnostic data	
Raw surface velocity (Vraw) in mm/s	24[2]	9999			YES	YES	YES
Surface velocity including quality factors (Vqp) in mm/s	24[1]	9999			YES	YES	YES
Average velocity (Vavg) in mm/s	24[0]	9999	YES		YES	YES	YES
Height (height transmitted by the LNU and used for velocity calculation), in m	14[1]	999				YES	YES

Flow in m3/s	34[0]	999	YES		YES	YES	
Standard deviation without unit	21[0]	999				YES	
SNR without unit	25[2]	255		YES	YES	YES	YES
Amplitude in dB	21[3]	999			YES	YES	
VSN without unit	25[1]	255		YES	YES	YES	YES
AGC in dB	21[1]	999			YES	YES	
NOT without unit	21[2]	999			YES	YES	
Status (can be used for diagnostic) in DEC	21[5]	999				YES	
Temperature in °C	12[1]	99			YES	YES	
Humidity in %	21[4]	999				YES	
Pressure in bar	37[0]	999				YES	

Force a measurement



Set the measurement period to "Stop"

- Click on the "Test measure" button.

-> After approx. 40 seconds, the following screen appears:



- The velocity after taking quality parameters into account is a surface velocity for which the parameters entered in Fuzion are used.
- Average velocity is calculated from height, cross-section and velocity values above (and, depending on the version, after application of computation filters).
- VSN and SNR are two of the most important quality parameters,

In the event of values that do not correspond to reality or to default values, check that the LNU was in Stop mode if using Force Measurement and under Fuzion for the rest.

Configuration summary

To view the configuration summary:

- Click on [SEE OVERVIEW](#) to display a summary of the configuration.



Mapping table between DataID, channel & data

DataId	Channel	Data displayed	Units	Data Description	Data files
3	7	Debug (signed integer value)	mAh	Internal battery current consumption	*_diag.bin
6	0	Voltage	V	Instantaneous internal battery voltage (Res. 0.05 V)	*_diag.bin
6	1	Voltage	V	Minimum internal battery voltage reached (Res. 0.05 V)	*_diag.bin
12	0	Measure temperature	°C	Sensor temperature measurement (Res. 0.1°C)	*_radar.bin
15	0	Material height	mm	Water Height	*_radar.bin
17	0	GSM signal Power	dBm	GSM signal power	*_diag.bin
19	0	Date	-	POSIX time	Asynchronous data
20	0-7	Overflow	-	Overflow status	*_ovsoft.bin
36	0	Distance	mm	Sensor-Water distance	*_radar.bin
44	2	Angle	°	Roll angle (Res. 0.1°)	*_angle.bin
44	3	Angle	°	Longitudinal axis angle (Res. 0.1°)	*_angle.bin

9.6.6. Radar Water height + wired overflow detector

Water level measurement configuration



Prerequisites: In Avelour, the Wiji connection to the logger must be established, see [Connecting to a logger](#).

- Click on  to add a measurement configuration and select "Radar water level + external velocity -> Flow".

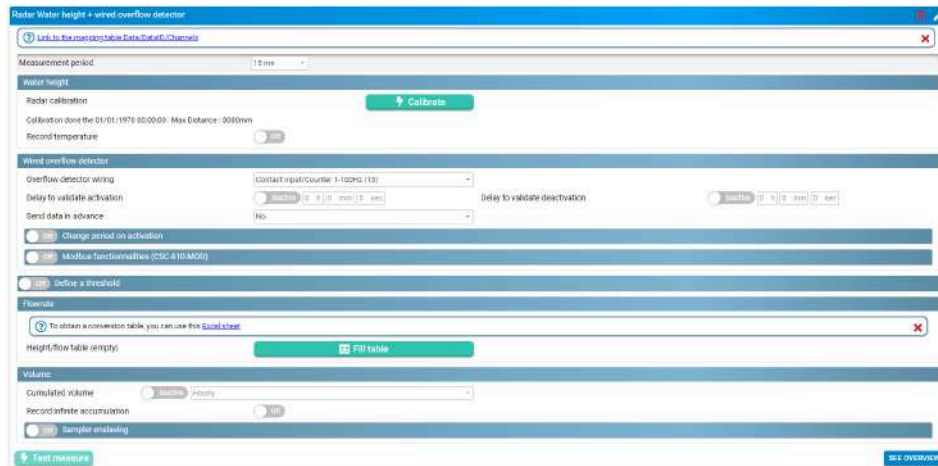

Measure period

- Select a period between each measurement from the list. In the example above, a measurement will be taken every 15 minutes.

Radar calibration



For distance measurements of more than 6 metres, version 7.2 of Avelour is required and the firmware installed must at least version 23.5 (refer to paragraph [Firmware update](#)).



Prerequisites: In Avelour, the Wiji connection to the logger must be established, see [Connecting to a logger](#).



Before calibration, make sure the radar sensor is correctly positioned (see paragraph [Positioning a radar sensor](#)).

- Click on  to start radar sensor calibration.

-> A distance measurement is automatically started and the calibration window opens.

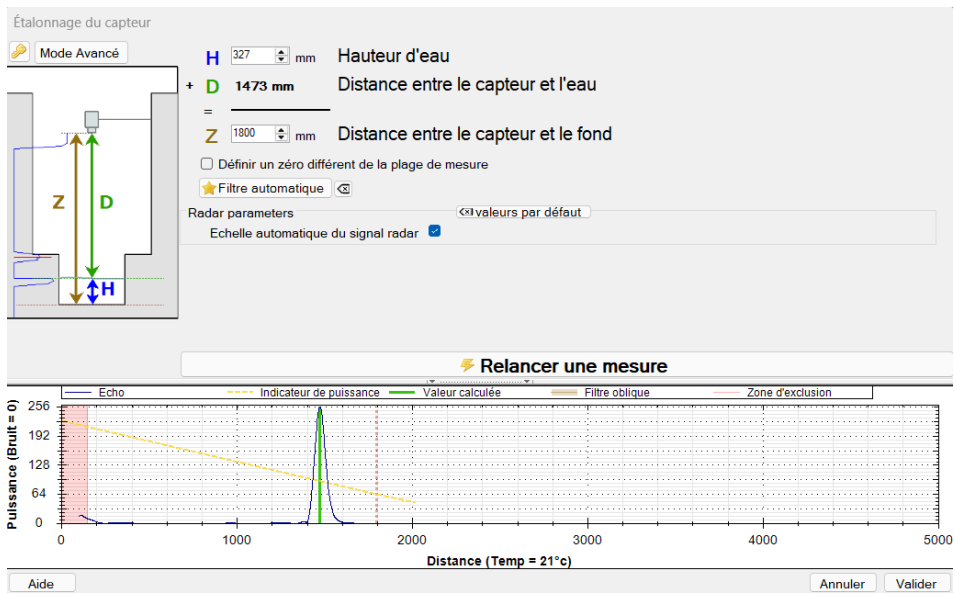

- Enter the distance between the sensor and the bottom and click on "Launch a new measure" to save the configuration changes on the sensor and view the result.

Echo graph

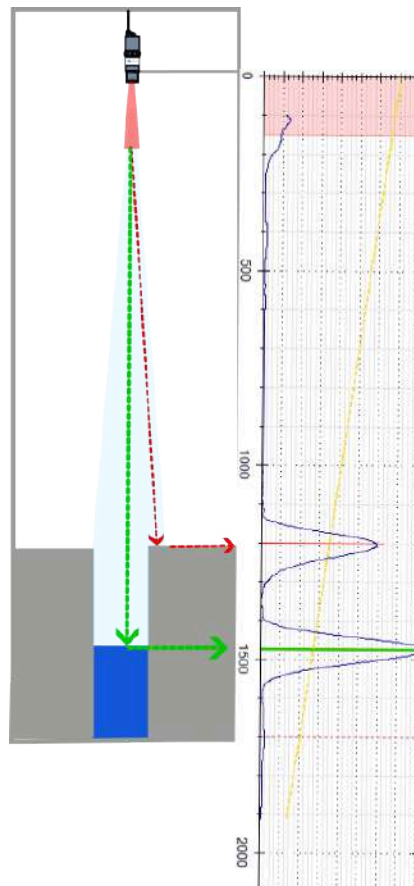

The graph displayed shows the echo of the radar wave returned:

- The peaks indicate where the sensor "detects" an obstacle.
- Red lines indicate whether obstacles are detected that could interfere with the measurement.
- The dotted red line indicates the Z configured.
- The shape at the start of the echo corresponds to the "blind" zone for the sensor, in which no measurements can be taken.
- The red zone corresponds to the sensor's blind zone filter, the brown zone to the oblique filter. These filters are defined in advanced mode.
- The green line indicates the obstacle which is considered the correct measurement by the sensor.
- The yellow line indicates the recommended level of measurement: The peak representing the correct measurement should be near this line.
- The advanced mode button provides additional echo filtering functions. The key button gives access to the expert settings.



You can zoom in on the graph using the mouse wheel.

- To restore the initial display, double-click on the graph.

Define a zero outside the measurement range

It is possible to define a "zero" level other than the culvert, particularly useful for storm overflows, for example, where it is possible to set the zero at the level of the overflow weir.

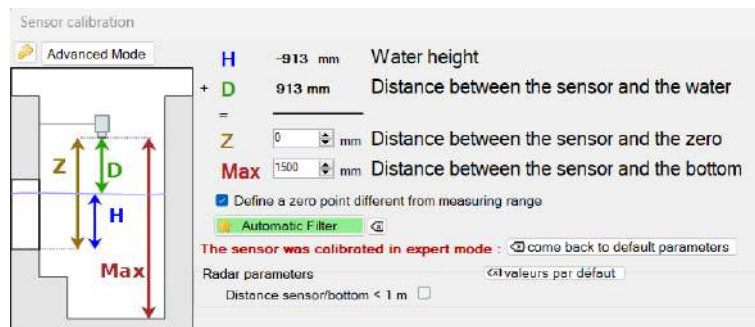

Advanced mode

Click on "Advanced mode" to display measurement and computation parameters.

Measurement parameters

Gain: Adjust the amplification when receiving the radar wave.

Number of integrations: Number of successive echoes emitted.

Type of integration: Echo processing, the "minimum", an "average" or the "maximum".

Computation parameters

Exclusion zone: Value in mm of the sensor blind zone.

Filter y-axis: Adjust the power of the filter.

Filter coefficient: Adjust the slope of the filter.

Radar settings

Automatic signal scale: Automatic adjustment of the radar signal display to full scale

Offset: Adjustment of the measured distance D to reach the actual distance.

Critical Obstacle echo processing: Apply an oblique filter

In case of a message: **ATTENTION! : Potential obstacle(s) detected**, insofar as possible you must modify the positioning of the sensor to correct the problem (see [Positioning a radar sensor](#)).

In the example below, a critical obstacle is detected (in red). It corresponds to a fixed obstacle near the sensor.

- Before applying a filter, check whether the positioning can be modified to obtain a cleaner measurement.

This echo can be processed using an oblique filter that can be configured as follows:

- Click on the “Advanced mode” button to display the processing parameters (1).
- Uncheck (2) the radar parameter: **Autoscale of the radar signal**.

In this case, automatic display processing must remain inactive to prevent it from further amplifying the amplitude of the echo of the obstacle, which must remain constant regardless of the amplitude of the peak returned by the echo of the water (distance D in green).

- Adjust the **gain** (3) so that the amplitude of the green peak is slightly above the power indicator (yellow line) and redo the measurement to refine the settings until you get a result as shown below.

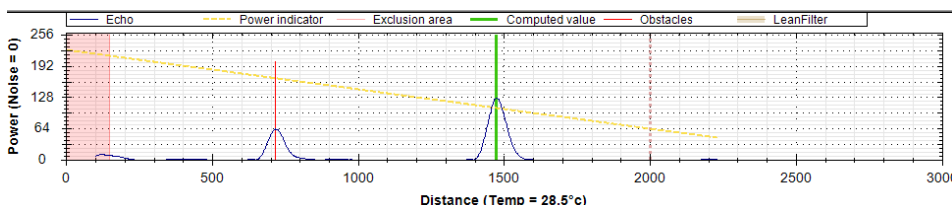

- Adjust the filter settings (4) to obtain a result similar to the example below.

- Define filter power: **Filter y-axis**, equal to 220 in the case above.
- Define its slope: **Filter slopet**, equal to 34 in the case above.

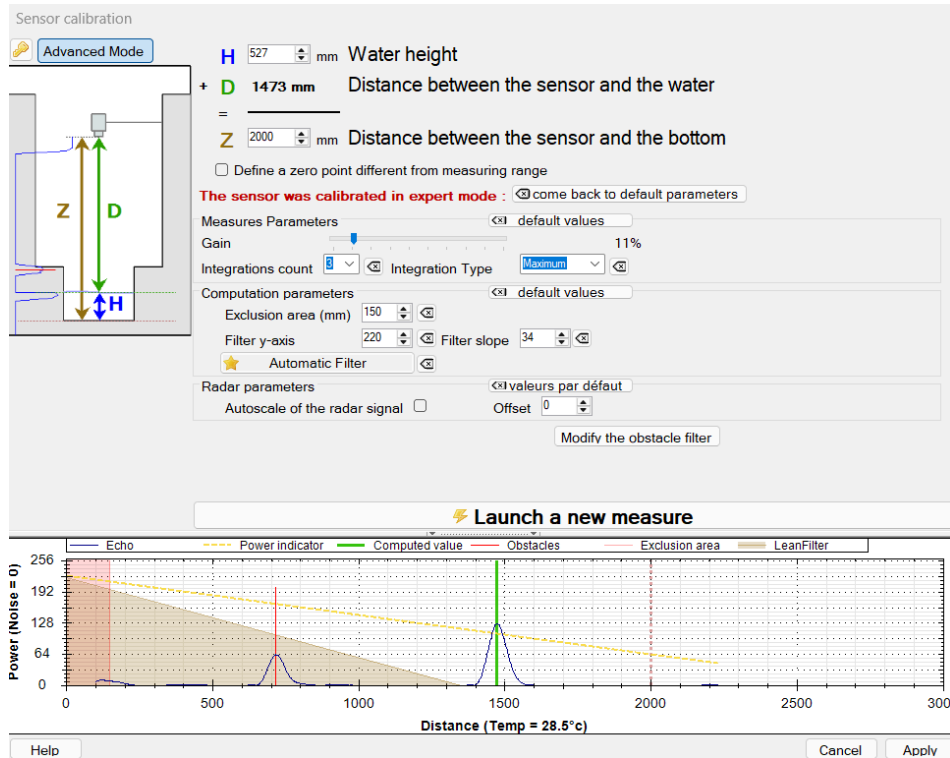

- Click on “Validate” (5) to apply the processing.

Critical obstacle echo processing: Apply an obstacle filter

In case of a message: **ATTENTION! : Potential obstacle(s) detected**, insofar as possible you must modify the positioning of the sensor to correct the problem (see [Positioning a radar sensor](#)).

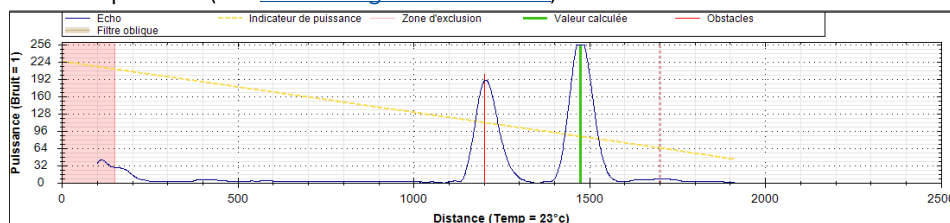

- Before applying a filter, check whether the positioning can be modified to obtain a cleaner measurement.

If this is not possible, and if the oblique filter is not applicable in the case where the obstacle is too close to the water, then you must create an “obstacle filter” which consists in masking the obstacles that interfere with the measurement such as fixed obstacles such as culverts or any other bars in the cone of the radar beam.

- Click on the “Advanced mode” button to display the processing parameters (1).
- Uncheck (2) the radar parameter: **Automatic signal scale**.

In this case, automatic display processing must remain inactive to prevent it from further amplifying the amplitude of the echo of the obstacle, which must remain constant regardless of the amplitude of the peak returned by the echo of the water (distance D in green).

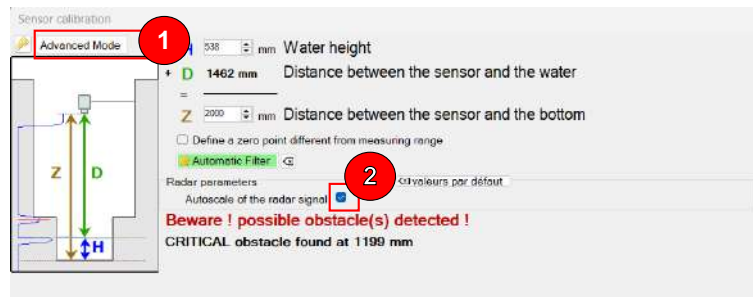

- Adjust the **gain** (3) so that the amplitude of the green echo is slightly above the power indicator (yellow line) and redo the measurement to refine the settings until you get a result as shown below.

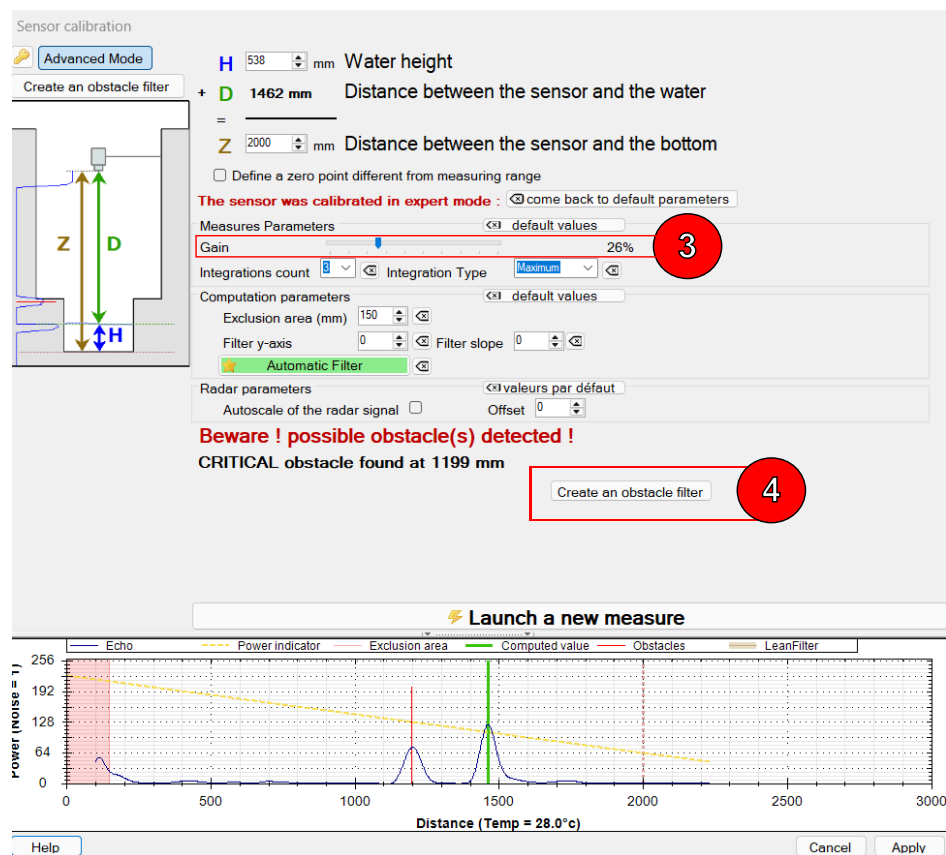

- Click on **Create an obstacle filter** (4).
- Select the echo of the obstacle to be filtered for the **obstacle** check box (5) and the echo of the distance measure D for the **measurement** check box (6).
- Click on “Create filter” (7).

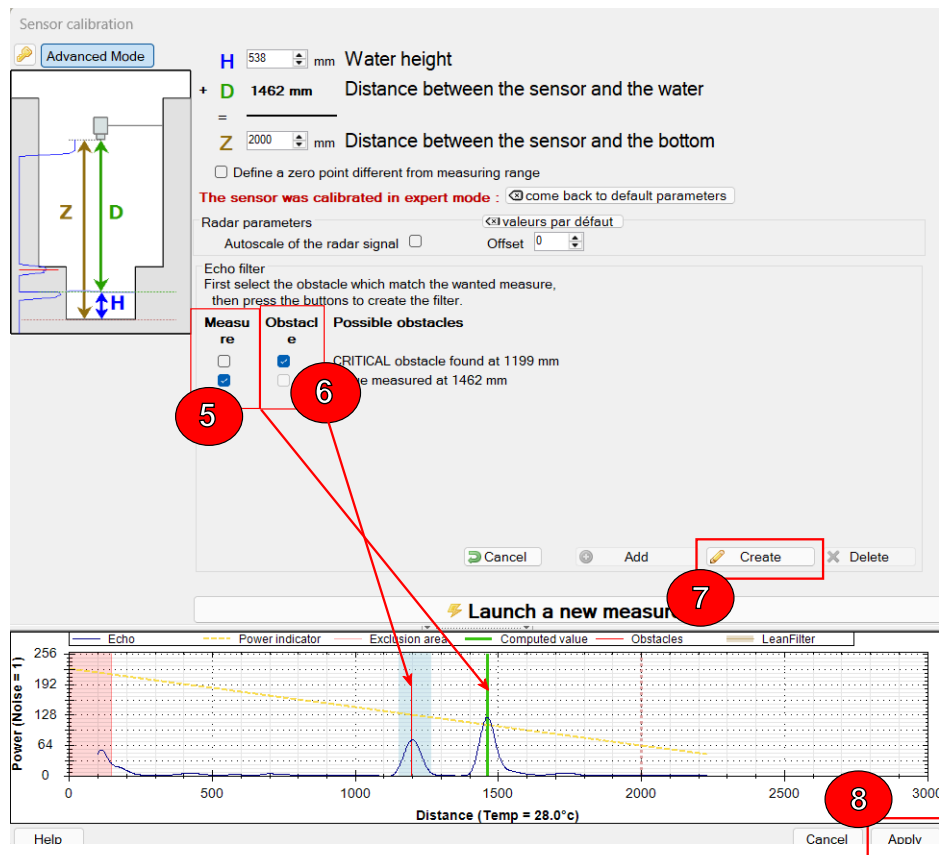

- Click on Validate (8) to apply the processing.

-> The obstacle echo is masked by a filter and appears in red on the graph.

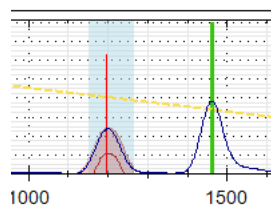

Filtered obstacle

Complex cases: expert mode

Expert mode is reserved for delicate cases requiring a certain level of expertise in data processing using ultrasonic or radar measurement. Numerous parameters are available. This activity is not detailed in this documentation. **Switching to expert mode is password-protected. Contact your correspondent or Ijinus if you need to use this expert mode, and we'll provide you with the password and explanations.**

Modifying the frequency of measurements on a measurement threshold

- Activate if necessary, **change period on height threshold** to display the following configuration parameters:

Changed period: New frequency of threshold measurements. **Direction:** Threshold on a high or low level.

Height: Threshold to be reached to activate modification. **Hysteresis:** Value to be subtracted (high level) or added (low level) to the threshold at which the measurement frequency returns to its initial value.

Minimum time before deceleration: Hold time for the new measurement frequency before returning to its initial value.

Example below: Measure period is reduced from 5 minutes to 10 seconds when the water level exceeds 1000 mm. When the water level falls below 800 mm for 1 minute, the measure period remains at 10 seconds, then returns to 5 minutes.

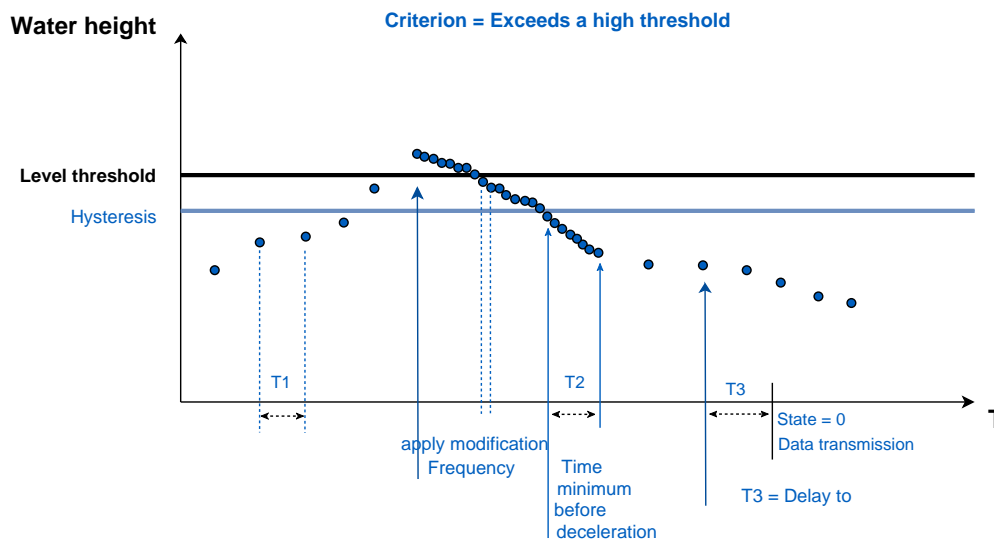

Defining an overflow threshold

A change in measure period can be activated using a high or low level threshold .

Height : Level threshold at which overflow status changes to 1. **Hysteresis:** Value to be subtracted from the threshold at which the overflow state returns to 0.

Delay to validate activation: Determines the time after which the overflow state changes to 1, once the threshold has been exceeded. **Delay to validate deactivation:** Time after which overflow status changes to 0.

Anticipate data sending: Data transmission can be forced on activation of overflow status, deactivation of overflow status or both. **Repeat data sending every:** If data transmission on activation is selected, this enables you to modify the data transmission period.



If anticipate data sending is enabled, then when the threshold is reached, an alert SMS is sent to an operator if the option is enabled (see [Sending an alert SMS](#)).

Example: If the height level exceeds 1000 mm for 1 minute, the overflow status changes to 1, and data are sent once, then a second time 10 minutes later. If the measured height falls below the 900 mm threshold for 1 minute, the overflow status returns to 0.

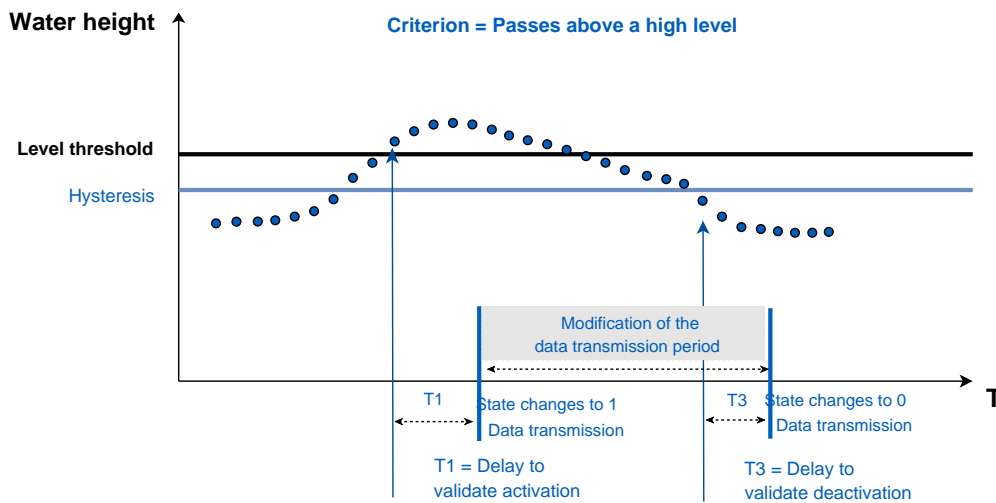

Record soft overflows

Fifo Memory (Advanced Setting)

By default, when the logger memory is full, data are deleted in chronological order of recording, from oldest to newest.

- Click  to display advanced settings.
- If Fifo memory is disabled, change the maximum number of timestamps for the main memory (used for sending data via Internet) and the auxiliary memory (used for sending data via SMS) if necessary.

Maximum records SMS Maximum records

Define a second threshold

On Define a second threshold

Direction:

Height: mm

Hysteresis: mm

Delay to validate activation: Inactive h min sec

Delay to validate deactivation: Inactive h min sec

Anticipate data sending: Repeat data sending every: Inactive h min sec

Direction: Defines whether the measured level threshold passes **above a high level** or **below a low level**.

Height: Height threshold.

Hysteresis: Value to be subtracted from (if high level) or added to (if low level) the threshold.

Delay to validate activation: Time after which the threshold is reached.

Delay to validate deactivation: Time after which the threshold is no longer reached.

Anticipate data sending: Data transmission can be forced on activation, deactivation or both.

Repeat data sending every: If data transmission on activation is selected, this enables you to modify the data transmission period.



If anticipate data sending is enabled, then when the threshold is reached, an alert SMS is sent to an operator if the option is enabled (see [Sending an alert SMS](#)).

Wired overflow detector

Configuration

Activation / deactivation processing time : A time delay can be set for activation and deactivation of the overflow state.

Anticipate data transmission: Data transmission can be forced to activation, deactivation or both overflow states.

Repeat transmission : Activates modification of the data transmission cycle.

Cumulate the time spent in overflow all the: Define a recording frequency for cumulative time spent in overflow.

Modbus functionalities (CSC-810-MOD)

Read the configured detection threshold: Click  to display the threshold set on the detector.

CSC slave address  select the expected channel as configured in Modbus master.

Modify the detection threshold

Desired detection threshold: define the percentage of the capacitive saturation detection threshold.



A 5% hysteresis is set on the capacitive saturation value threshold before state change. This means that for a value set at 80%, the overflow state will no longer be active as soon as the value falls below 75%.

- Click  **Run** so that the updated detection threshold is taken into account on the detector.

Configuration summary

To view the configuration summary:

- Click  to display a summary of the configuration.

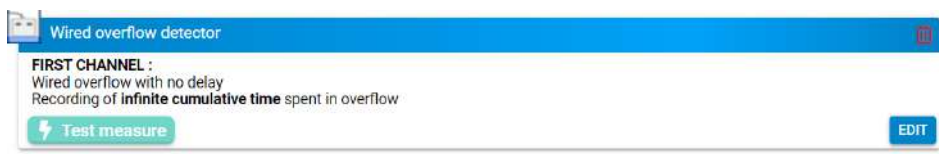



Table of correspondences (Data ID / Channel / files)

DataId	Channel	Data displayed	Units	Data Description	Data files
6	0	Voltage	V	Instantaneous internal battery voltage (Res. 0.05 V)	*_diag.bin

DataId	Channel	Data displayed	Units	Data Description	Data files
6	1	Voltage	V	Minimum internal battery voltage reached (Res. 0.05 V)	*_diag.bin
7	0	Voltage	V	Instantaneous internal overflow battery voltage (Res. 0.01 V) - Channel 1	*_diagOv.bin
7	1	Voltage	V	Instantaneous internal overflow battery voltage (Res. 0.01 V) - Channel 2	*_diagOv.bin
11	0	System temperature	°C	System temperature of the overflow device - Channel 1	*_mbCap.bin
11	1	System temperature	°C	System temperature of the overflow device - Channel 2	*_mbCap2.bin
17	0	GSM signal Power	dBm	GSM signal power	*_diag.bin
19	0	Date	-	POSIX time	Asynchronous data
20	0	Overflow	-	Overflow status - Channel 1	*_ovhard.bin
20	1	Overflow	-	Overflow status - Channel 2	*_ovhard2.bin
23	0	Capacitive saturation	%	Capacitive saturation of the overflow device - Channel 1	*_mbCap.bin
23	1	Capacitive saturation	%	Capacitive saturation of the overflow device - Channel 2	*_mbCap2.bin
40	0	Duration	s	Cumulated time spent in overflow on defined period - Channel 1	*_ovhReport.bin
40	1	Duration	s	Infinite cumulated time spent in overflow - Channel 1	*_ovhard.bin
40	2	Duration	s	Cumulated time spent in overflow on defined period - Channel 2	*_ovhReport2.bin
40	3	Duration	s	Infinite cumulated time spent in overflow - Channel 2	*_ovhard2.bin

Flow

The calculation is possible, but the validity of the calculation depends on the quality of the height/flow relationship.

- To calculate the flow rate, please refer to the excel form available via the link on Avelour.
- Fill in the height/surface table by clicking on .

Flowrate

Height/surface table (empty)

 Fill table

Volume



Cumulated volume Record cumulative volume on an hourly, daily or monthly basis.

Record infinite accumulation Activates cumulative volume recording indefinitely.

Sampler enslaving

It is possible to control a sampler using the **open-drain output** or the **direct external power supply output Vout** of the logger. In the example below, the logger sends a pulse to the sampler each time a volume of 1 cubic meter is calculated.

- Test the slaving by clicking on  which forces a pulse to be sent.

Configuration summary

To view the configuration summary:

- Click on [SEE OVERVIEW](#) to display a summary of the configuration.

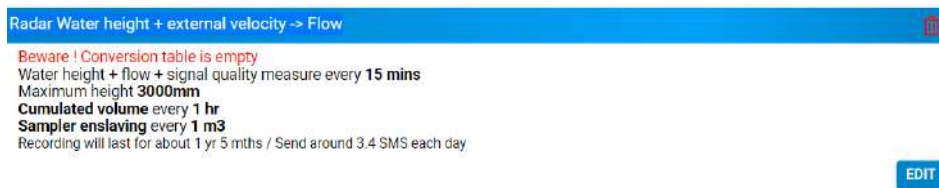

Mapping table between DataID, channel & data

DataId	Channel	Data displayed	Units	Data Description	Data files
3	7	Debug (signed integer value)	mAh	Internal battery current consumption	*_diag.bin
6	0	Voltage	V	Instantaneous internal battery voltage (Res. 0.05 V)	*_diag.bin
6	1	Voltage	V	Minimum internal battery voltage reached (Res. 0.05 V)	*_diag.bin
12	0	Measure temperature	°C	Sensor temperature measurement (Res. 0.1°C)	*_radflow.bin
15	0	Material height	mm	Water Height	*_radflow.bin
17	0	GSM signal Power	dBm	GSM signal power	*_diag.bin
19	0	Date	-	POSIX time	Asynchronous data
24	0	Velocity	mm/s	Flow velocity	*_radflow.bin
25	0	Doppler signal quality	%	Doppler signal quality	*_radflow.bin

DataId	Channel	Data displayed	Units	Data Description	Data files
34	0	Flow	m ³ /s	Water flow	*_radflow.bin
36	0	Distance	mm	Sensor-Water distance	*_radflow.bin
39	0	Volume	m ³	Cumulated volume	*_volcount.bin
39	1	Volume	m ³	Infinite volume	*_radflow.bin
44	2	Angle	°	Roll angle (Res. 0.1°)	*_angle.bin
44	3	Angle	°	Longitudinal axis angle (Res. 0.1°)	*_angle.bin

9.6.7. Intelligent low-power Doppler measurement (Ubertone sensor)

Principle

The Ubertone sensor is a Doppler-effect velocity sensor. Placed in the opposite direction to the flow, its principle is to measure the velocities of bubbles and/or particles present in the water, assuming that they are moving at the same speed as the water. Ubertone technology measures the velocity of bubbles and/or particles in a 65° emission cone (relative to the horizontal), with a propagation angle of 10°. In less than a second, the sensor fires more than 1,000 ultrasonic beams at a frequency of 1 MHz.

The Doppler velocity sensor can be connected to an energy pack, which in turn is connected to the water level sensor, or powered directly by the internal battery. The height sensor needs to be configured, as it controls velocity measurement, height measurement, a number of calculations and data transmission.

Configuration

- Click  to add a measurement configuration and select "Intelligent low-power Doppler measurement".
- Select a measure period identical to that set for level measurement.

Ubertone Doppler 🗑️ ⚙️

?





[Usage and parameters documentation](#) ✖

Measure period

Record base diagnostic data Off

[Go to power configuration menu](#)

No external power

 Force a measure
 Diagnostic

 Test measure
VIEW RESUME

Operation in default configuration

In simple mode (default setting), the doppler is configured as follows:

- Whatever the threshold of usable echo quantity (Doppler quality channel 1), the sensor will propose a velocity value.
- For each velocity measurement, a global quality code (Doppler channel 0) is calculated, ranging from 0 to 4:
 - 4: best quality.
 - 2 or 3: the average value from the sensor (Channel 1) is not representative of the actual flow velocity. This configuration is most often encountered when the water level is low: less than 5 cm, i.e. less than 2 to 3 cm above

the sensor. In this case, since the average velocity (1) of the sensor is not representative, the Hydraulic indicator (noted at 3, i.e. $V_{\text{average}} / V_{\text{max}}$) cannot be used for typical values either.

- 0: sensor does not respond.

If the mean velocity (channel 0) is greater than 200 mm/s and the ratio between the standard deviation (channel 2) and its mean velocity is less than 0.25 (i.e. less than 25% variation), then the proposed velocity (i.e. channel 0 - the one used to calculate flow in the LNU) will be the mean velocity obtained from the sensor, and the sensor's overall quality code (Doppler quality channel (0)) will be equal to 4.

If the quality code is less than 4 (in this case 3 or 2), then the velocity (proposed in channel 0) will be derived from the maximum sensor velocity (channel 3) multiplied by 0.8 (multiplying factor).

Measure check

- Click  to view Ubertone sensor measurement results.

If the sensor cannot provide a reliable measurement, then Measurement quality = 1 and Velocity after processing = -9999 mm/s (default replacement value).

If the sensor does not respond, then Measurement quality=0 and Velocity= +9999 mm/s.



Typical values may differ from site to site. The two most important indicators are:

- global (4 = best, 1 = worst),
- Doppler SNR (20 = best, <10 poor).

The hydraulic indicator should only be interpreted if the global quality code is 4.

Channel	Measurement quality (0-4)	Typical values
Channel 1	EchoSnr: exploitable echo quantity - Water bubble/particle indicator (0-40 dB)	<ul style="list-style-type: none"> • 0 to 3 in air • 3 to 10 between air & water • from 10 to 40 in water (40 being strictly wastewater or multiple)
Channel 2	DopplerSnr: Doppler evaluation quality (0-20 dB)	<ul style="list-style-type: none"> • below 10: mediocre • from 10 to 16: good • from 16 to 20: excellent
Channel 3	Hydraulic indicator: ratio between average Ub Velocity and Max Ub Velocity (%)	<ul style="list-style-type: none"> • Under 70%: poor quality or special structure • between 70% and 90%: circular current
Channel 4	Flow direction: 0 or 1	<ul style="list-style-type: none"> • 1: Velocity > 0 • 0: Velocity < 0

Diagnostic

- Click  **Diagnostic** to view all the parameters measured by the Ubertone sensor.

Channel	Velocity after processing
---------	---------------------------

Channel 1	Average Ub velocity
Channel 2	Standard deviation Velocity Ub
Channel 3	Max Ub velocity
Channel 4	Min Ub speed



If the collector is horizontal and at the bottom of the collector -> Pitch=Roll=90°.

These angles have no influence on the calculation, but are used to determine the position of the sensor. Their resolution to 1° also makes it impossible to measure the slope of the collector.

Measurement parameters (advanced settings)

- Click  to display the following measurement parameters.

Measurement parameters

Threshold applied to the quantity of usable echo ? <input style="width: 80px;" type="text" value="0.00"/> dB <input style="width: 20px;" type="button" value="+"/> <input style="width: 20px;" type="button" value="-"/>	Replacement velocity value if measurement are impossible ? <input style="width: 80px;" type="text" value="-8888.00"/> mm/s <input style="width: 20px;" type="button" value="+"/> <input style="width: 20px;" type="button" value="-"/>
coefficient applied to maximal velocity ? <input style="width: 80px;" type="text" value="0.80"/> <input style="width: 20px;" type="button" value="+"/> <input style="width: 20px;" type="button" value="-"/>	<div style="background-color: #00a651; color: white; padding: 5px; display: inline-block; border-radius: 5px;"> Ubertone Firmware </div>
Record temperature <input type="checkbox"/> Off	Record advanced diag data <input type="checkbox"/> Off

Threshold applied to quantity of exploitable echo : Usable echo quantity - Water bubble/particle indicator (0-40dB). **Replacement velocity value if measurement impossible** : select a value

Coefficient applied to maximum velocity

Record temperature : The sensor is fitted with a temperature probe.

Expert mode

- If expert mode is enabled, click  to display expert mode settings.

Expert mode

High Threshold applied to the Doppler SNR ? <input type="text" value="14.00"/> dB <input type="button" value="+"/> Minimum measurement value ? <input type="text" value="-1000.00"/> mm/s <input type="button" value="+"/> Quality Threshold for High Velocity ? <input type="text" value="0.25"/> <input type="button" value="+"/> Threshold applied to Doppler SNR ? <input type="text" value="6.00"/> dB <input type="button" value="+"/> coefficient applied to min velocity ? <input type="text" value="0.00"/> <input type="button" value="+"/> Record advanced diagnostics ? <input type="checkbox"/> Off	Threshold low/high velocity for standard deviation use ? <input type="text" value="200.00"/> mm/s <input type="button" value="+"/> Maximum measurement value ? <input type="text" value="4000.00"/> mm/s <input type="button" value="+"/> Quality Threshold for Low Velocity ? <input type="text" value="0.00"/> mm/s <input type="button" value="+"/> coefficient applied to average velocity ? <input type="text" value="0.00"/> <input type="button" value="+"/> Divider of the linear combination ? <input type="text" value="1.00"/> <input type="button" value="+"/>
---	---

Paramétrage en mode expert

Fifo Memory (Advanced Setting)

By default, when the logger memory is full, data are deleted in chronological order of recording, from oldest to newest.

- Click  to display advanced settings.
- If Fifo memory is disabled, change the maximum number of timestamps for the main memory (used for sending data via Internet) and the auxiliary memory (used for sending data via SMS) if necessary.

Maximum records
SMS Maximum records

Configuration summary

To view the configuration summary:

- Click [SEE OVERVIEW](#) to display a summary of the configuration.

Mapping table between DataID, channel & data

DataId	Channel	Data displayed	Units	Data Description	Data files
3	7	Debug (signed integer value)	mAh	Internal battery current consumption	*_diag.bin
6	0	Voltage	V	Instantaneous internal battery voltage (Res. 0.05 V)	*_diag.bin
6	1	Voltage	V	Minimum internal battery voltage reached (Res. 0.05 V)	*_diag.bin
6	2	Voltage	V	Instantaneous external battery	*_extbat.bin

DataId	Channel	Data displayed	Units	Data Description	Data files
				voltage (Res. 0.05 V)	
12	1	Measure temperature	°C	Sensor temperature measurement (Res. 0.1°C)	*_ubflowav.bin, *_di-ag-ubflowav.bin
17	0	GSM signal Power	dBm	GSM signal power	*_diag.bin
19	0	Date	-	POSIX time	Asynchronous data
24	0	Velocity	mm/s	Treated velocity	*_ubflowav.bin, *_di-ag-ubflowav.bin
24	1	Velocity	mm/s	Average raw velocity	*_ubflowav.bin, *_di-ag-ubflowav.bin
24	2	Velocity	mm/s	Standard deviation raw velocity	*_ubflowav.bin, *_di-ag-ubflowav.bin
24	3	Velocity	mm/s	Maximal raw velocity	*_ubflowav.bin, *_di-ag-ubflowav.bin
24	4	Velocity	mm/s	Minimal raw velocity	*_ubflowav.bin, *_di-ag-ubflowav.bin
25	0	Doppler quality signal	%	Sensor quality (0-4)	*_ubflowav.bin, *_di-ag-ubflowav.bin
25	1	Doppler quality signal	%	EchoSnr (0-40 dB)	*_ubflowav.bin, *_di-ag-ubflowav.bin
25	2	Doppler quality signal	%	DopplerSnr (0-20 dB)	*_ubflowav.bin, *_di-ag-ubflowav.bin
25	3	Doppler quality signal	%	Hydraulic indicator (%)	*_ubflowav.bin, *_di-ag-ubflowav.bin
25	4	Doppler quality signal	%	Flow direction (0 or 1)	*_ubflowav.bin, *_di-ag-ubflowav.bin
44	0	Angle	°	Roll angle (Res. 0.1°)	*_di-ag-ubflowav.bin
44	1	Angle	°	Pitch angle (Res. 0.1°)	*_di-ag-ubflowav.bin

9.6.8. Water height measurement: Low-profile Doppler (IAVL sensor)

Principle

The IAVL sensor measures the water level using a built-in piezoresistive sensor.

Configuration



Prerequisites: In Avelour, the Wiji connection to the logger must be established, see [Connecting to a logger](#).

- Click  to add a measurement configuration and select "IAVL sensor: Low Profile Doppler measurement".

Piezoresistive water level

IAVL sensor : Low Profil Doppler measurement
🗑️ ⚙️

Measurement period 15 mn ▾

[Go to power configuration menu](#)

No external power

Piezoresistive water level

Water level offset mm +/-

Water level record On

Adjustment value Calibrate

(Recorded value = measurement + offset + adjustment value)

Doppler velocity

Velocity measurement only above a level threshold On

Correct the velocity in case of a measurement error By the last valid value ▾

Information : velocity and diagnostics are null in case of a measurement error

Consider the negative velocities as null Off

Level threshold mm +/-

Doppler diagnostics record Off

Information : 3 available diagnostics : the particle density, the amount of useful signal, and the flow direction homogeneity (unit : %)

Flowrate

Height/surface table (empty) Fill table

Volume (provided that you have entered the height/surface table)

Periodic volume accumulation Inactive Hourly ▾

Off Sampler enslaving

Infinite volume accumulation Off

Off Change measure period on threshold

Off Define a threshold

⚡ Test measure
VIEW RESUME

- Enter an **offset** on the measured height if the sensor is not placed at the bottom of the structure where we wish to measure the height
- Click  calibration if necessary to adjust the value measured by the IAVL sensor with the actual height value H.

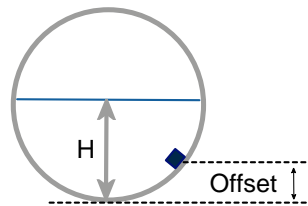

Doppler velocity

Doppler velocity

Velocity measurement only above a level threshold <input checked="" type="checkbox"/> On	Level threshold <input style="width: 80px;" type="text" value="25"/> mm <input type="button" value="-"/> <input type="button" value="+"/>
Correct the velocity in case of a measurement error <input type="text" value="By the last valid value"/>	
<small>Information : velocity and diagnostics are null in case of a measurement error</small>	
Consider the negative velocities as null <input type="checkbox"/> Off	Doppler diagnostics record <input type="checkbox"/> Off
<small>Information : 3 available diagnostics : the particle density, the amount of useful signal, and the flow direction homogeneity (unit : %)</small>	

Velocity measurement only above a level threshold : Activated by default. **Level threshold** : Threshold above which velocity measurement is active.

Correct the velocity in case of a measurement error : By the last valid value or By a specific value or No.
If By a specific value is selected: Define a **Corrective velocity**.



Velocity and diagnostics are null in case of a measurement error.

Consider the negative velocities as null : Activate if necessary.

Doppler diagnostics record : Activate if necessary.



3 quality indicators available: particle density, amount of useful signal, and flow direction homogeneity (unit: %)

Useful signal amplitude

This is a direct indication of the amount of amplification applied to the unprocessed return signal received.

- 0% means that the amplifier has been set to "10", i.e. at its maximum.
- 100% means no amplification was required.

Typically, the rate is between 40% and 75%, but a lower or even slightly higher value may simply indicate the conditions under which the device is operating. With this value, the aim is to observe a regular daily or event trend that remains consistent. If you start to observe a deterioration in this value, it probably indicates that silt, sediment or something else is beginning to accumulate on or in front of the sensor, affecting the measurement.

Particle density

Velocity measurement is based on the Doppler shift of the signal reflected by suspended particles and entrained air (bubbles) in the flow. However, reflections from other objects are also picked up, such as surface turbulence, eddy currents, stationary debris, a hanging rag upstream waving in the flow, etc... These reflections are not representative of velocity, so if they were used in processing where the unit determines average velocity, the result would be wrong. There is therefore an algorithm that eliminates these non-velocity-related components, before moving on to the weighted average process to determine the mean velocity.

As with the useful signal amplitude, the trend should be checked for consistency rather than a specific threshold. As a general rule, the rate will range from 40% to 75%, but higher or lower rates are not a bad thing. There is a lower limit: any result below 22% will result in a velocity error, as it is considered insufficient to determine a velocity.

In short, this indicator provides information on the amount of information remaining once the non-speed-related components have been eliminated from the return signal. For example, a value of 54% means that 46% of the return signal was considered to be unrelated to velocity.

Homogeneity of flow direction

This quality indicator gives the signal strength in the indicated direction of flow. The value should be equal to or close to 100% most of the time. It is possible to have a value of 100% indicating forward speed, or 100% indicating reverse speed. In all events, the desired result is 100%, or a constant HIGH number.

Bidirectional components are always present in the return signal. Even flow hitting the front end of the sensor creates a vortex, resulting in negative velocity components due to the fact that the flow has to move over or around the sensor. Other flow characteristics may also indicate the opposite direction. A highly turbulent application will have many bidirectional components

- 100% means that, whatever the direction of the reported flow, the information received in that direction is 100 times greater than in the opposite direction.
- 50% means 50 times more.
- 0% means it has received a signal indicating both forward and reverse in roughly equal proportions. 0% always means that the velocity measurement has failed and is erroneous.

Flow rate

- To calculate the flow rate, please refer to the excel form available via the link on Avelour.
- Fill in the height/surface table by clicking on .

Flowrate

Height/surface table (empty)  Fill table

Change measure period on threshold

On  Change measure period on threshold

Period on threshold	<input type="text" value="5 mn"/>		
Value Type	<input type="text" value="Height"/>	Direction	<input type="text" value="Go above a level"/>
value	<input type="text" value="10.000"/> mm <input type="button" value="−"/> <input style="float: right;" type="button" value="+"/>	Hysteresis	<input type="text" value="0.000"/> mm <input type="button" value="−"/> <input style="float: right;" type="button" value="+"/>

Define a level

On
Define a threshold

Value type	Height	Direction	Go above a level
value	10.000 mm	Hysteresis	0.000 mm
Delay to validate activation	<input type="radio"/> Inactive 0 h 0 min 0 sec	Delay to validate deactivation	<input type="radio"/> Inactive 0 h 0 min 0 sec
Record Threshold	<input checked="" type="checkbox"/> On	Anticipate data sending	No

Direction: Defines whether the measured level threshold passes **go above a level** or **on rise of at least**.

Value : Sets the height threshold.

Hysteresis : Value to be subtracted from or added to the threshold.

Delay to validate activation : Time at which threshold is reached.

Delay to validate deactivation : Time after which the threshold is no longer reached.

Anticipate data sending : Data transmission can be forced to activation, deactivation or both.

Repeat sending : If data transmission on activation is selected, enables you to modify the data transmission period.



If anticipate data sending is activated, when the threshold is reached, an alert SMS is sent to an operator if this option is configured (see [Sending an alert SMS](#)).

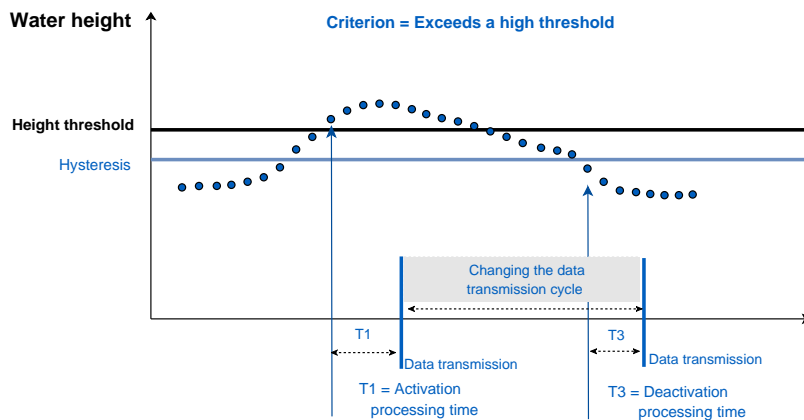

Set a second threshold

On
Define a second threshold

Value type Height ▾

value - 10.000 mm +

Direction Go above a level ▾

Hysteresis - 0.000 mm +

Delay to validate activation Active ● 0 h 0 min 0 sec

Delay to validate deactivation Inactive ● 0 h 0 min 0 sec

Record Threshold On ●

Anticipate data sending No ▾

Direction: Defines whether the measured level passes **above a high level** or **below a low level**.

Value : Height threshold.

Hysteresis : Value to be subtracted from/added to threshold.

Delay to validate activation : Time at which threshold is reached.

Delay to validate deactivation : Time after which the threshold is no longer reached.

Anticipate data sending : Data transmission can be forced to activation, deactivation or both.

Repeat sending : If a data send on activation is selected, the data can be returned after a defined period.



If anticipate data sending is activated, when the threshold is reached, an alert SMS is sent to an operator if this option is configured (see [Sending an alert SMS](#)).

Configuration summary

To view the configuration summary:

- Click SEE OVERVIEW to display a summary of the configuration.

IAVL sensor : Low Profil Doppler measurement
✖

Doppler velocity + piezoresistive water level + temperature record every **15 mins**
 Velocity measurement **only above** a water level of **25 mm Threshold(s) defined**
 Recording will last for about 10 days 10 hrs / Send around 2.9 SMS each day

⚡ Test measure
EDIT

Mapping table between DataID, channel & data

DataId	Channel	Data displayed	Units	Data Description	Data files
3	7	Debug (Entier signé)	mAh	Internal battery current consumption	*_diag.bin
6	0	Voltage	V	Instantaneous internal battery voltage (Res. 0.05 V)	*_diag.bin
6	1	Voltage	V	Minimum internal battery voltage reached (Res. 0.05 V)	*_diag.bin
6	2	Voltage	V	Instantaneous external battery voltage (Res. 0.05 V)	*_extbat.bin, *_ext-volt.bin

DataId	Channel	Data displayed	Units	Data Description	Data files
12	0	Measure temperature	°C	Sensor temperature measurement (Res. 0.1°C)	*_iavl.bin
15	0	Material height	mm	Piezoresistive water height	*_iavl.bin
17	0	GSM signal Power	dBm	GSM signal power	*_diag.bin
19	0	Date	-	POSIX time	Asynchronous data
20/0	0-7	Overflow/State	-	First threshold event	*_iavlt1.bin
20/0	0-7	Overflow/State	-	Second threshold event	*_iavlt2.bin
24	0	Velocity	mm/s	Doppler velocity	*_iavl.bin
25	0	Doppler quality signal	%	Useful signal quantity	*_iavl.bin
25	1	Doppler quality signal	%	Particle density	*_iavl.bin
25	2	Doppler quality signal	%	Homogeneity of flow direction	*_iavl.bin
34	0	Flow rate	m ³ /s	Water flow rate	*_iavl.bin
39	0-15	Volume	m ³	Infinite volume accumulation	*_iavl.bin
39	0-15	Volume	m ³	Periodic volume accumulation	*_voliavl.bin

9.6.9. Doppler velocity measurement (Nivus sensor)

Principle



The Nivus wedge and cylindrical sensors measure velocity by the Doppler effect. Placed opposite to the direction of flow, the principle is to measure the speeds of bubbles and/or particles present in water. The hypothesis being that they move at the same speed as water.

Configuration



Prerequisites: In Avelour, the Wiji connection to the logger must be established, see [Connecting to a logger](#).

- Click  to add a measurement configuration and select "Nivus sensor: Doppler speed measurement".

Nivus sensor : Doppler velocity measure  

Measure period 15 mn -
[Go to power configuration menu](#)
No external power

Doppler parameters

Transmit frequency 1000 kHz (Wedge sensor) -
 Damping (s) 5.00 s +

Temperature record off
 Doppler measure quality record off

Piezoresistive height record off

Caution! Ensure you that the Doppler sensor is equipped with a pressure cell

 Test measure
VIEW RESUME

Doppler settings

Transmit frequency : Select the sensor type *wedge 1000 kHz* or *cylindrical 750 kHz*.

Damping period (s): Sliding average over time (minimum and by default 5 seconds).

- Activate recording of the following data as necessary:
 - temperature
 - Doppler measurement quality
 - piezoresistive height (1000 kHz wedge sensor)



Verify that the Doppler sensor is properly equipped with a pressure sensor.

Configuration summary

To view the configuration summary:

- Click [SEE OVERVIEW](#) to display a summary of the configuration.

Nivus sensor : Doppler velocity measure 

Velocity + temperature measure every **15 mins**
Recording will last for about 1 yr 5 mths / Send around 1.9 SMS each day

 **Test measure** **EDIT**

9.6.10. Doppler velocity and overflow measurement (Nivus sensor)

Principle

The Nivus wedge and cylindrical sensors measure velocity by the Doppler effect. Placed in the opposite direction to the flow, its principle is to measure the velocities of bubbles and/or particles present in the water, assuming that they are moving at the same speed as the water.



The NIVUS sensor makes it possible to measure the water level using a built-in piezoresistive sensor.

Configuration



Prerequisites: In Avelour, the Wiji connection to the logger must be established, see [Connecting to a logger](#).

- Click  to add a measurement configuration and select "Nivus sensor: Doppler velocity measure and overflow (optional flow)".

Nivus sensor : Doppler velocity measure and overflow (optional flow)
 

Measure period 15 mn

[Go to power configuration menu](#)
No external power

Doppler parameters

Transmit frequency 1000 kHz (Wedge sensor) Damping (s) 5.00 s

Temperature record off Doppler measure quality record off

off Options Height / Flow for Doppler sensors with integrated piezoresistive height measure

Overflow configuration

Overflow detector device Contact input/Counter 1-100Hz (13) Overflow detector device Wired as normally open (NO)

Measure period when no overflow inactive 1 h

Record overflows off Repeat data sending when in overflow off

Set the minimum delay between 2 data sending in the 'Data sending' tab

VIEW RESUME

Doppler parameters

Transmit frequency : Select sensor type *wedge 1000 kHz* or *cylindrical 750 kHz*.

Damping period(s): Sliding average over time (minimum 5 seconds)

Temperature record  : The sensor is fitted with a temperature probe.

Doppler measure quality record 

Height / Flow options for Doppler sensor with integrated piezoresistive height measure

On Options Height / Flow for Doppler sensors with integrated piezoresistive height measure

Piezoresistive height record <input type="checkbox"/>	Height correction Offset <input style="width: 50px;" type="text" value="0"/> mm	Calibrate	Fill table
Adjustment value <input style="width: 50px;" type="text" value="0mm"/> <small>(Recorded value = measurement + offset + adjustment value)</small>	<small>Flow conversion with height/surface table (empty)</small>		

- Activate **Piezoresistive height record** if necessary.
- Enter an offset on the measured height if the sensor is not placed at the bottom of the structure where we wish to measure the height.

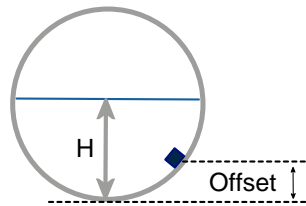

- Click [Calibrate](#) if necessary to adjust the value measured by the IAVL sensor to the actual height value.
- Fill in the height/surface table by clicking on [Fill table](#).

Overflow configuration

Overflow sensor peripheral device: see [M12 8-pin connector](#)

- Activate a **Velocity measurement period excluding overflow** to change the measure period.
- Activate **overflow recording** to record overflow states (0 or 1).
- Activate the **Periodic overflow data transmission** and in this case enter the minimum time between two data transmissions (see [Configure an alarm](#)).

Configuration summary

To view the configuration summary:

- Click [SEE OVERVIEW](#) to display a summary of the configuration.

Nivus sensor : Doppler velocity measure and overflow (optional flow) ✖

Velocity measurement every **15 mins on overflow** / never out of overflow
Inactive recording of overflows, **normally open** wiring
 Recording will last for about 1 yr 5 mths / Send around 1 SMS each day

[EDIT](#)

9.6.11. Flow measurement: Doppler speed + built-in piezoresistive height (Nivus sensor)

Principle

The NIVUS sensor makes it possible to measure the water level using a built-in piezoresistive sensor.

Configuration



Prerequisites: In Avelour, the Wiji connection to the logger must be established, see [Connecting to a logger](#).

- Click to add a measurement configuration and select "Nivus sensor: Doppler speed + integrated piezoresistive height -> Flow".

Combined Doppler speed/piezoresistive height sensor

Doppler velocity sensor with integrated piezoresistive height

Doppler velocity record <input type="checkbox"/> Off	Temperature record <input type="checkbox"/> Off
Doppler measure quality record <input type="checkbox"/> Off	
Height correction Offset <input type="text" value="0"/> mm <input type="button" value="+"/>	Adjustment value <input type="text" value="0mm"/> <input type="button" value="Calibrate"/>

(Recorded value = measurement + offset + adjustment value)

Off Change measure period on height threshold

- Enter an **offset** on the measured height if the sensor is not placed at the bottom of the structure where we wish to measure the height **H**.

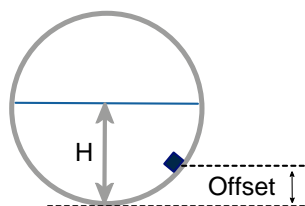

- Click Calibrate if necessary to adjust the measured value with the actual height value.

Modifying the frequency of measurements on a measurement threshold

- Activate as needed **change measure period on height threshold** to view configuration settings.

Modification of measures to: New measurement frequency.

Direction: Defines whether the measured level exceeds a **high threshold** or a **low threshold**.

Height : Threshold to be reached to activate modification. **Hysteresis :** Value to be subtracted (high threshold) or added (low threshold) to the level at which the measurement frequency returns to its initial value.

Minimum time before deceleration : Hold time for the new measurement frequency before returning to its initial value.

Example below: The measurement frequency increases from 15 minutes to 2 minutes if the water level exceeds 500 mm. When the water level falls below the threshold of 400 mm, it returns to 15 minutes.

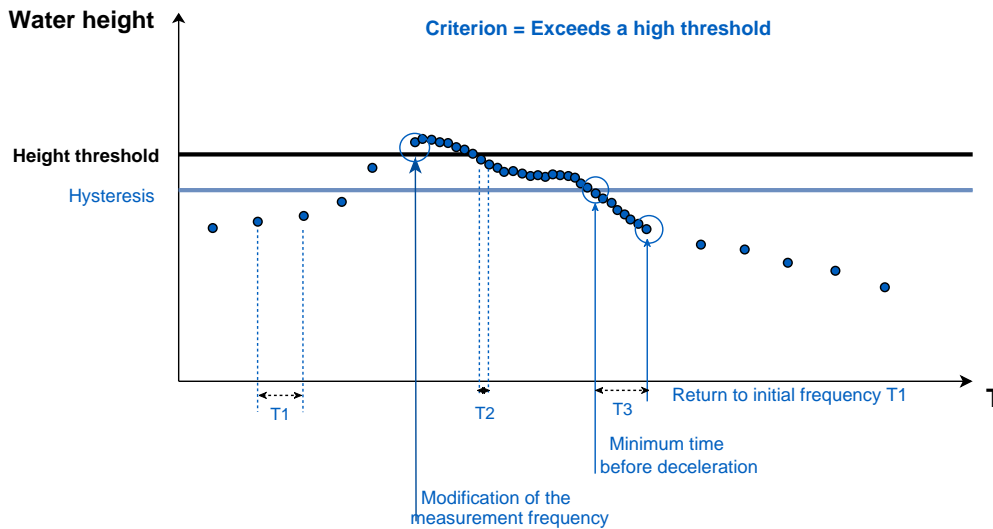

Doppler settings

Transmit frequency : Choice of the type of sensor, wedge 1000 kHz or cylindrical 750 kHz.

Damping period (s): Sliding average over time (minimum 5 seconds).

Doppler parameters	
Transmit frequency	1000 kHz (Wedge sensor) - Damping (s) <input type="text" value="5.00"/> s <input type="button" value="+"/>

Debit

- To calculate the flow rate, refer to the excel form available via the link on Avelour.
- Fill in the height/surface table by clicking on .

Flowrate	
Height/surface table (empty)	<input type="button" value="Fill table"/>

Fifo Memory (Advanced Setting)

By default, when the logger memory is full, data are deleted in chronological order of recording, from oldest to newest.

- Click  to display advanced settings.
- If Fifo memory is disabled, change the maximum number of timestamps for the main memory (used for sending data via Internet) and the auxiliary memory (used for sending data via SMS) if necessary.

Maximum records	<input type="text" value="50000"/>	SMS Maximum records	<input type="text" value="50000"/>
-----------------	------------------------------------	---------------------	------------------------------------

Configuration summary

To view the configuration summary:

- Click [SEE OVERVIEW](#) to display a summary of the configuration.

Nivus sensor : Doppler velocity + integrated piezoresistive height -> Flow 

Water height measure every **15 mins**
Changed measurement period 5 mins, when the measure Go above a level at **100mm**, Hysteresis : 100mm
Recording will last for about 1 yr 5 mths (5 mths with changed period) / Send around 1 SMS each day (2.9 with changed period)

 **Test measure** **EDIT**

9.6.12. Physical-chemical measurement

Principle

C4E physical-chemical sensor:

The electrode uses 4-electrode technology: an alternating current of constant voltage is established between a pair of primary graphite electrodes. Secondary platinum electrodes make it possible to regulate the voltage imposed on the primary electrodes, to take account of fouling. The voltage measured between the primary electrodes depends on the resistance of the medium and therefore of its conductivity.

CTZN physical-chemical sensor

A toroidal coil is excited at a fixed frequency and the response is retrieved on a second coil aligned on the first. The coupling depends on conductivity and occurs through the intermediary of the conductive solution.

NTU physical-chemical sensor

The measurement principle is based on nephelometry: a diode emits an Infra-Red light (880nm) and a receiving diode placed at 90° measures the scattered radiation (normalized measurement). The sensor can be calibrated using a Formazine standard.

OPTOD physical-chemical sensor

The OPTOD® dissolved oxygen sensor uses optical luminescence measurement technology approved by ASTM International Method D888-05. This innovative method ensures reliable, accurate measurements without calibration. The OPTOD sensor enables an immediate return on investment as it requires no consumables or maintenance. Only the DoDisk needs to be changed every two years. As it does not consume oxygen, the OPTOD sensor is suitable for all environments, including those with very low water circulation.

PHEHT physical-chemical sensor

The sensor integrates an Ag/AgCl type reference electrode, used for pH and Redox measurements, with a plasticized electrolyte saturated with KCl "PLASTOGEL"®.

The "PLASTOGEL"® electrolyte communicates directly with the external environment without the interposition of capillaries or pores. There is therefore no risk of blocking or de-priming the reference. The measurement electrodes take the form of a special glass bulb sensitive to pH and soldered to the end of a crystal tube for pH and in the form of a platinum tip for redox.

Configuration



Prerequisites: In Avelour, the Wiji connection to the logger must be established, see [Connecting to a logger](#).

The sensor is connected to the logger.

- Click  to add a measurement configuration and select "Physicochemical measurement (conductivity, turbidity, pH, dissolved oxygen)".
- Select a period between each measurement from the list. In the example above, a measurement will be taken every 15 minutes.

Physicochemical measure (conductivity, turbidity, pH, dissolved oxygen)
🗑️ 🛠️

Measure period 15 mn ▾

[Go to power configuration menu](#)

No external power

Power supply delay - 800.00 ms +

Off C4E conductivity sensor

Off CTZ induction conductivity sensor

Off NTU turbidity sensor

Off PHEHT Ph and Redox sensor

Off OPTOD optical dissolved oxygen sensor

VIEW RESUME

Power supply

It is possible to power an external sensor directly from the internal battery of the logger. In this case, no specific settings are required.

It is also possible to use an external battery or AC power supply (7-30 V).

- If an external power supply (battery or mains) is connected to the logger, refer to paragraph [Using a power pack](#)

By default, the power supply delay is set to 800 ms.

C4E conductivity sensor ●

Data to record : Conductivity or salinity or Conductivity + salinity.

Measurement range : Corresponds to the measurement range of the sensor according to the expected levels.

- Click the  button to start a test measurement and display the result.

Define a threshold

- See [the section called "Define a threshold"](#).

Change the measurement period (advanced setting)

- Click  to display the measurement period parameter (4000 ms by default).

Change Modbus ID

- Click  to view and edit the **Modbus ID**.

CTZ induction conductivity sensor ●

Data to record : Salinity (g/kg), Conductivity (µS/cm), Conductivity + Salinity (µS/cm)

Measurement range : Corresponds to the measurement range of the sensor according to the expected levels.

- Click the  button to start a test measurement and display the result.

Define a threshold

- See [the section called "Define a threshold"](#).

Change the measurement period (advanced setting)

- Click  to show the setting for **measurement period** (4000 ms by default).

Change Modbus ID

- Click  to view and edit the **Modbus ID**.

NTU turbidity sensor

Data to record : FNU Turbidity (FNU), Turbidity (FNU + TU), or Turbidity (TU) (mg/L)

Measurement range : Corresponds to the measurement range of the sensor according to the expected levels.

- Click the  button to start a test measurement and display the result.

Define a threshold

- See [the section called "Define a threshold"](#).

Change the measurement period (advanced setting)

- Click  to display the measurement period parameter (4000 ms by default).

Change Modbus ID

- Click  to view and edit the **Modbus ID**.

PHEHT Ph and Redox sensor

Data to record : pH, Redox (mV) or pH + Redox

Measurement range : Corresponds to the measurement range of the sensor according to the expected levels.

- Click the  button to start a test measurement and display the result.

Define a threshold

- See [the section called "Define a threshold"](#).

Change Modbus ID

- Click  to view and edit the **Modbus ID**.

OPTOD optical dissolved oxygen sensor

Data to record : *Oxygen saturation (%Sat), Dissolved oxygen (mg/L) or Dissolved oxygen + saturation.*

Measurement range : Corresponds to the measurement range of the sensor according to the expected levels.

- Click the  button to start a test measurement and display the result.

Define a threshold

- See [the section called "Define a threshold"](#).

Check correct sensor operation

- Click  to view the measured values.

-> The connection to the device is activated and a new window displays the measured values.

Change Modbus ID

- Click  to view and edit the **Modbus ID**.

Define a threshold

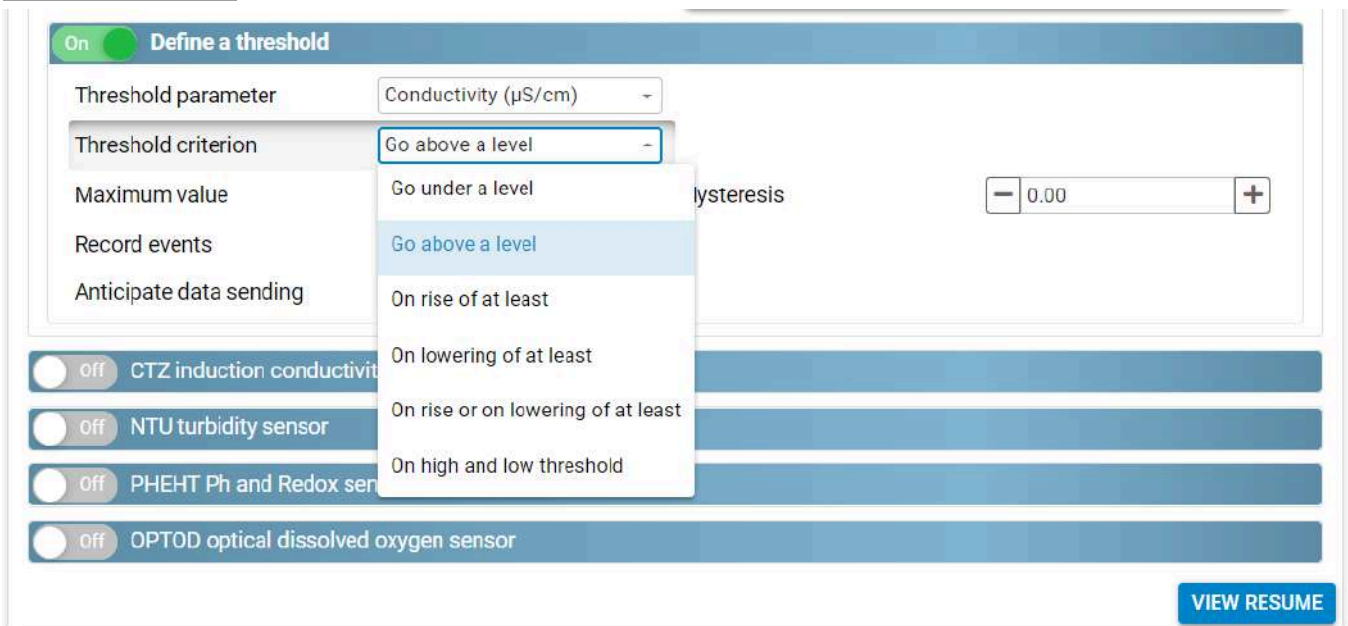

Threshold parameter : Measurement parameter to select according to the type of sensor.

Threshold criterion : Criterion defining the type of crossing:

- Go below a level: measured level passes below the configured threshold.
- Go above a high level: the measured level exceeds the configured threshold.
- On rise of at least: the value between 2 measurements exceeds the configured threshold.
- On high and low threshold: measured level exceeds the high threshold or drops below the low threshold.

Hysteresis : Value to be subtracted/added to the threshold **Record events** : Threshold crossing state = 0 or 1. for which its state is deactivated.

Anticipate data sending : Data transmission may be forced upon activation, deactivation or both. **Repeat sending** : If data transmission on activation is selected, enables you to modify the data transmission period.



If anticipate data sending is activated, an alert SMS is sent to an operator when the threshold is reached, if this option is configured (see [Sending an alert SMS](#)).

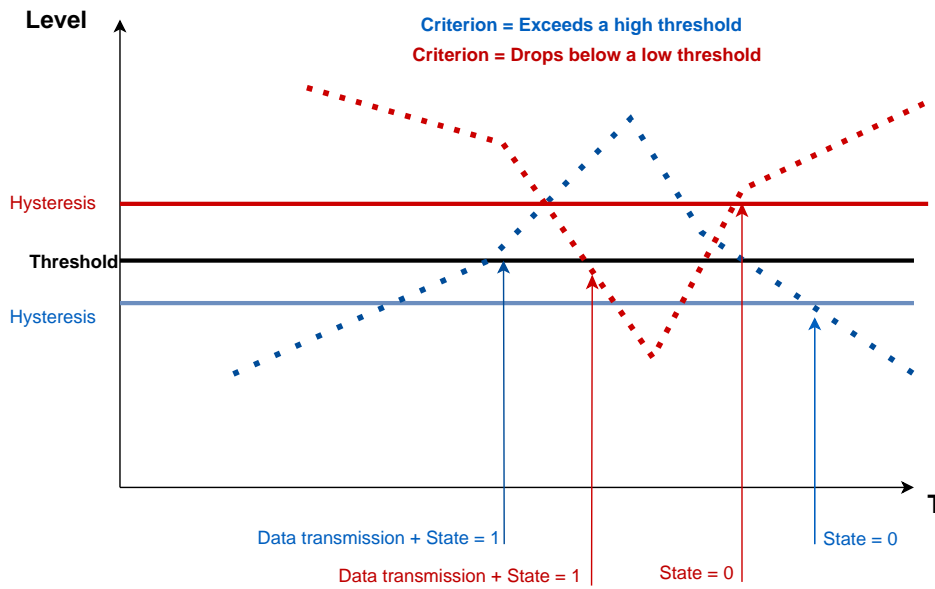
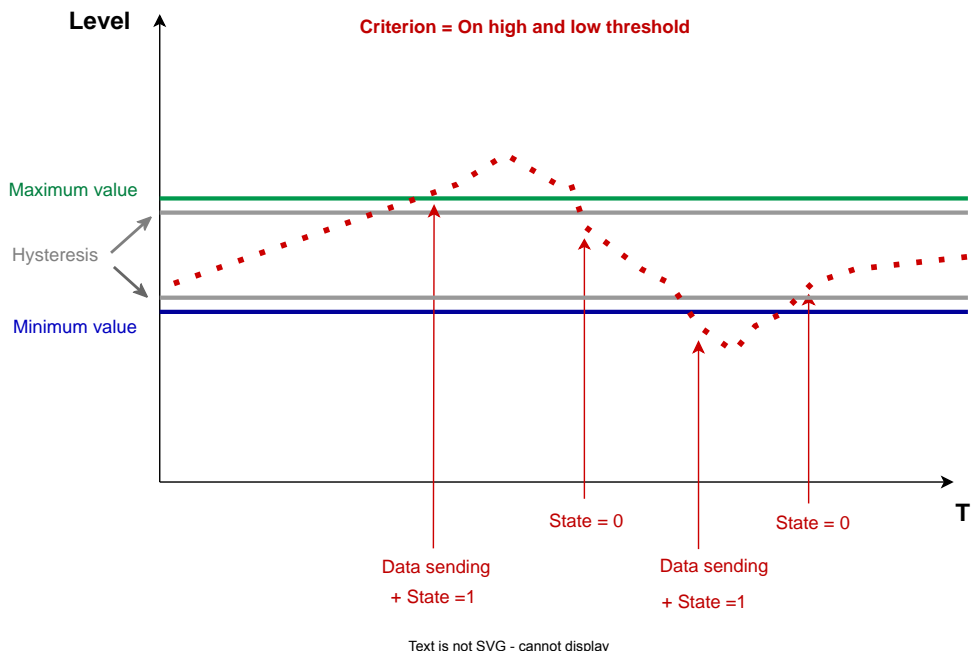

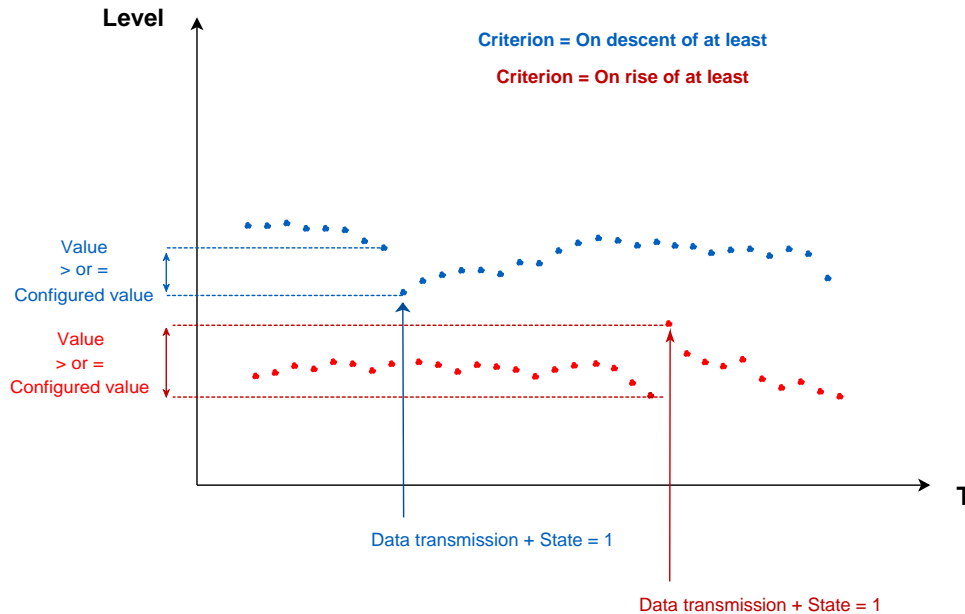

Fifo Memory (Advanced Setting)

By default, when the logger memory is full, data are deleted in chronological order of recording, from oldest to newest.

- Click  to display advanced settings.
- If Fifo memory is disabled, change the maximum number of timestamps for the main memory (used for sending data via Internet) and the auxiliary memory (used for sending data via SMS) if necessary.

Maximum records SMS Maximum records

Configuration summary

To view the configuration summary:

- Click [SEE OVERVIEW](#) to display a summary of the configuration.

Physicochemical measure (conductivity, turbidity, pH, dissolved oxygen) 

Physicochemical measurement every **15 mins**

Sensor **C4E** : Recording of **Conductivity + Salinity** / Range : **Automatic**

Conductivity (µS/cm) threshold according to the criterion : **Go above a level 0**, with **recording of events**, with **anticipated data sending**

Recording will last for about 10 days 10 hrs / Send around 1.9 SMS each day

[EDIT](#)

Mapping table between DataID, channel & data

DataId	Channel	Data displayed	Units	Data Description	Data files
0	0	State	-	Threshold event for conductivity C4E sensor	*_eventC4E.bin

DataId	Channel	Data displayed	Units	Data Description	Data files
0	1	State	-	Threshold event for conductivity CTZ sensor	*_eventCTZ.bin
0	2	State	-	Threshold event for turbidity NTU sensor	*_eventNTU.bin
0	3	State	-	Threshold event for pH and Redox PHEHT sensor	*_eventPHEHT.bin
0	4	State	-	Threshold event for oxygen OPTOD sensor	*_eventOPTOD.bin
3	7	Debug (signed integer value)	mAh	Internal battery current consumption	*_diag.bin
6	0	Voltage	V	Instantaneous internal battery voltage (Res. 0.05 V)	*_diag.bin
6	1	Voltage	V	Minimum internal battery voltage reached (Res. 0.05 V)	*_diag.bin
6	2	Voltage	V	Instantaneous external battery voltage (Res. 0.05 V)	*_extvolt.bin, *_extbat.bin
12	0	Measure temperature	°C	C4E conductivity sensor temperature measurement (Res. 0.1°C)	*_ponsel.bin
12	1	Measure temperature	°C	CTZ conductivity sensor temperature measurement (Res. 0.1°C)	*_ponsel.bin
12	2	Measure temperature	°C	NTU turbidity sensor FNU temperature measurement (Res. 0.1 °C)	*_ponsel.bin
12	3	Measure temperature	°C	PHEHT pH and Redox sensor temperature measurement (Res. 0.1 °C)	*_ponsel.bin
12	4	Measure temperature	°C	OPTOD oxygen sensor temperature measurement (Res. 0.1 °C)	*_ponsel.bin
17	0	GSM signal Power	dBm	GSM signal power	*_diag.bin
19	0	Date	-	POSIX time	Asynchronous data
26	0	Conductivity	µS/cm	C4E conductivity sensor conductivity measurement	*_ponsel.bin
26	1	Conductivity	µS/cm	CTZ conductivity sensor conductivity measurement	*_ponsel.bin
27	0	Salinity	g/kg	C4E conductivity sensor salinity measurement	*_ponsel.bin
27	1	Salinity	g/kg	CTZ conductivity sensor salinity measurement	*_ponsel.bin
28	4	Oxygen saturation	%	OPTOD oxygen sensor oxygen saturation measurement	*_ponsel.bin
29	4	Dissolved oxygen	mg/l	OPTOD oxygen sensor dissolved oxygen measurement	*_ponsel.bin
30	3	pH	-	PHEHT pH and Redox sensor pH measurement	*_ponsel.bin

DataId	Channel	Data displayed	Units	Data Description	Data files
31	3	Redox	mV	PHEHT pH and Redox sensor Redox measurement	*_ponsel.bin
32	2	FNU turbidity	FNU	NTU turbidity sensor FNU turbidity measurement	*_ponsel.bin
33	2	TU turbidity	mg/l	NTU turbidity sensor TU turbidity measurement	*_ponsel.bin

9.6.13. Conductivity measurement (B&C sensor)

Principle

The B&C sensor is used to measure conductivity by induction. An electric current passes through an emission coil to induce a magnetic field in the liquid. A current is then applied to the ions present in the liquid. This current is measured by a receiving coil and makes it possible to define the conductivity of the liquid.

Configuration



Prerequisites: In Avelour, the Wiji connection to the logger must be established, see [Connecting to a logger](#).

- Click  to add a measurement configuration and select "B&C sensor".

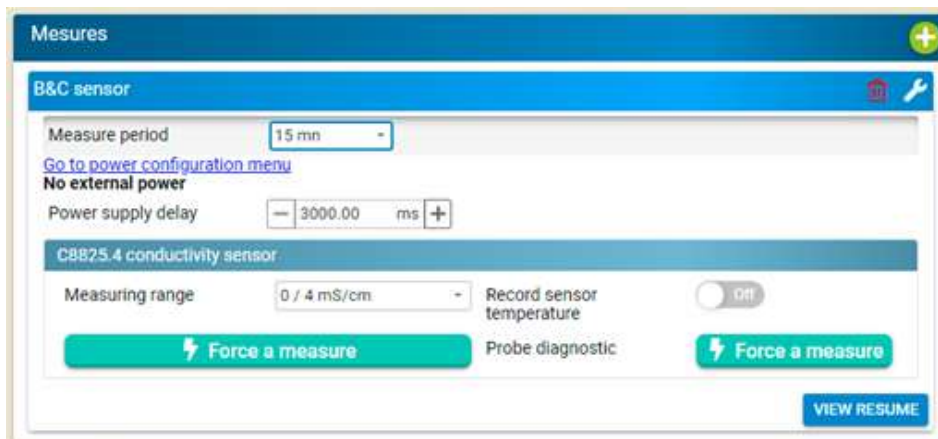

Measurement parameters with a B&C sensor

Measure period

- From the list, select a length of time between each measurement. In the example above, a measurement will be taken every 15 minutes.

Power supply

It is possible to power an external sensor directly from the internal battery of the logger. In this case, no specific settings are required.

It is also possible to use an external battery or AC power supply (7-30 V).

- If an external power supply (battery or mains) is connected to the logger, refer to paragraph [Using a power pack](#)

For the B&C sensor, the possible voltage ranges from a minimum of 9 V to a maximum of 36 V.

By default, the power supply delay is set at 3000 ms (3 seconds), which corresponds to the time required for the B&C conductivity sensor.

Measuring range



Two different ranges are available: 0 — 4 mS/cm or 0 — 200 mS/cm

- Select the range according to the expected conductivity values.

Temperature

- Activate  recording of the temperature measured by the sensor if necessary.

View measured values

- Click the button  on the left to display the measured conductivity and temperature values.
- Click the button  on the right to show the sensor configuration.

Fifo Memory (Advanced Setting)

By default, when the logger memory is full, data are deleted in chronological order of recording, from oldest to newest.

- Click  to display advanced settings.
- If Fifo memory is disabled, change the maximum number of timestamps for the main memory (used for sending data via Internet) and the auxiliary memory (used for sending data via SMS) if necessary.

Maximum records SMS Maximum records

Configuration summary

- Click [SEE OVERVIEW](#) to display a summary of the configuration.

Depending on the parameters selected, the recording time remaining before the memory is full is also given, as well as an average of the number of text messages sent per day.

B&C sensor 

Measurement every 15 mins
Recording of conductivity / Range : 0 / 4 mS/cm
Recording will last for about 1 yr 5 mths / Send around 1 SMS each day

[EDIT](#)

9.6.14. Measurement using an ISCO signature flow meter

Principle



The Signature flow meter is designed for open channel flow monitoring applications, using any combination of sampling and measurement technologies for flow rates and other parameters, and as required by the monitoring site.

Configuration



Prerequisites: In Avelour, the Wiji connection to the logger must be established, see [Connecting to a logger](#).

- Click  to add a measurement configuration and select "ISCO Signature flow meter".

Signature Flow Meter ISCO  

Datalogging period 15 mn ▾

Information : For each data, the recording channels respect the assigned order when configuring the Signature

Datalogging

? Registers table
[More informations here](#)
✕

Level(s)	<input type="checkbox"/> Off
Temperature(s)	<input type="checkbox"/> Off
Velocity(ies)	<input type="checkbox"/> Off
Volume(s)	<input type="checkbox"/> Off
Flowrate(s)	<input type="checkbox"/> Off
pH(s)	<input type="checkbox"/> Off
Conductivity(ies)	<input type="checkbox"/> Off

Modbus configuration

Signature Flow Meter ID	- 2 +	Protocol Type	RTU ▾
Baud	9600 ▾	Data bits	8 ▾
Parity	Aucun ▾	Stop bits	1 ▾

VIEW RESUME

Datalogging period

- From the list, select a length of time between each measurement. In the example above, a measurement will be taken every 15 minutes.



Information: For each data element, the recording channels respect the order assigned during configuration of the Signature flow meter

Data to record

It is possible to view a document by clicking on the link " More information here ". For each data element measured by an Ijinus logger, this document named "Modbus Tables" describes the address, the offset, the size and the encoding (integer, inverted integer, etc.).

Depending on the type of application chosen in the drop-down menu shown below, the table applied (and therefore the data encoding) will not be the same. You must therefore use the correct register table to be able to send the desired measurements to the PLC.

- Activate the data to be recorded as needed.
- Select the recording **Number** of the parameter activated based on the Signature flowmeter configuration.

Fifo Memory (Advanced Setting)

By default, when the logger memory is full, data are deleted in chronological order of recording, from oldest to newest.

- Click  to display advanced settings.
- If Fifo memory is disabled, change the maximum number of timestamps for the main memory (used for sending data via Internet) and the auxiliary memory (used for sending data via SMS) if necessary.

Maximum records

SMS Maximum records

Modbus configuration



These parameters must coincide exactly with the parameters expected by the controller connected to the Ijinus logger.

Configuration summary

To view the configuration summary:

- Click [SEE OVERVIEW](#) to display a summary of the configuration.

Signature Flow Meter ISCO

Datalogging every **15 mins**
 Modbus configuration : ID **2**, RTU protocol, **9600** Baud, **8** data bits, **none** parity, 1 stop bit(s)
 Recording will last for about 1 yr 5 mths / Send around 6.7 SMS each day
 Caution, the minimum requirement for the firmware of the Signature FlowMeter is 1.23

[EDIT](#)

Mapping table between DataID, channel & data

DataId	Channel	Data displayed	Units	Data Description	Data files
3	7	Debug (signed integer value)	mAh	Internal battery current consumption	*_diag.bin
6	0	Voltage	V	Instantaneous internal battery voltage (Res. 0.05 V)	*_diag.bin

DataId	Channel	Data displayed	Units	Data Description	Data files
6	1	Voltage	V	Minimum internal battery voltage reached (Res. 0.05 V)	*_diag.bin
6	2	Voltage	V	Instantaneous external battery voltage (Res. 0.05 V)	*_extbat.bin, *_extvolt.bin
12	0	Measure temperature	°C	Sensor 1 temperature measurement (Res. 0.1°C)	*_signISCO_0.bin
12	1	Measure temperature	°C	Sensor 2 temperature measurement (Res. 0.1°C)	*_signISCO_0.bin
12	2	Measure temperature	°C	Sensor 3 temperature measurement (Res. 0.1°C)	*_signISCO_0.bin
12	3	Measure temperature	°C	Sensor 4 temperature measurement (Res. 0.1°C)	*_signISCO_0.bin
15	0	Material height	mm	Sensor 1 water height	*_signISCO_0.bin
15	1	Material height	mm	Sensor 2 water height	*_signISCO_0.bin
15	2	Material height	mm	Sensor 3 water height	*_signISCO_0.bin
15	3	Material height	mm	Sensor 4 water height	*_signISCO_0.bin
17	0	GSM signal Power	dBm	GSM signal power	*_diag.bin
19	0	Date	-	POSIX time	Asynchronous data
24	0	Velocity	mm/s	Sensor 1 water velocity	*_signISCO_1.bin
24	1	Velocity	mm/s	Sensor 2 water velocity	*_signISCO_1.bin
24	2	Velocity	mm/s	Sensor 3 water velocity	*_signISCO_1.bin
24	3	Velocity	mm/s	Sensor 4 water velocity	*_signISCO_1.bin
26	0	Conductivity	µS/cm	Sensor 1 water conductivity	*_signISCO_2.bin
26	1	Conductivity	µS/cm	Sensor 2 water conductivity	*_signISCO_2.bin
26	2	Conductivity	µS/cm	Sensor 3 water conductivity	*_signISCO_2.bin
26	3	Conductivity	µS/cm	Sensor 4 water conductivity	*_signISCO_2.bin
30	0	pH	-	Sensor 1 water pH	*_signISCO_2.bin
30	1	pH	-	Sensor 2 water pH	*_signISCO_2.bin
30	2	pH	-	Sensor 3 water pH	*_signISCO_2.bin
30	3	pH	-	Sensor 4 water pH	*_signISCO_2.bin
34	0	Flow rate	m3/s	Sensor 1 water flow rate	*_signISCO_0.bin
34	1	Flow rate	m3/s	Sensor 2 water flow rate	*_signISCO_0.bin
34	2	Flow rate	m3/s	Sensor 3 water flow rate	*_signISCO_0.bin
34	3	Flow rate	m3/s	Sensor 4 water flow rate	*_signISCO_0.bin
39	0	Volume	m3	Sensor 1 water volume	*_signISCO_0.bin
39	1	Volume	m3	Sensor 2 water volume	*_signISCO_0.bin
39	2	Volume	m3	Sensor 3 water volume	*_signISCO_0.bin

Datald	Channel	Data displayed	Units	Data Description	Data files
39	3	Volume	m3	Sensor 4 water volume	*_signISCO_0.bin

9.6.15. Configure a wired modbus display on push-button

Operation

Data from the wired sensor is displayed by pressing the push button below the display.



The modem and the display cannot work simultaneously. Priority is given to the one that is currently in operation.

If the display is active, activation of the modem (data transmission) is postponed for 60 seconds.

Display configuration



Prerequisite: In Avelour, the Wiji connection to the logger must be established, see. [Connecting to a logger](#)

- Click on  to add a measurement configuration and select “ Modbus wired display with switch”.



By default, when the display button is pressed, a measurement is taken. It is then possible to activate  logging of this measurement.

Configuration summary

To view the configuration summary:

- Click on  to display a summary of the configuration.



9.6.16. Wired overflow detector

Principle

An OVERFLOW overflow detector can record the number and duration of overflows and communicate them if physically connected to the logger.

An OVERFLOW overflow detector operates using an air-reference capacitive measurement that consumes very little energy.

The OVERFLOW detector takes into account elements in physical contact with the housing and up to a few centimeters away from it. The detector is highly insensitive to fouling. It is possible to adjust the overflow recording threshold to take account of restrictive external conditions in particularly congested networks.

Configuration



Prerequisites: In Avelour, the Wiji connection to the logger must be established, see [Connecting to a logger-parameters](#).

- Click  to add a measurement configuration and select "Wired overflow".

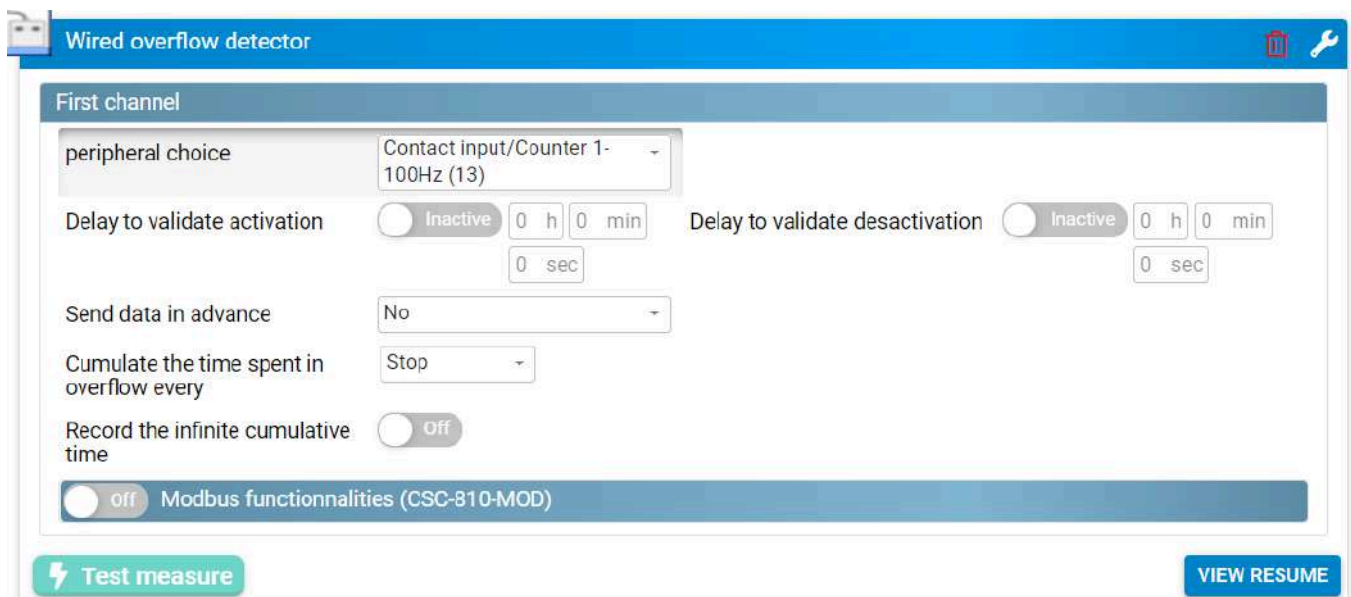

Configuration

Activation / deactivation processing time  : A time delay can be set for activation and deactivation of the overflow state.

Anticipate data transmission : Data transmission can be forced to activation, deactivation or both overflow states.

Repeat transmission  : Activates modification of the data transmission cycle.

Cumulate the time spent in overflow all the: Define a recording frequency for cumulative time spent in overflow.

Modbus functionalities (CSC-810-MOD)

Read the configured detection threshold : Click  to display the threshold set on the detector.

CSC slave address  select the expected channel as configured in Modbus master.

Modify the detection threshold

Desired detection threshold: define the percentage of the capacitive saturation detection threshold.



A 5% hysteresis is set on the capacitive saturation value threshold before state change. This means that for a value set at 80%, the overflow state will no longer be active as soon as the value falls below 75%.

- Click  **Run** so that the updated detection threshold is taken into account on the detector.

Configuration summary

To view the configuration summary:

- Click  to display a summary of the configuration.

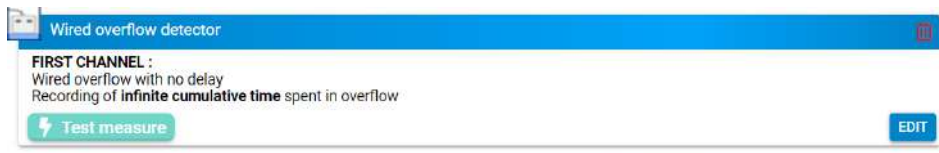

Table of correspondences (Data ID / Channel / files)

Datald	Channel	Data displayed	Units	Data Description	Data files
6	0	Voltage	V	Instantaneous internal battery voltage (Res. 0.05 V)	*_diag.bin
6	1	Voltage	V	Minimum internal battery voltage reached (Res. 0.05 V)	*_diag.bin
7	0	Voltage	V	Instantaneous internal overflow battery voltage (Res. 0.01 V) - Channel 1	*_diagOv.bin
7	1	Voltage	V	Instantaneous internal overflow battery voltage (Res. 0.01 V) - Channel 2	*_diagOv.bin
11	0	System temperature	°C	System temperature of the overflow device - Channel 1	*_mbCap.bin
11	1	System temperature	°C	System temperature of the overflow device - Channel 2	*_mbCap2.bin
17	0	GSM signal Power	dBm	GSM signal power	*_diag.bin
19	0	Date	-	POSIX time	Asynchronous data
20	0	Overflow	-	Overflow status - Channel 1	*_ovhard.bin
20	1	Overflow	-	Overflow status - Channel 2	*_ovhard2.bin
23	0	Capacitive saturation	%	Capacitive saturation of the overflow device - Channel 1	*_mbCap.bin

DataId	Channel	Data displayed	Units	Data Description	Data files
23	1	Capacitive saturation	%	Capacitive saturation of the overflow device - Channel 2	*_mbCap2.bin
40	0	Duration	s	Cumulated time spent in overflow on defined period - Channel 1	*_ovhReport.bin
40	1	Duration	s	Infinite cumulated time spent in overflow - Channel 1	*_ovhard.bin
40	2	Duration	s	Cumulated time spent in overflow on defined period - Channel 2	*_ovhReport2.bin
40	3	Duration	s	Infinite cumulated time spent in overflow - Channel 2	*_ovhard2.bin

9.6.17. Modbus master

Principle

The modbus master configuration is a tool for performing read, write and delay operations directly in modbus 485 communication.

Configuration



The configuration of the recorder in modbus master mode is intended for expert users to configure products directly in modbus 485 communication. It therefore represents an alternative to the products/tools directly integrated by Ijinus. However, it is important to know the prerequisites for using this tool.



Prerequisites: In Avelour, the Wiji connection to the logger must be established, see [Connecting to a logger](#).

- Click  to add a measurement configuration and select "Modbus master".

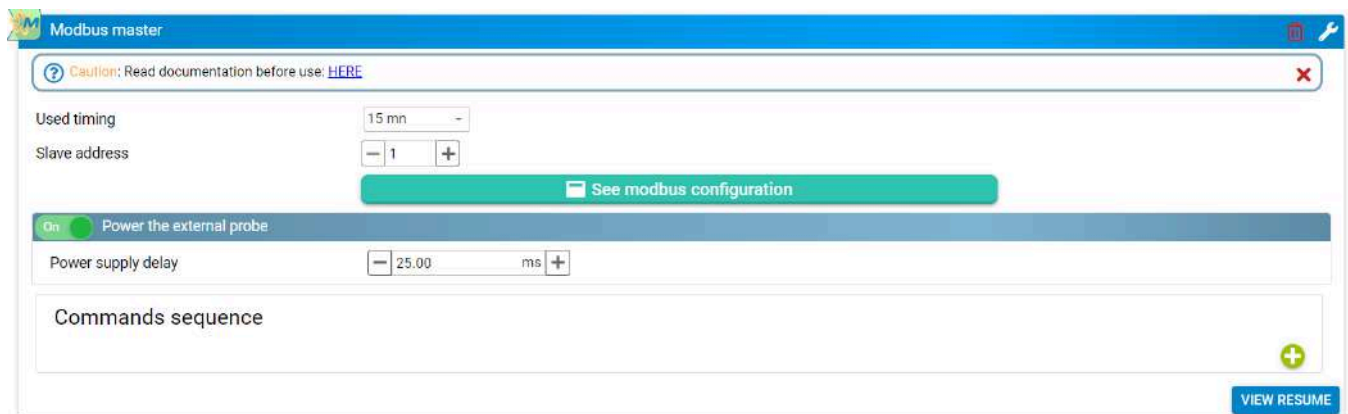

Modbus configuration



It is essential that these parameters match exactly with the product connected in modbus slave.

Modbus configuration			
Mode	RTU	Baudrate	9600
Data bits	8	Parity	Aucun
Stop bits	1	Timeout (Modbus request)	250.00 ms

CLOSE

Default master modbus configuration

Sequence of commands

Read register

Read register commands are limited to 8 maximum.

To add a register reading, click .

Read Modbus register

name	<input type="text" value="Vmax"/>
Address	<input type="text" value="85"/>
Format	<input type="text" value="Unsigned 16 -"/>
Byte order	<input type="text" value="AB -"/>
Function Code	<input type="text" value="Read Holding Registers (0x03) -"/>
Output Type	<input type="text" value="Debug (positive integer value) [2] -"/>
Conversion	value= <input type="text" value="1"/> * (x + <input type="text" value="0"/>) + <input type="text" value="0"/>

- Modbus function 0x03 or 0x04
- Format of the data read: Unsigned16, Signed16, Unsigned32, Signed32, Float
- **Byte order** possible depending on the format: AB, BA, ABCD (W1W2), DCBA, CDAB (W2W1), BADC
- **Function** modbus 0x03 or 0x04
- Read value converted to the chosen Ijinus datatype.
- Possible linear conversion of the value: Value = A * (X + B) + C
- Button to test the command in expert mode.

Write to register

Read register commands are limited to 8 maximum.

To add a register entry, click .

Write Modbus register

name

Address

Format

Byte order

Function Code

Value to write (decimal)

CANCEL

OK

- **Format** of written data: Unsigned16, Signed16, Unsigned32, Signed32, Float
- **Byte order** possible depending on the format: AB, BA, ABCD (W1W2), DCBA, CDAB (W2W1), BADC
- **Function** modbus 0x06 or 0x10
- **Value to write** : Write a constant to the target register

Add a delay

Delay commands are limited to 8 maximum.

- To add a delay between two commands, click  and enter a delay in ms.

Configuration summary

To view the configuration summary:

- Click [SEE OVERVIEW](#) to display a summary of the configuration.

Depending on the selected settings, the remaining recording time before the memory is full is given as well as an average of the number of SMS sent per day.

Modbus master
⌵

Data recording every **15 mins**

Modbus commands : **1 Read / 1 Write**

Slave address : 1 (9600 bps 8 N 1)

Power the external probe (25ms)

Record : Debug (positive integer value)

[EDIT](#)

9.6.18. Measurement using the Modbus protocol : Slave mode

Principle

The Modbus protocol can be used to link the logger to a PLC in order to send measured data. In this case, the logger is in "Modbus slave" mode. This option is not available if the Modbus connection is used in slave mode only ("Modbus flowmeter"). This is because the logger has only one Modbus connection, which can be used either as a Modbus master or as a Modbus slave, but it is not possible to use both connections at the same time.



As Modbus communication is based on a notion of requests and responses, it is essential that the logger remains permanently switched on in Modbus slave mode, and consequently the use of an external power supply is necessary. (See [Using a power pack](#) or ???).

Settings



Prerequisite: In Avelour, the Wiji connection with the logger must be established, see [Connecting to a logger](#).

- Click on the  button to add a configuration measurement and select "Modbus output".



It is essential that these parameters coincide perfectly with the ones expected by the PLC connected to the logger.

Modbus output ✖

Modbus configuration

Slave address	- 1 +	Mode	RTU -
Baudrate	19200 -	Data bits	8 -
Parity	Aucun -	Stop bits	1 -

Data registers

? Registers table
[More informations here](#) ✖

Type of application Industry / farming -

VIEW RESUME

Viewing data logs

A document can be displayed by clicking on the "More information here" link. This document, called "Modbus Tables", describes the address, offset, size and encoding (integer, inverted integer, etc.) for each item of data measured by an Ijinus logger.

Depending on the type of application chosen from the drop-down menu shown below, the table applied (and therefore the data encoding) will not be the same. It is therefore essential to use the correct register table to be able to send the desired measurements to the PLC via the Modbus protocol.

Configuration summary

- Click on the "View resume" button to display the summary of the recording configuration.

Depending on the settings selected, the remaining recording time before the memory is full is given as well as an average of the number of sms sent per day.

Modbus output 

Modbus hub **configured, Industry / farming** profile

- Slave address = **1**
- Modbus **RTU**
- **19200** Baud
- **8** data bits
- **None** parity
- **1** stop bit(s)

Caution ! This application needs an external power supply between 8 and 30 V (wiring pins 1,2 = V+,GND)

EDIT

9.6.19. Measurement via DI/CO input

Principle

The Contact/Counter input 1-100 is used to detect the closure of a contact on one of the logger's digital inputs, and to record it with the timestamp of the change of state.

Configuration



Prerequisites: In Avelour, the Wiji connection to the logger must be established, see [Connecting to a logger](#).

- Click  to add a measurement configuration and select "DI/CO input".



Each change of state is time-stamped. Furthermore, the state of the input will be measured every hour by default.

- Click  to disable hourly state recording.

A change of state can also be detected and recorded on a second channel.

Fifo memory

By default, when the logger's memory is full, data is deleted in chronological order of recording, from oldest to most recent.

- If Fifo memory is disabled, define a maximum number of timestamps.

Maximum records SMS Maximum records

Configuration summary

To view the configuration summary:

- Click  to display a summary of the configuration.



Mapping table between DataID, channel & data

DataId	Channel	Data displayed	Units	Data Description	Data files
0	0	State	-	DI 1 status	*_di1.bin

DataId	Channel	Data displayed	Units	Data Description	Data files
0	1	State	-	DI 2 status	*_di2.bin
3	7	Debug (signed integer value)	mAh	Internal battery current consumption	*_diag.bin
6	0	Voltage	V	Instantaneous internal battery voltage (Res. 0.05 V)	*_diag.bin
6	1	Voltage	V	Minimum internal battery voltage reached (Res. 0.05 V)	*_diag.bin
17	0	GSM signal Power	dBm	GSM signal power	*_diag.bin
19	0	Date	-	POSIX time	Asynchronous data

9.6.20. Modbus flow meter

Principle

The "Modbus flowmeter" measurement configuration enables data to be recorded using a flowmeter via Modbus communication, slave mode.

Flowmeter wiring



For correct operation of the flowmeter in MODBUS mode, you need to connect the ground wire. (See paragraph [Wiring](#).)

Configuration



Prerequisites: In Avelour, the Wiji connection to the logger must be established, see [Connecting to a logger](#).

- Click  to add a measurement configuration and select "Modbus Flowmeter".

- Select the **Recording period** corresponding to the time between each recording (every 15 minutes for example).
- Select the type of **flow meter** connected to the logger.



List of selectable flowmeters

- Activate if necessary recording of **volume, flow, pressure, temperature, battery capacity** And **direction** parameters.

MODBUS parameter

ABB - AQUAMASTER4

Baudrate : 19200, Bit number : 8, Parity : Even, Stop bit : 1

For wiring, refer to the paragraph [???](#)

ARAD - OCTAVE

Baudrate : 9600, Bit number : 8, Parity : Even, Stop bit : 1

For wiring, refer to the paragraph [la section intitulée « Octave »](#)

ENLESS+HAUSER - PROMAG W800

Baudrate : 9600, Bit number : 8, Parity : Even, Stop bit : 1

For wiring, refer to the paragraph [la section intitulée « Octave »](#)

FUJI ELECTRIC - M5000

Baudrate : 9600, Bit number : 8, Parity : Even, Stop bit : 1

For wiring, refer to the paragraph [_M5000](#)

KROHNE - WATERFLUX 3070

Baudrate : 9600, Bit number : 8, Parity : Even, Stop bit : 1

For wiring, refer to the paragraph [_3070](#)

SIEMENS - MAG 8000

Baudrate : 19200, Bit number : 8, Parity : Even, Stop bit : 1

For wiring, refer to the paragraph [_MAG8000](#)

Modbus slave ID (Advanced parameter)

To enter the Modbus slave ID:

- Click  to display advanced settings.

ID esclave ModBus

Flow calculation

If an hourly flow is activated then it is possible to calculate this hourly volume.

- Enter start and end times.
- Activate if necessary the type of calculation recorded: an **average**, a **minimum** flow rate and/or a **maximum** flow rate.



Check sensor operation

- Click  to view measured values.
-> Connection to the device is initiated and a new window displays the measured values.

Fifo memory

By default, when the logger's memory is full, data is deleted in chronological order of recording, from oldest to most recent.

- If Fifo memory is disabled, define a maximum number of timestamps.



Configuration summary

To view the configuration summary:

- Click on [SEE OVERVIEW](#) to display a summary of the configuration.



Table of datatype correspondences

This file contains, for each brand of flow meter, the correspondence between the type of data recorded (volume, flow rate, pressure, etc.) and the number encoded by the Ijinus logger (datatype). As several identical types of data can be recorded, a channel number is also added to the datatype.

MAG 8000

Displayed Data	DatalD	Channel	Unités	Description	Data Files
Modbus register	21	20	-	Fault status	*_mag8000.bin
Modbus register	21	21	-	Configuration	*_mag8000.bin
Velocity	24	20	mm/s	Velocity	*_mag8000.bin
Flow rate	34	20	m³/s	Flow rate	*_mag8000.bin
Volume	39	20	m³	Forward volume 1	*_mag8000.bin
Volume	39	21	m³	Reverse volume 2	*_mag8000.bin
Volume	39	22	m³	Forward volume 2	*_mag8000.bin
Volume	39	24	m³	Total volume 1	*_mag8000.bin

Debug (signed integer value)	3	20	m ³	Forward volume 1 (integer m ³)	*_mag8000.bin
Debug (signed integer value)	3	21	m ³	Reverse volume 1 (integer m ³)	*_mag8000.bin
Debug (signed integer value)	3	22	m ³	Forward volume 2 (integer m ³)	*_mag8000.bin
Debug (signed integer value)	3	24	m ³	Total volume 1 (integer m ³)	*_mag8000.bin
Debug (positive integer value)	2	22	%	Flowmeter battery charge state	*_mag8000.bin
Counter	22	26	-	Hour of minimum night flow rate	*_min-fm.bin
Counter	22	27	-	Hour of maximal night flow rate	*_max-fm.bin
Volume	39	25	m ³	Hourly volume	*_hourlyflow-fm.bin
Volume	39	26	m ³	Minimum night flow rate	*_min-fm.bin
Volume	39	27	m ³	Maximum night flow rate	*_max-fm.bin
Volume	39	28	m ³	Average flow rate	*_moy-fm.bin
Volume	39	30	m ³	24-hour volume	*_dailyflow-fm.bin
Volume	39	31	m ³	Weekly volume	*_weeklyflow-fm.bin
Volume	39	32	m ³	Monthly volume	*_monthlyflow-fm.bin
State	0	20	-	Threshold state change	*_thres-event-fm.bin
Debug (signed integer value)	3	7	mAh	Internal battery current capacity consumption	*_diag.bin
GSM signal Power	17	0	dBm	GSM signal power	*_diag.bin
Voltage	6	0	V	Instantaneous battery voltage (Res. 0.05 V)	*_diag.bin
Voltage	6	1	V	Minimum battery voltage reached (Res. 0.05 V)	*_diag.bin

Waterflux 3070

Displayed Data	DataID	Channel	Unités	Description	Data Files
Debug (positive integer value)	2	20	-	Flow direction	*_waterflux.bin

Debug (positive integer value)	2	21	-	Alarms	*_waterflux.bin
Debug (Real value)	4	20	Ah	Remaining flowmeter battery capacity	*_waterflux.bin
Temperature	12	20	°C	Liquide temperature (Res. 0.1 °C)	*_waterflux.bin
Velocity	24	20	mm/s	Velocity	*_waterflux.bin
Flow rate	34	20	m ³ /s	Flow rate	*_waterflux.bin
Pressure	37	20	bar	Liquid pressure	*_waterflux.bin
Volume	39	20	m ³	Forward volume	*_waterflux.bin
Volume	39	21	m ³	Reverse volume	*_waterflux.bin
Volume	39	24	m ³	Total volume	*_waterflux.bin
Counter	22	26	-	Hour of minimum night flow rate	*_min-fm.bin
Counter	22	27	-	Hour of maximal night flow rate	*_max-fm.bin
Volume	39	25	m ³	Hourly volume	*_hourlyflow-fm.bin
Volume	39	26	m ³	Minimum night flow rate	*_min-fm.bin
Volume	39	27	m ³	Maximum night flow rate	*_max-fm.bin
Volume	39	28	m ³	Average flow rate	*_moy-fm.bin
Volume	39	30	m ³	24-hour volume	*_dailyflow-fm.bin
Volume	39	31	m ³	Weekly volume	*_weeklyflow-fm.bin
Volume	39	32	m ³	Monthly volume	*_monthlyflow-fm.bin
State	0	20	-	Threshold state change	*_thres-event-fm.bin
Debug (signed integer value)	3	7	mAh	Internal battery current capacity consumption	*_diag.bin
GSM signal Power	17	0	dBm	GSM signal power	*_diag.bin
Voltage	6	0	V	Instantaneous battery voltage (Res. 0.05 V)	*_diag.bin
Voltage	6	1	V	Minimum battery voltage reached (Res. 0.05 V)	*_diag.bin

M5000

Displayed Data	DataID	Channel	Unités	Description	Data Files
Modbus register	21	20	-	Fault	*_m5000.bin
Modbus register	21	21	-	Flow direction	*_m5000.bin
Velocity	24	20	mm/s	Velocity	*_m5000.bin
Flow rate	34	20	m ³ /s	Flow rate	*_m5000.bin
Volume	39	20	m ³	Forward volume 1	*_m5000.bin
Volume	39	21	m ³	Reverse volume 1	*_m5000.bin
Volume	39	22	m ³	Forward volume 2	*_m5000.bin
Volume	39	23	m ³	Reverse volume 2	*_m5000.bin
Volume	39	24	m ³	Total volume	*_m5000.bin
Counter	22	26	-	Hour of minimum night flow rate	*_min-fm.bin
Counter	22	27	-	Hour of maximal night flow rate	*_max-fm.bin
Volume	39	25	m ³	Hourly volume	*_hourlyflow-fm.bin
Volume	39	26	m ³	Minimum night flow rate	*_min-fm.bin
Volume	39	27	m ³	Maximum night flow rate	*_max-fm.bin
Volume	39	28	m ³	Average flow rate	*_moy-fm.bin
Volume	39	30	m ³	24-hour volume	*_dailyflow-fm.bin
Volume	39	31	m ³	Weekly volume	*_weeklyflow-fm.bin
Volume	39	32	m ³	Monthly volume	*_monthlyflow-fm.bin
State	0	20	-	Threshold state change	*_thres-event-fm.bin
Debug (signed integer value)	3	7	mAh	Internal battery current capacity consumption	*_diag.bin
GSM signal Power	17	0	dBm	GSM signal power	*_diag.bin
Voltage	6	0	V	Instantaneous battery voltage (Res. 0.05 V)	*_diag.bin
Voltage	6	1	V	Minimum battery voltage reached (Res. 0.05 V)	*_diag.bin

PROMAG w 800

Displayed Data	DataID	Channel	Unités	Description	Data Files
----------------	--------	---------	--------	-------------	------------

Debug (positive integer value)	2	20	%	Flowmeter battery charge state	*_promag.bin
Debug (positive integer value)	2	21	days	Estimated flowmeter battery lifetime	*_promag.bin
Velocity	24	20	mm/s	Velocity	*_promag.bin
Conductivity	26	20	µS/cm	Conductivity	*_promag.bin
Flow rate	34	20	m³/s	Flow rate	*_promag.bin
Volume	39	20	m³	Forward volume	*_promag.bin
Volume	39	21	m³	Reverse volume	*_promag.bin
Volume	39	24	m³	Total volume	*_promag.bin
Counter	22	26	-	Hour of minimum night flow rate	*_min-fm.bin
Counter	22	27	-	Hour of maximal night flow rate	*_max-fm.bin
Volume	39	25	m³	Hourly volume	*_hourlyflow-fm.bin
Volume	39	26	m³	Minimum night flow rate	*_min-fm.bin
Volume	39	27	m³	Maximum night flow rate	*_max-fm.bin
Volume	39	28	m³	Average flow rate	*_moy-fm.bin
Volume	39	30	m³	24-hour volume	*_dailyflow-fm.bin
Volume	39	31	m³	Weekly volume	*_weeklyflow-fm.bin
Volume	39	32	m³	Monthly volume	*_monthlyflow-fm.bin
State	0	20	-	Threshold state change	*_thres-event-fm.bin
Debug (signed integer value)	3	7	mAh	Internal battery current capacity consumption	*_diag.bin
GSM signal Power	17	0	dBm	GSM signal power	*_diag.bin
Voltage	6	0	V	Instantaneous battery voltage (Res. 0.05 V)	*_diag.bin
Voltage	6	1	V	Minimum battery voltage reached (Res. 0.05 V)	*_diag.bin

Octave

Displayed Data	DataID	Channel	Unités	Description	Data Files
----------------	--------	---------	--------	-------------	------------

Debug (positive integer value)	2	20	-	Flow direction	*_octave.bin
Temperature	12	20	°C	Liquid temperature (Res. 0.1 °C)	*_octave.bin
Modbus Register	21	20	-	Alarms	*_octave.bin
Flow rate	34	20	m ³ /s	Flow rate	*_octave.bin
Volume	39	20	m ³	Reverse volume 1	*_octave.bin
Volume	39	21	m ³	Forward volume 2	*_octave.bin
Volume	39	24	m ³	Total volume	*_octave.bin
Counter	22	26	-	Hour of minimum night flow rate	*_min-fm.bin
Counter	22	27	-	Hour of maximal night flow rate	*_max-fm.bin
Volume	39	25	m ³	Hourly volume	*_hourlyflow-fm.bin
Volume	39	26	m ³	Minimum night flow rate	*_min-fm.bin
Volume	39	27	m ³	Maximum night flow rate	*_max-fm.bin
Volume	39	28	m ³	Average flow rate	*_moy-fm.bin
Volume	39	30	m ³	24-hour volume	*_dailyflow-fm.bin
Volume	39	31	m ³	Weekly volume	*_weeklyflow-fm.bin
Volume	39	32	m ³	Monthly volume	*_monthlyflow-fm.bin
State	0	20	-	Threshold state change	*_thres-event-fm.bin
Debug (signed integer value)	3	7	mAh	Internal battery current capacity consumption	*_diag.bin
GSM signal Power	17	0	dBm	GSM signal power	*_diag.bin
Voltage	6	0	V	Instantaneous battery voltage (Res. 0.05 V)	*_diag.bin
Voltage	6	1	V	Minimum battery voltage reached (Res. 0.05 V)	*_diag.bin

Aquamaster

Displayed Data	DataID	Channel	Unités	Description	Data Files
Modbus register	21	20	-	Alarms	*_aqua.bin
Velocity	24	20	mm/s	Velocity	*_aqua.bin
Flow rate	34	20	m ³ /s	Flow rate	*_aqua.bin

Pressure	37	20	bar	Liquid pressure	*_aqua.bin
Volume	39	20	m ³	Forward volume	*_aqua.bin
Volume	39	21	m ³	Reverse volume	*_aqua.bin
Volume	39	24	m ³	Total volume	*_aqua.bin
Counter	22	26	-	Hour of minimum night flow rate	*_min-fm.bin
Counter	22	27	-	Hour of maximal night flow rate	*_max-fm.bin
Volume	39	25	m ³	Hourly volume	*_hourlyflow-fm.bin
Volume	39	26	m ³	Minimum night flow rate	*_min-fm.bin
Volume	39	27	m ³	Maximum night flow rate	*_max-fm.bin
Volume	39	28	m ³	Average flow rate	*_moy-fm.bin
Volume	39	30	m ³	24-hour volume	*_dailyflow-fm.bin
Volume	39	31	m ³	Weekly volume	*_weeklyflow-fm.bin
Volume	39	32	m ³	Monthly volume	*_monthlyflow-fm.bin
State	0	20	-	Threshold state change	*_thres-event-fm.bin
Debug (signed integer value)	3	7	mAh	Internal battery current capacity consumption	*_diag.bin
GSM signal Power	17	0	dBm	GSM signal power	*_diag.bin
Voltage	6	0	V	Instantaneous battery voltage (Res. 0.05 V)	*_diag.bin
Voltage	6	1	V	Minimum battery voltage reached (Res. 0.05 V)	*_diag.bin

9.6.21. Recording of bucket toggles

Principle

This configuration allows you to time-stamp each time a bucket tips on a rain gauge connected to the logger.

Numerous tipping bucket rain gauges of different brands can be connected, provided they are equipped with an output signal based on the closure of a "normally open" contact with a minimum duration of 150 ms in the down state each time the buckets are tipped.

Configuration



Prerequisites: In Avelour, the Wiji connection to the logger must be established, see [Connecting to a logger-parameters](#).

- Click  to add a measurement configuration and select "Timestamp bucket tips".



Fifo Memory (Advanced Setting)

By default, when the logger memory is full, data are deleted in chronological order of recording, from oldest to newest.

- Click  to display advanced settings.
- If Fifo memory is disabled, change the maximum number of timestamps for the main memory (used for sending data via Internet) and the auxiliary memory (used for sending data via SMS) if necessary.

Maximum records SMS Maximum records

Configuration summary

To view the configuration summary:

- Click  to display a summary of the configuration.



Recording of bucket toggles

Datald	Channel	Data displayed	Units	Data Description	Data files
3	7	Debug (signed integer value)	mAh	Internal battery current consumption	*_diag.bin

DataId	Channel	Data displayed	Units	Data Description	Data files
6	0	Voltage	V	Instantaneous internal battery voltage (Res. 0.05 V)	*_diag.bin
6	1	Voltage	V	Minimum internal battery voltage reached (Res. 0.05 V)	*_diag.bin
6	2	Voltage	V	Instantaneous external battery voltage (Res. 0.05 V)	*_extbat.bin
17	0	GSM signal Power	dBm	GSM signal power	*_diag.bin
19	0	Date	-	POSIX time	Asynchronous data
22	0	Counter	-	Recording of bucket toggles	*_toggle.bin

9.6.22. Cumulative Rainfall

Principle

The purpose of this application is to be able to use a rain gauge connected to an Ijinus logger with a digital input. It is possible to connect many different brands of tipping bucket rain gauges provided that it is equipped with an output signal based on the closure of a "normally open" contact for a minimum duration of 150 ms in low state each time the bucket tips.

The logger must be connected to the rain gauge to install using the cable provided. The part fitted with a connector must be inserted into the logger connector.

For rain gauges not supplied by Ijinus, refer to the chapter [M12 8-pin connector](#).

Configuration



Prerequisites: In Avelour, the Wiji connection to the logger must be established, see [Connecting to a logger](#).

- Click  to add a measurement configuration and select "Rainfall measurement".

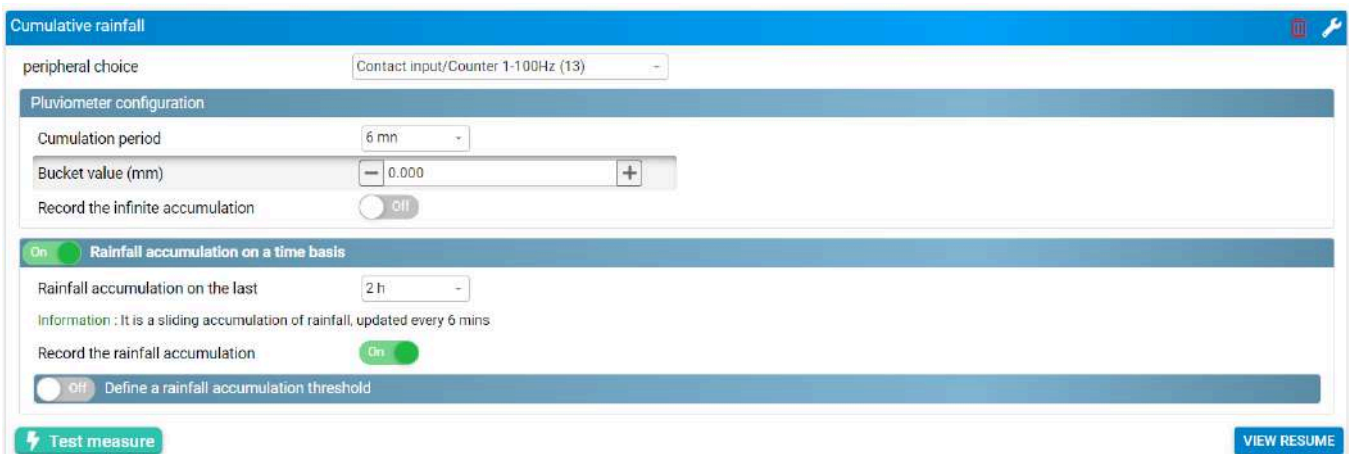

Peripheral choice

- Define the input path (see [Wiring](#)).

Rain gauge configuration

Value of the bucket

Depending on the model of rain gauge connected to the logger, the weight of the bucket may be different.

Rain gauge model	Weight of bucket
RG20	0.2 mm
RG25	0.254 mm

Rainfall accumulation on a time basis

- Select the frequency of sliding cumulative rainfall recordings.

Configuration summary

To view the configuration summary:

- Click [SEE OVERVIEW](#) to display a summary of the configuration.

Depending on the selected settings, the remaining recording time before the memory is full is shown, as well as an average of the number of SMS text messages sent per day.

Cumulative rainfall

Rainfall recording every **6 mins**, with a bucket value of **0 mm**
 Recording of **Rainfall accumulation** on the last **2 hrs**
 Recording will last for about 6 mths / Send around 4.8 SMS each day

⚡ Test measure
EDIT

Mapping table between DataID, channel & data

The table below shows the correspondence for the two DI meters between the type of data recorded (volume, flow, pressure, etc.) and the number encoded by the Ijinus logger (datatype). As several identical types of data can be recorded, a channel number is also added to the datatype.

DataId	Channel	Data displayed	Units	Data Description	Data files
0	0	State	-	Threshold event on cumulative precipitation	*_event.bin
3	7	Debug (signed integer value)	mAh	Internal battery current consumption	*_diag.bin
6	0	Voltage	V	Instantaneous internal battery voltage (Res. 0.05 V)	*_diag.bin
6	1	Voltage	V	Minimum internal battery voltage reached (Res. 0.05 V)	*_diag.bin
17	0	GSM signal Power	dBm	GSM signal power	*_diag.bin
19	0	Date	-	POSIX time	Asynchronous data
22	0	Counter	-	Infinite counting of the number of tray flips	*_rain.bin
35	0	Cumul de pluviométrie	mm	Cumulated total precipitation over the cumulation period	*_rain.bin

9.6.23. Measurement for pump station management

Principle

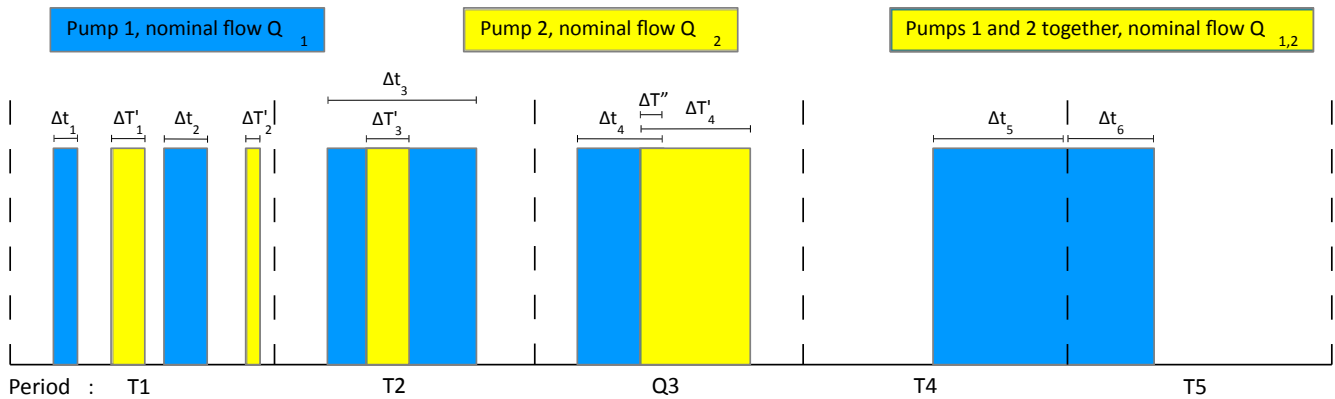

Overview	Number of P1 starts	Number of P2 starts	Number of times P1 and P2 worked together	P1 operating time	P2 operating time	Combined operating time of P1 and P2
Period	'counter[0]'	'counter[1]'	'counter[2]'	'duration[0]' (sec)	'duration[1]' (sec)	'duration[2]' (sec)
T1	2	2	0	$\Delta t_1 + \Delta t_2$	$\Delta t'_1 + \Delta t'_2$	0
T2	1	1	1	Δt_3	$\Delta t'_3$	$\Delta t'_3$
T3	1	1	1	Δt_4	$\Delta t'_4$	$\Delta t''$
T4	1	0	0	Δt_5	0	0
T5	0	0	0	Δt_6	0	0

Review	Volume transited at flow rate Q_1 (P1 only)	Volume transited at flow rate Q_2 (P2 only)	Volume transited at flow rate $Q_{1,2}$ (P1 and P2 combined)	Total volume transited through the station
Period	'volume[0]' (m ³)	'volume[1]' (m ³)	'volume[2]' (m ³)	'volume[3]' (m ³)
T1	$(\Delta t_1 + \Delta t_2) \cdot Q_1$	$(\Delta t'_1 + \Delta t'_2) \cdot Q_2$	0	volume[0]
T2	$(\Delta t_3 + \Delta t'_3) \cdot Q_1$	0	$\Delta t'_3 \cdot Q_{1,2}$	+
T3	$(\Delta t_4 + \Delta t'') \cdot Q_1$	$(\Delta t'_4 + \Delta t'') \cdot Q_2$	$\Delta t'' \cdot Q_{1,2}$	volume[1]
T4	$\Delta t_5 Q_1$	0	0	+
T5	$\Delta t_6 Q_1$	0	0	volume[2]

Configuration

For more information on managing a pump station with flow calculation on two pumps, a .pdf file is available by clicking on "more information about functioning".

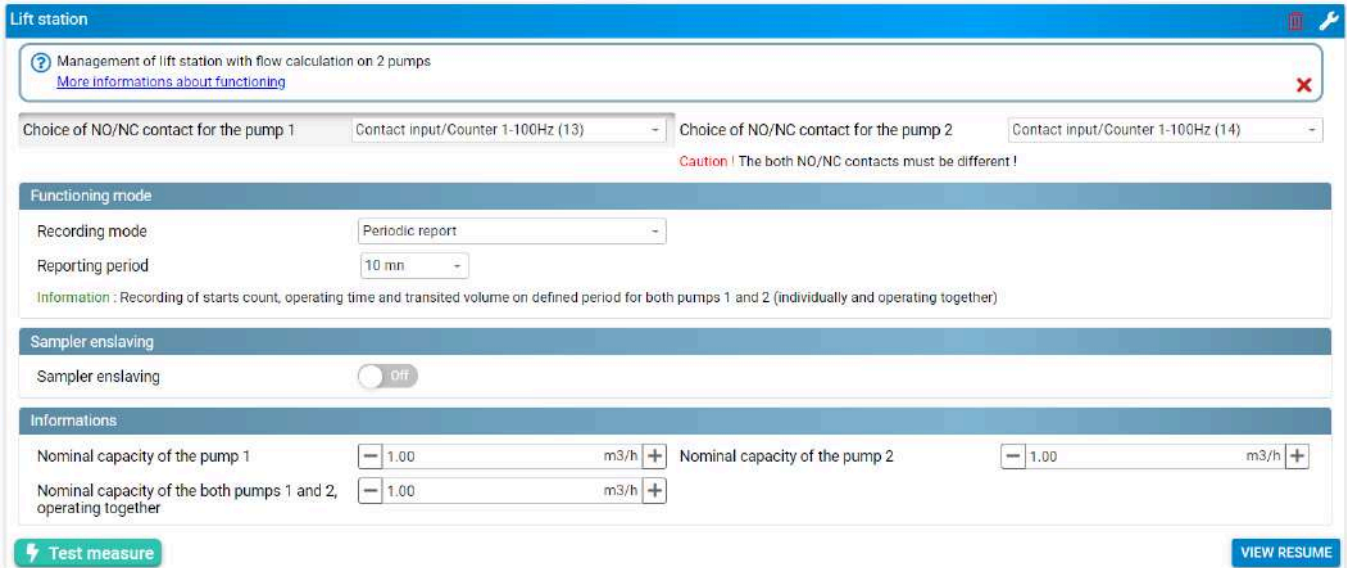

Contact selection



The two digital contacts must be different!

Functioning mode

Recording mode

- **Time-stamp pump 1 and 2 starts** : This mode records the date and time of pump 1 and 2 starts.
- **Reporting period** : This mode records the starts count, operating time and volume transited over the defined period for pumps 1 and 2 (individually + operating together).

Sampler enslaving

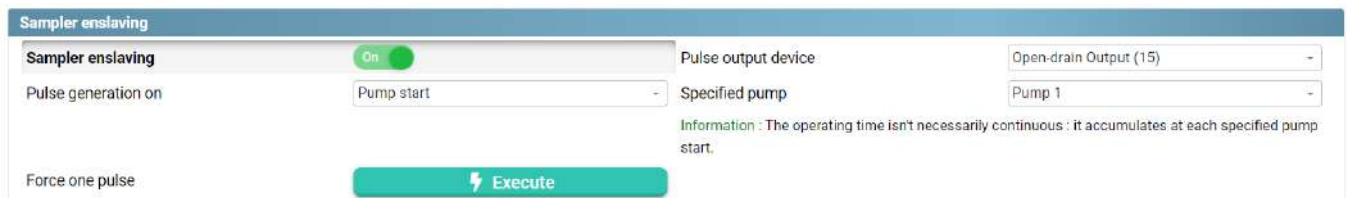

Pulse generation on pump start, pump operating time or volume transited in the pump station

Pulse output device choice of "Open-drain output" or "Direct external supply" voice (see [Wiring](#) paragraph)

Specified pump : Pump 1, Pump 2 or any pump.



Operating time is not necessarily continuous: it is accumulated each time the pump is activated.

Pulse duration (ms) : 500 ms by default

Sampler enslaving

Sampler enslaving: On

Pulse generation on: Operating time of pump

Specified pump: Pump 1

Information: The operating time isn't necessarily continuous.

Force one pulse: Whatever the pump

Pulse output device: Open-drain Output (15)

Operating time: 0 h 0 min 0 sec

Sampler enslaving

Sampler enslaving: On

Pulse generation on: Volume transited through the lift station

Force one pulse: Execute

Pulse output device: Open-drain Output (15)

Volume: - 0.00 m3 +

Information

- Enter nominal flow rates for pump 1, pump 2 and operating together.

Configuration summary

To view the configuration summary:

- Click [SEE OVERVIEW](#) to display a summary of the configuration.

Lift station

Recording mode: **Periodic report** every 10 mins

Sampler enslaving every 00:00:00 s operating time of : pump 1

Nominal capacity pump 1 = 1 m3/h, pump 2 = 1 m3/h, pumps 1 and 2 together = 1 m3/h

Recording will last for about 11 mths / Send around 11.5 SMS each day

Test measure [EDIT](#)

Mapping table between DataID, channel & data

DataId	Channel	Data displayed	Units	Data Description	Data files
0	0	State	-	Pump 1 status (0 : off / 1 : running / -1 : unchanged status)	*_pump1.bin, *_pumpDi-ag.bin
0	1	State	-	Pump 2 status (0 : off / 1 : running / -1 : unchanged status)	*_pump2.bin, *_pumpDi-ag.bin
3	7	Debug (signed integer value)	mAh	Internal battery current consumption	*_diag.bin
6	0	Voltage	V	Instantaneous internal battery voltage (Res. 0.05 V)	*_diag.bin
6	1	Voltage	V	Minimum internal battery voltage reached (Res. 0.05 V)	*_diag.bin

DataId	Channel	Data displayed	Units	Data Description	Data files
17	0	GSM signal Power	dBm	GSM signal power	*_diag.bin
19	0	Date	-	POSIX time	Asynchronous data
22	0	Counter	-	Number of starts of pump 1 for the defined period	*_pumpReport.bin
22	1	Counter	-	Number of starts of pump 2 for the defined period	*_pumpReport.bin
22	2	Counter	-	Number of times pumps 1 and 2 operated together during the defined period	*_pumpReport.bin
39	0	Volume	m ³	Volume that has passed through pump 1 only for the defined period	*_pumpReport.bin
39	1	Volume	m ³	Volume that has passed through pump 2 only for the defined period	*_pumpReport.bin
39	2	Volume	m ³	Volume that has passed through pumps 1 and 2 operating together for the defined period	*_pumpReport.bin
39	3	Volume	m ³	Volume that passed through the station during the defined period	*_pumpReport.bin
40	0	Duration	s	Operating time of pump 1 for the defined period	*_pumpReport.bin
40	1	Duration	s	Operating time of pump 2 for the defined period	*_pumpReport.bin
40	2	Duration	s	Operating time of pump 1 and 2 together for the defined period	*_pumpReport.bin

9.6.24. Flow measurement using a 100 Hz velocity counter

Principle

This configuration is used to record pulses from a flowmeter.

Configuration



Prerequisites: In Avelour, the Wiji connection to the logger must be established (see [Connecting to a logger](#)).

In the logger configuration window:

- Click  to add a measurement and select "100 Hz velocity counter".

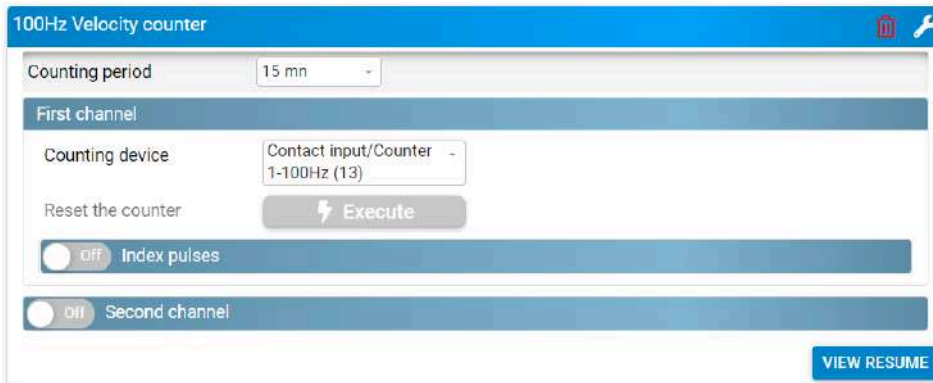



100 Hz velocity counter parameters

Counting period

The counting period is the length of time during which the pulses received will be accumulated.

First channel

- Select the counting device. (refer to [Wiring](#)).
- Click on the  "Reset the counter" button to reset the pulse counter to 0.
- To save accumulated pulses without resetting, click  to display the advanced settings and activate  **Infinite index recording**.

Indexing pulses

- Activate  the **index pulses** option to convert the pulses sent by the flowmeter into a volume and therefore a flow rate.
- Enter the **weight** of each pulse, as configured in the flowmeter.
- Select the **index unit**: mm, m³Tonne or Watt.
- Enter the **initial index** reflecting the initial state before the start of measurement.

- Activate **Infinite index recording** to save the total number of indexes counted.
- If the unit is m^3 , activate **average flow recording**, if required.

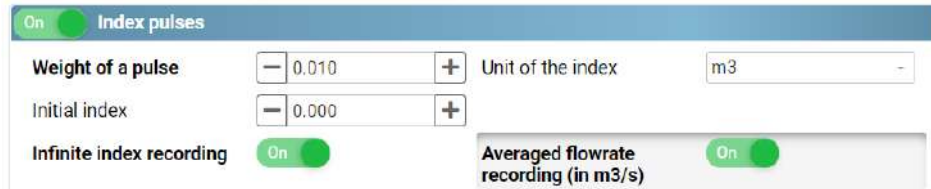

Flowmeter set to send one pulse each time a volume of $0.01 m^3$ is measured.

Sampler enslaving



This option is rarely used for drinking water network diagnostics. However, as this functionality is common to all sanitation range loggers, the possibility of slave control of a sampler is presented below.

If the pulses sent by the flowmeter have been converted to a volume, it is possible to control a sampler via the logger's open-drain output. In the example below, the logger sends a pulse to the sampler each time it calculates that a volume of 1 cubic meter has passed through the flowmeter.

Example: the logger is in standby mode between two measurements. This means that if the measurement period is 15 minutes, no pulses will be sent to the sampler between two periods. For example, if the logger has received 1000 pulses from the flowmeter over 15 minutes (i.e. 10 cubic meters according to the above example), then 10 pulses in a row will be sent to the sampler after 15 minutes.



Check the wiring between the logger and the sampler

- Click the  button to send a single pulse to the sampler to verify that the wiring between the logger and the sampler is correct.

Flow calculation

It is possible to calculate an **hourly flow rate** from pulse data sent by the flowmeter.

If an hourly flow rate is calculated, then it is possible to perform calculations on this hourly volume. In particular, you can activate calculate average flow, minimum flow and/or maximum flow over a given period.



Fifo Memory (Advanced Setting)

By default, when the logger memory is full, data are deleted in chronological order of recording, from oldest to newest.

- Click  to display advanced settings.
- If Fifo memory is disabled, change the maximum number of timestamps for the main memory (used for sending data via Internet) and the auxiliary memory (used for sending data via SMS) if necessary.

Maximum records SMS Maximum records

Configuration summary

To view the configuration summary:

- Click [SEE OVERVIEW](#) to display a summary of the configuration.

Depending on the settings selected, the remaining recording time before the memory is full is shown, as well as an average of the number of text messages sent per day.

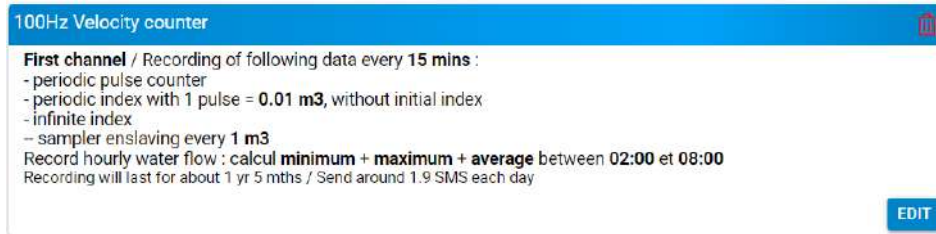

Mapping table between DataID, channel & data

The table below shows the correspondence for the two DI meters between the type of data recorded (volume, flow, pressure, etc.) and the number encoded by the Ijinus logger (datatype). As several identical types of data can be recorded, a channel number is also added to the datatype.

Datald	Channel	Data displayed	Units	Data Description	Data files
3	7	Debug (signed integer value)	mAh	Internal battery current consumption	*_diag.bin
6	0	Voltage	V	Instantaneous internal battery voltage (Res. 0.05 V)	*_diag.bin
6	1	Voltage	V	Minimum internal battery voltage reached (Res. 0.05 V)	*_diag.bin
17	0	GSM signal Power	dBm	GSM signal power	*_diag.bin
19	0	Date	-	POSIX time	Asynchronous data
22	0	Counter	-	Counter value of the first channel for the counting period	*_histocnt1.bin

DataId	Channel	Data displayed	Units	Data Description	Data files
22	1	Counter	-	Infinite pulse counter for the first channel	*_cnt1.bin
22	2	Counter	-	Counter value of the second channel for the counting period	*_histocnt2.bin
22	3	Counter	-	Infinite pulse counter for the second channel	*_cnt2.bin
22	6	Counter	-	Time (hour) corresponding to the minimum night hourly flow rate for the first channel	*_Min.bin
22	7	Counter	-	Time (hour) corresponding to the maximum night hourly flow rate for the first channel	*_Max.bin
22	9	Counter	-	Time (hour) corresponding to the minimum night hourly flow rate for the second channel	*_Min-2.bin
22	10	Counter	-	Time (hour) corresponding to the maximum night hourly flow rate for the second channel	*_Max-2.bin
34	0	Flow rate	m ³ /s	Average flow rate for the first channel for the counting period	*_cnt1.bin
34	1	Flow rate	m ³ /s	Average flow rate for the second channel for the counting period	*_cnt2.bin
39	4	Volume	m ³	Hourly flow for the first channel	*_index.bin
39	5	Volume	m ³	Hourly flow for the second channel	*_index-2.bin
39	6	Volume	m ³	Minimum night hourly flow for the first channel	*_Min.bin

Datald	Channel	Data displayed	Units	Data Description	Data files
39	7	Volume	m ³	Maximum night hourly flow for the first channel	*_Max.bin
39	8	Volume	m ³	Average night hourly flow for the first channel	*_Moy.bin
39	9	Volume	m ³	Minimum night hourly flow for the second channel	*_Min-2.bin
39	10	Volume	m ³	Maximum night hourly flow for the second channel	*_Max-2.bin
39	11	Volume	m ³	Average night hourly flow for the second channel	*_Moy-2.bin
15/39/42/43	0	Material height/ Volume/Weight/ Wattage	mm/m ³ /t/W	Converted value for the first channel	*_histocnt1.bin
15/39/42/43	1	Material height/ Volume/Weight/ Wattage	mm/m ³ /t/W	Total converted value for the first channel	*_cnt1.bin
15/39/42/43	2	Material height/ Volume/Weight/ Wattage	mm/m ³ /t/W	Converted value for the second channel	*_histocnt2.bin
15/39/42/43	3	Material height/ Volume/Weight/ Wattage	mm/m ³ /t/W	Total converted value for the first channel	*_cnt2.bin

9.7. Configuring the sending data

9.7.1. Technologies used

Different methods of data transmission are possible, such as SMS messages or Internet communication using FTP(s), HTTP(s) or CoAP protocols. For this, several technologies can be used: 2G, 3G, LTE-M, NB-IoT and MQTT(s).

The use of a communication PCB is possible to transmit data over LoRaWAN.



NB-IoT technology does not allow data to be sent by SMS.

A very important factor in data transmission is the quality of the telephone operator's signal at the location where the logger is installed. Depending on how the logger is installed, signal quality may be degraded, for example if the logger is placed in a manhole closed by a metal cover.



The quality of the signal during data transmission has an impact on the logger's battery life. Indeed, the poorer the signal quality, the higher the energy consumption needed for transmission.

9.7.2. Signal quality: Mobile Signal Strength Value

Signal strength (dBm)	Signal quality
+ 49 dBm	Default value that may indicate a network connection problem
- 70 to -80 dBm	Very good quality
- 80 to -90 dBm	Good quality
- 90 to -100 dBm	Average quality
- 100 to - 105 dBm	Poor signal quality
+ 113 dBm	No communication possible

9.7.3. Configuring the modem of the communication card



Prerequisites: A SIM card with a "voice" or SMS message package must be inserted into the holder. See paragraph [Inserting a SIM card](#) parameters.

Before being able to send data by SMS or M2M, you must configure the modem on the communication board.

- In the "Data sending" block, click "EDIT".

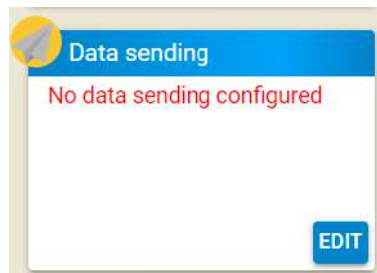

-> The data transmission parameter editing window is displayed.

Data sending
⚙️

Modem options

? The 'PINcode' and 'APN' fields **needs to be recorded in the modem chip.**
 Once you filled the fields, you have to **Click on the button** to record them in the modem chip and test the connection.

- The SIM code is specific to the SIM card and must be set if the SIM card is locked.
Beware, you have only 3 tries !
- The APN allows the modem to connect to the Internet and is specific to your phone operator.
 In the advanced parameters, you'll also find PPP parameters that could be needed by your operator.
- The PIN code and the APN are recorded directly in the modem chip and **can disappear** after a device reset even if they are still active in the modem chip.
 Also, **If you change the SIM card**, remember to set these fields

Technology to use:

PIN code: Inactive APN:

Use an external Antenna: Off

⚡ 1 : Program modem
⚡ 2 : Diagnostic modem

off Internet data sending

off SMS data sending

Alert parameters

Minimum time between two data sending: h min sec

off Send alert SMS

CLOSE

Technology to use

- Choose the technology used.

This could be 2G, 3G, LTE-M, or NB-IoT technology. For 3G, LTE-M and NB-IoT technologies, you can choose an option where 2G technology will be used as a backup if the selected technology is not available.



The selected technology must be compatible with the SIM card inserted in the logger and with the relay antennas located near the logger.

PIN code

- Enter a value in the field if the SIM card is protected by a PIN code.





Only 3 attempts are possible before the SIM card is blocked.

APN

- If the data is sent in M2M (by FTP (S) or CoAP), configure the APN of the SIM card. Hover the mouse over the question mark to display a list of the APN of some telephone operators.
- If a private APN with password is used, click on the icon  at the top right of the application to switch to advanced settings.

-> New options appear including fields, where necessary, to specify the username (PPP User) and the password (PPP Password).

- Activate the parameter to enter values in empty fields.

Technology to use	<input type="text" value="2G"/>	Priority operator 	<input type="checkbox"/> Inactive	<input type="text" value="20801"/>	<input type="text" value="+"/>
PIN code	<input type="checkbox"/> Inactive	<input type="text"/>	APN	<input type="text"/>	
PPP phone	<input type="checkbox"/> Inactive	<input type="text"/>	PPP user	<input type="checkbox"/> Inactive	<input type="text"/>
PPP password	<input type="checkbox"/> Inactive	<input type="text"/>	Use an external Antenna	<input type="checkbox"/> Off	
 1 : Program modem					
 2: Diagnostic modem					
Modem connection timeout	<input type="checkbox"/> Inactive	<input type="text" value="120"/>	<input type="text" value="-"/>	<input type="text" value="+"/>	

Priority operator (Multi-operator SIM)



This feature requires a firmware update (22.1 or later). Refer to paragraph [Firmware update](#).

This feature can only be used with a multi-operator SIM card.

In the case of a multi-operator SIM card, each time a data transmission occurs, a search for a connection to one of the available networks is launched randomly. If after 60 seconds, the attempt to connect to a network fails due to lack of signal strength, the SIM card then attempts to connect to another available network and therefore consumes electrical power.

To prevent the SIM card from attempting to connect to a network with excessively low signal strength, you can specify a priority operator network by entering its MCC + MDC code. (20820: Bouygues, 20801: Orange, 20810: SFR).

To define the priority operator, preferably the one with the highest signal strength at the measurement point, it is advisable to test the signal strength of all operators to determine which one to use in priority. To do this:

- Apply measurement conditions.
- Activate "Priority operator" and enter the operator code of the network to test. (20820: Bouygues, 20801: Orange, 20810: SFR)
- Click "Program modem".
- Click "Diagnostic Modem" and view the signal strength value. Refer to paragraph [Signal quality: Mobile Signal Strength Value](#) parameters.
- Repeat the procedure for all mobile network operators to determine the optimal operator for the measurement site.

Program modem

When the Modem parameters have been configured:

- Click on the button  "1: Program modem".



You must click the "1: Program modem" button to send data to the modem; simply saving the configuration does not allow you to configure the modem.



-> Programming the modem takes a few minutes. When the configuration is complete, a window opens to indicate the result:

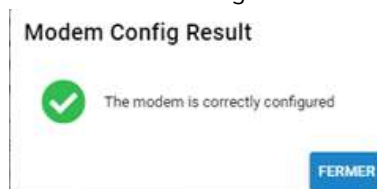

-> If the programming did not occur correctly, a window opens to indicate the problem encountered (SIM card absent, incorrect PIN code, etc.)

- Each time a parameter is modified (e.g. change of technology), click on the "1: Program modem" button.

9.7.4. Check network quality: Modem diagnostics

After setting up the Modem, you need to make sure that a communication network is available.

- Click the button "2: Modem diagnostic".

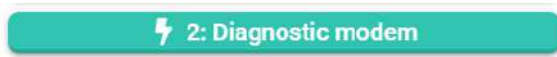

-> the communication PCB boots up and searches for a mobile network signal. A window opens to display the results

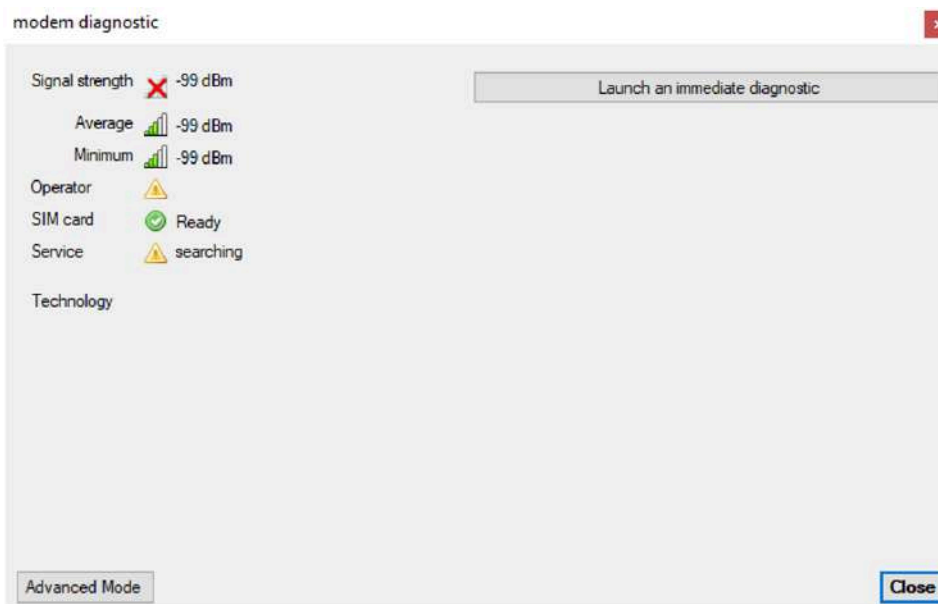

"Modem Status" window -

If the result is as shown above, it means that no signal has been located.

- Click the "Launch an immediate diagnostic" button to give the modem more time to detect a network. In less than a minute, a satisfactory result should appear as indicated below:

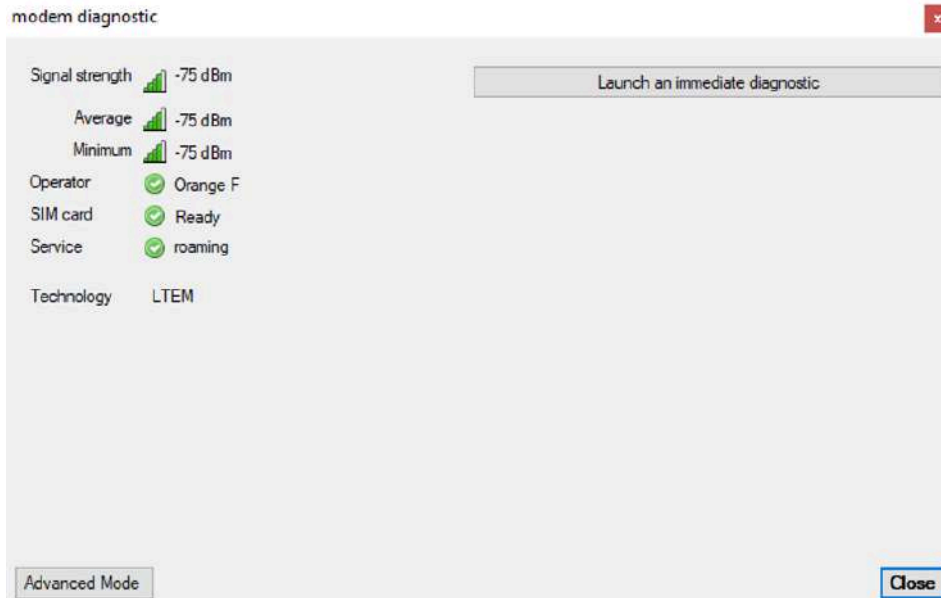

If after 5 minutes of searching the result is not satisfactory, it means that there is a problem with connecting to the network. Several cases are possible:

Problem	Corrective action
No network is available for the selected technology.	<ul style="list-style-type: none"> Select another communication technology if the SIM card allows it, then click on the "1: program modem" button
No network is available for the SIM card operator	<ul style="list-style-type: none"> Use a multi-carrier SIM card or a SIM card from another carrier
No network is available for any technology.	<ul style="list-style-type: none"> Place the external antenna connected to the logger in a location where communication is more favorable. For example, if the antenna was placed in a manhole or facility, move it outside.
SIM card is not activated	<ul style="list-style-type: none"> Check with the SIM card provider that it has been activated.



Pay attention to the scope of validity of the SIM card. Some SIM cards may be limited to certain countries or continents depending on the subscription purchased.

By using the advanced mode, it is possible to perform continuous signal strength measurements over a longer period of time. This option can be used to set the best position of the antenna before drilling a hole in the manhole to offset the antenna from the metal cover.

9.7.5. Data sending in FTP(s)

- Insert a SIM card (with a data package of at least 5 MB per month) into the holder. See paragraph [Inserting the SIM card](#).
- When purchasing a SIM card, ask for the operator's APN and PIN code, if available, as this information will be needed.
- Connect the GSM / GPRS antenna to the connector on top of the logger.
- In Avelour, activate **Data sending via Internet: FTP / CoAP**

- Select the data **transmission cycle**.

By default, the logger is programmed to send data to Ijitrack. In this case, no modification to the existing configuration is required.

- If you do not have an Ijitrack account, please contact our customer service department.



You will be asked to provide the product number on the logger label and the installation address.

- If data is being sent to a server other than Ijitrack, click on the  icon in the top right of the screen to go to advanced settings and display the following parameters:

- If necessary, contact the FTP server administrator to obtain the three parameters required to send data to a server:
 - Server name or IP address: "Server"
 - Name of user accessing the server: "Username"

- Password associated with the user: "Password"
- Click on the  **FTP data transmission test** button to check that data transmission is working correctly.



-> If data is transmitted, the following window appears:

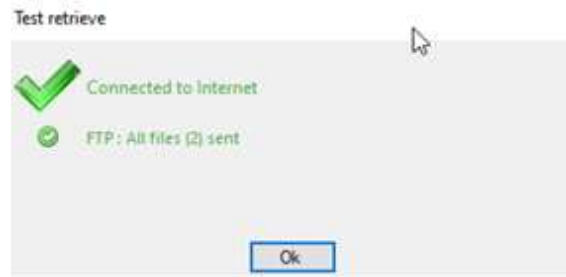

- After a few minutes, check that the data has arrived on the Ijitrack account or on a different Ijitrack server.

9.7.6. Data sending in Http(s)



Requires firmware version later than or equal to 22.04.

Configuration

Under “Internet data sending”,

- Activate **Internet data sending** and select the HTTP protocol,

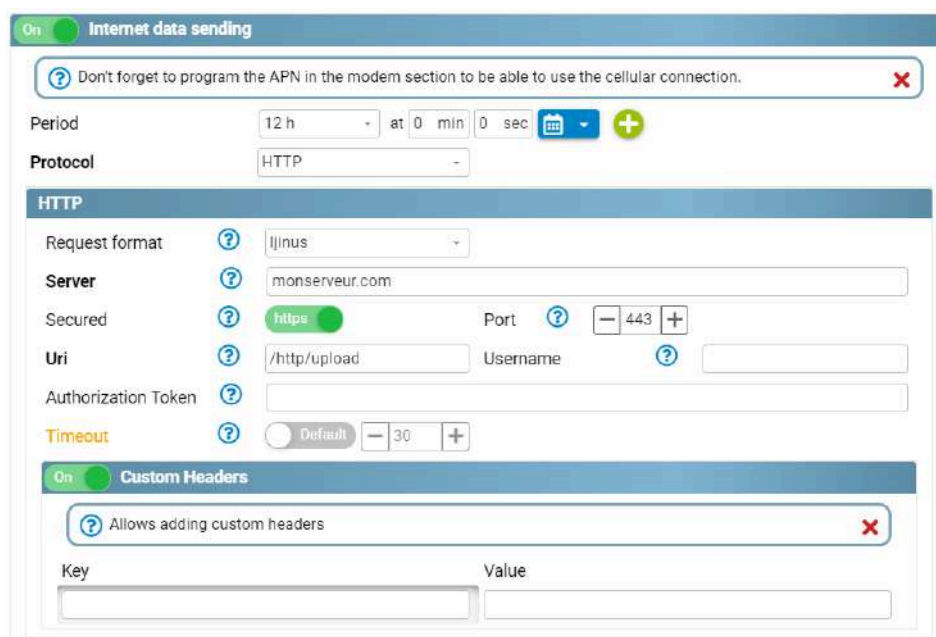

Sending data via HTTPS in ijinus format

- **Request format:** Ijinus, Topkapi, Azure IoT Hub.
 - **Ijinus:** Ijinus is a format that allows interoperability with most systems. It is fairly generic and contains all the information you might need. Moreover, custom values can also be added in the header.
 - **Topkapi:** Specific format for compatibility with Topkapi.
 - **Azure IoT Hub:** Format for compatibility with the Azure platform.
- **Server:** Enter the URL of the target server (without http/https). For ijinus, the server is files.ijitrack.com.
- **Port:** Enter the HTTP listening port on the server side.
- **Secure:** HTTP or HTTPS.
- **Uri :** Enter the url of the http request. Not available for ijinus format with files.ijitrack.com server.
- **User name:** With Ijinus format. If needed. It will be included in the body of the request in the user form. It is useful when sending to Ijinus servers.
- **Authentication token:** Enter the authorization token, if required. Will be included in the request body in the Authorization header.

- **Timeout:** Enter an http request timeout in seconds.
- * **Custom headers*:** With the Ijinus format. Enables custom headers.
 - **Key:** Enter the header key to be added.
 - **Value:** Enter its value.

Ijinus format

Format of the request sent via a **POST** for the Ijinus format.

POST_Request		
Header	Authorization	58d97_32fb3
	<Key0>	<Value0>
	<Key1>	<Value1>
	<Key2>	<Value2>
	<Key3>	<Value3>
form-data body	tz	Europe/Paris
	user	ijinusHTTP
	sn	IJA0102-12345678
	crc32	1234ABCDE
	file	data.bin

URL

The url will be in the form: [http|https]://

In the example above the url will be: https://myserver.com/http/upload.

Request header

- **Authorization:** Authentication token, if required.
- **Key0:** Custom header 0.
- **Key1:** Custom header 1.
- **Key2:** Custom header 2.
- **Key3:** Custom header 3.

Body

The body is in form-data format.

- **tz:** Enter the timezone configured in the sensor.
- **user:** Enter the user (as defined [above](#)).
- **sn:** Enter the sensor serial number.
- **filepath:** Enter the file path and its name into the sensor.
- **crc32:** Enter the CRC32 of the file.

-
- **file:** Enter the file in `application/octet-stream..`

Topkapi format

For TOPKAPI communication:

- Enter the server name or IP address and the Authentication Token provided by TOPKAPI.
- For sensor configuration in TOPKAPI, refer to TOPKAPI documentation.

Azure IoT HUB format

For preformatted transmission to Azure IoT Hub.

The uri is preconfigured in the right format: `/devices/ $id/messages/events?api-version=2021-04-12`

Request header:

Header	
Authorization	58d97-32fb3

The body is in the format "

```
{  
  "payload": "base64:sdip<gs5fsd465ggsgs"  
}
```

9.7.7. Data sending in MQTT(s)

Principle

MQTT is a client-server messaging protocol using the publish/subscribe architecture.

At the heart of MQTT are MQTT brokers and clients. The Broker is an intermediary between senders and recipients. Its role is to distribute messages to the appropriate recipients. Clients post messages to the broker and other clients subscribe to specific topics to receive messages.

Each message includes a topic and customers subscribe to topics that interest them. The broker maintains a list of subscriptions and uses it to deliver messages to the relevant clients.

A broker can also buffer messages for disconnected clients, ensuring reliable message delivery even under unreliable network conditions. To enable this, MQTT supports three different Quality of Service (QoS) levels for message delivery: 0 (at most once), 1 (at least once), and 2 (exactly once) (HiveMQ).

Message format

The format of MQTT messages is json (JavaScript Object Notation).

```

Topic: Ijinus/Logger/IJA0102-00001848/DATA/diag QoS: 0 Retained
{
  "sn": "IJA0102-00001848",
  "tzMinutesOffset": "+120",
  "tzLabel": "CEST",
  "descriptors": [
    {
      "datatype": 6,
      "channel": 0
    },
    {
      "datatype": 6,
      "channel": 1
    },
    {
      "datatype": 3,
      "channel": 7
    },
    {
      "datatype": 17,
      "channel": 0
    }
  ],
  "records": {
    "2025-04-10T11:45:08Z": {"0": 3.45, "1": 3.35, "2": "221", "3": -73}
  }
}

```

Activation



The logger must be equipped with a modem board with a SIM card.

- In Avelour, activate **Internet data sending**

- Set a transmission cycle.
- Select the **MQTT** protocol.

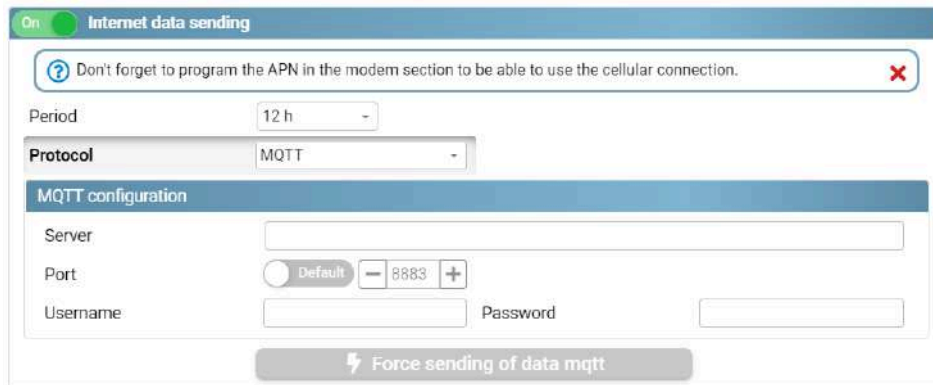

Configuration

- Enter the **Server** identifiers, **Port**, **Username** and **Password**.

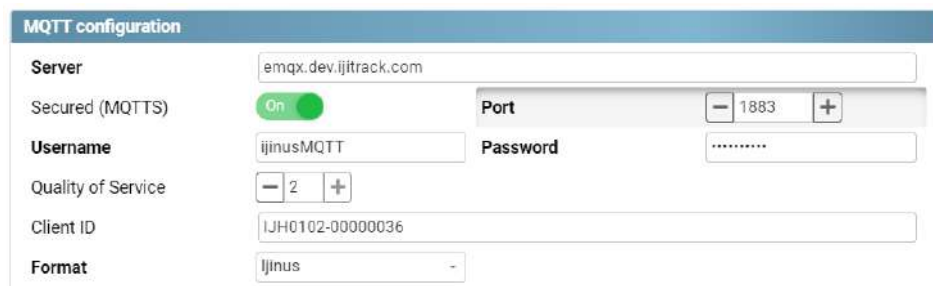

Quality of Service (advanced setting)

The MQTT protocol has a quality of service (or QoS) mechanism, which guarantees the delivery of messages to the client in the event of a failure (e.g., connectivity).

- Click on  to display the advanced setting **Quality of service** and enter a value of 0, 1, or 2.

QoS 0: Lowest quality. The message is only sent once. In the event of a failure, some messages may not be delivered. This quality may be suitable for sending sensor data where occasional data loss would not significantly impact the overall results.

QoS 1: Quality level where messages are confirmed and resent if necessary. This level of quality of service is typically used in situations where message loss is unacceptable, but message duplication is tolerable. This is suitable for sending command messages to devices, where a missed command can lead to serious consequences, but duplicate commands do not.

QoS 2: This level enables "exactly once" delivery, where messages are confirmed and resent until they are received exactly once by the subscriber. Quality of Service level 2 is the highest level of quality of service and is generally used in situations where message loss or duplication is completely unacceptable. With QoS 2, the client and broker use a two-step confirmation process, in which the broker stores the message until it has been received and acknowledged by the subscriber. This level of quality of service is typically used for critical messages such as emergency alerts.

Format Almaviva

In the **Almaviva** format, The option "**Send descriptor**" allows to open a new /DESC channel describing the correspondence between the recorded data tracks and the "Var".

Format Send descriptor

Topic

? For Almaviva format, topic structure will be:

- Ijinus/Logger/IJH0102-00000036/HData
- Ijinus/Logger/IJH0102-00000036/LOG
- Ijinus/Logger/IJH0102-00000036/DESC

Topic Prefix

Topic (advanced setting)

The MQTT messaging model is based on topics and subscriptions. Topics are channels where messages are posted and subscribed to. Topics are hierarchical and can contain multiple levels separated by slashes, like a file path.

- Click on  to display the advanced setting **Topic** and customize the topic format if needed.

Topic

? Topic format will be:

- Ijinus/Logger/IJA0102-00000129/DATA/#
- Ijinus/Logger/IJA0102-00000129/LOG/#

ClientID GroupID

9.7.8. Advanced internet connection settings

In advanced mode , the following parameters are displayed:

PPP	
Attempts to connect	<input type="radio"/> Default <input type="text" value="3"/> <input type="button" value="-"/> <input type="button" value="+"/>
Timeout to connect	<input type="radio"/> Default <input type="text" value="15"/> <input type="button" value="-"/> <input type="button" value="+"/>
SNTP	
Sntp server	<input type="radio"/> Default <input type="text" value="time.cloudflare"/>
DNS	
Alternative DNS server	<input type="text" value="1.1.1.1"/>
Prioritise the alternative DNS server	<input type="radio"/> Off

PPP

PPP : Point to point Protocol -> Internet transmission protocol that enables a connection to be established between two hosts over a point-to-point link.

SNTP

SNTP : Simple network time protocol -> Protocol used to synchronise the clocks of devices on a data network.

- Activate  **Sntp server** and enter the server address for synchronisation.

Custom DNS server

Alternative DNS server : If necessary, enter the IP address of the custom DNS server to add it to the list contained on the SIM card.

Prioritise the alternative DNS server : Must be enabled to allow priority use of custom DNS.

9.7.9. Certificate management

Generalities

A digital certificate or public key certificate is used primarily to identify and authenticate a natural or legal person, but also to encrypt communications. It can be compared to a digital identity card.

A digital certificate is a data file that associates a publicly known cryptographic key with an organization.

Electronic certificates are verified using a chain of trust. The anchor point of this chain is the *root certification authority*.

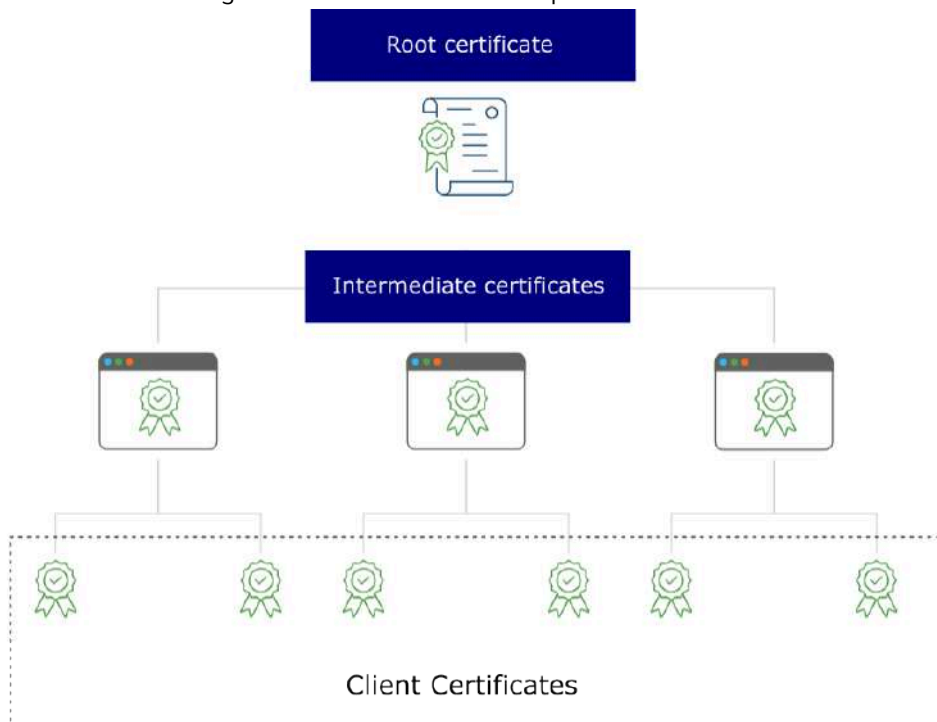

Root certificate

A root certificate, often referred to as a CA certificate, is a digital certificate that serves as the basis for a public key infrastructure (PKI) system. It is issued by a trusted certification authority (CA) and is self-signed, meaning that the CA authenticates itself. Root certificates are stored in a trusted repository known as a root store, which is maintained by browsers and operating systems to authenticate secure connections.

Intermediate certificate

The intermediate certificate serves as a bridge between the root certificate and server certificates, such as TLS certificates for websites. Unlike root certificates, intermediate certificates are not self-signed; they are signed by a root certificate or another intermediate certificate. This structure creates a hierarchy known as a chain of trust.

Managing certificate



The Certificate Management feature button is only visible if the protocol is enabled as secure.

Secured (MQTTS)



 Certificate Management

General

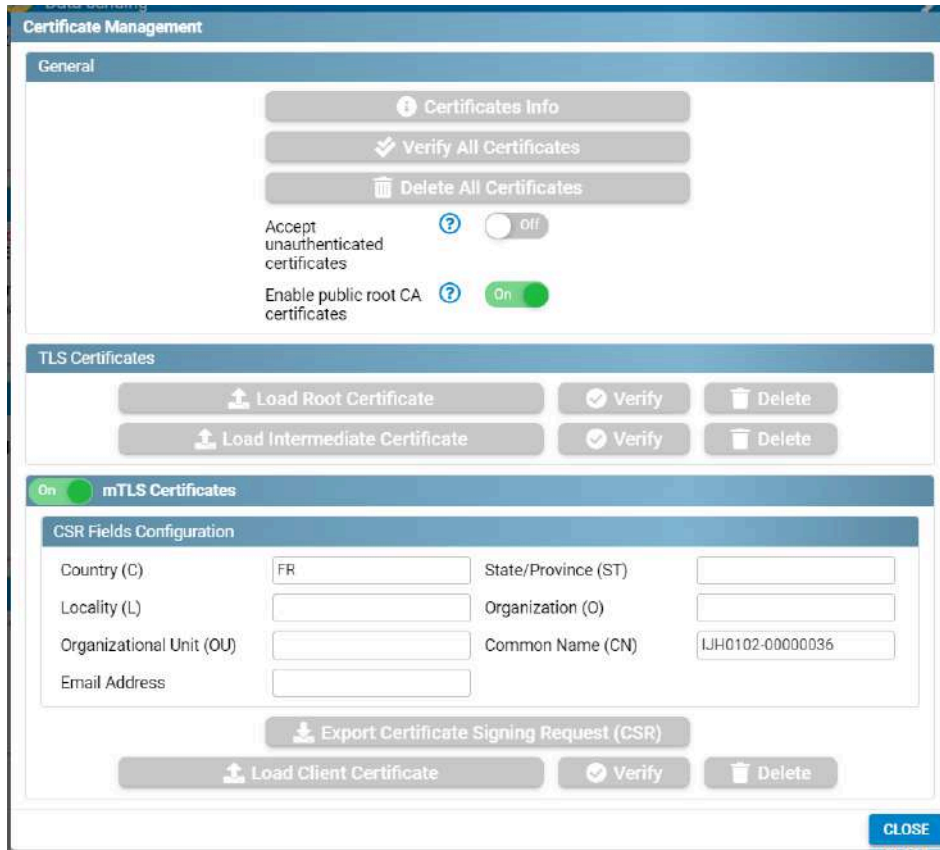

The **Accept unauthenticated certificates** feature, i.e., certificates that are not signed by a trusted certification authority, can be useful in development and testing environments.

The **Enable Public Root CA Certificates** feature allows you to authorize only private or public certificates.

mTLS certificates

Mutual TLS (mTLS) is an authentication method that ensures secure communication between both parties in a connection. Unlike the traditional TLS method, which only verifies the identity of the server, mTLS authenticates both the client and the server by exchanging and validating digital certificates.

mTLS ensures that the parties at each end of a network connection are who they claim to be by verifying that they both possess the correct private key. The information contained in their respective TLS certificates provides additional verification.

1. The client connects to the server
2. The server presents its TLS certificate
3. The client verifies the server certificate
4. The client presents its TLS certificate
5. The server verifies the client's certificate
6. The server grants access
7. The client and server exchange information via an encrypted TLS connection

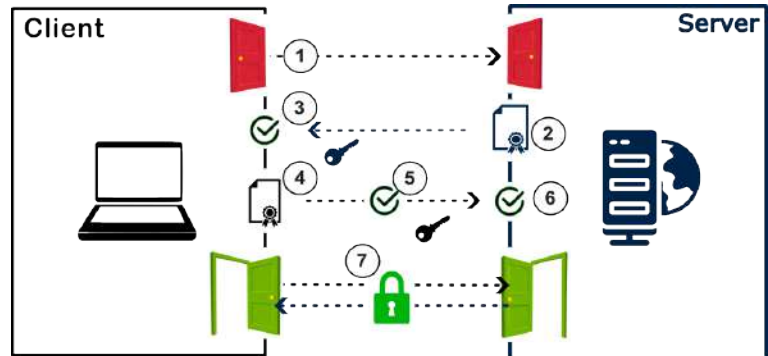

CSR certificate and client certificate

To obtain a client certificate, a certificate signing request (CSR) must be made to a CA in order to obtain a client digital identity certificate.

- Fill in the CSR fields and export the request.
- Upload the client certificate (.pem or .ce)

9.7.10. Data sending via SMS

To configure SMS data transmission:

- Click on "EDIT" in the "Data sending" block.

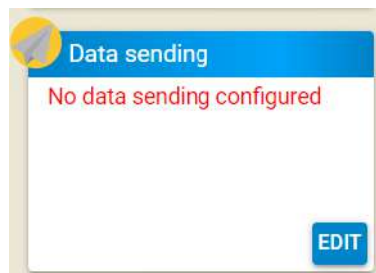

- Activate "SMS data sending".

The **Sending period** corresponds to the frequency at which data are transmitted.

In the example below, transmission occurs every 12 hours:



To check that SMS messages have been sent correctly:

- Enter a phone number in the **Send a test SMS** field indicating the country code (+33 for France).
- Then click on the **Send a test SMS** button and check that the SMS has arrived on the phone identified.

```
IJA0102-00002088  
Ver : 0129/01-1  
Rev : 21.13 (2023/04/03 - Radar)  
2023/11/10 17:04:04  
Rat: 2G GSM-900  
Oper : Orange  
Rssi : -49 dBm (ext)
```

Example of an SMS received on the recipient's phone

- Enter the **server phone** number to transmit the data.

The **SMS Site ID** is a value that identifies the logger on the server and the supervision system used to display the data.

- If data are sent to the Ijitrack web service, no modification is required.
- If data are sent to another supervision system, contact the person in charge of supervision to define the correct SMS Site ID.

9.7.11. Data sending in LoRaWAN



The configuration of data transmission in LoRaWAN is available from version 7.1.2 of the Avelour software.

A logger equipped with an built-in modem has a unique identifier (DevUID). This identifier is required to configure your LoRaWAN server (LNS: Lora Network Server).

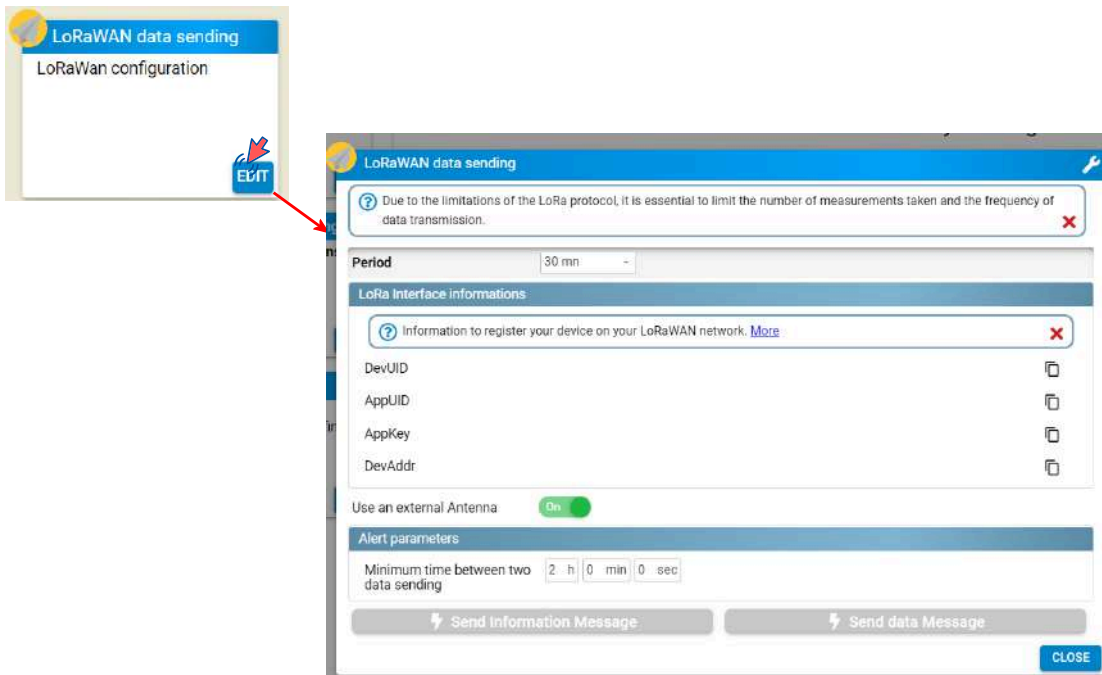

Transmission cycle

- Select the frequency of the data transmission cycle on the LoRaWAN server.

Login information

DevEUI: Identity of the end device (64 bits).

AppEUI: Identity of the application (makes the owner of the end device unique).

AppKey: Key used by the server and the end device to encrypt and decrypt packet data.

DevAddr: Identity of the end device (32 bits).

Test data transmission

- Click “Send information message” to send a message containing diagnostic information
- Click “Send data message” to send a message containing measurement data.

Advanced settings

Downlink Waiting Time 	<input type="text" value="1000"/> ms <input type="button" value="+"/>	Timeout 	<input type="text" value="10000"/> ms <input type="button" value="+"/>
Request for acknowledgment 	<input type="checkbox"/> Off	Multiple send 	<input type="text" value="1"/> <input type="button" value="+"/>

Downlink waiting time

Waiting time between the end of message transmission and the start of the LNS downlink frame listening phase (for TTN: 5000 ms)

Timeout

Maximum network connection time (ms).

Request for acknowledgement

For all transmissions, activate the request for acknowledgement from the LNS.



Depending on the platform, this may be a paid option.

Multiple send

If there is no acknowledgement, data can be sent multiple times to increase the reception rate.

Expert mode

Reset period

Modem reset periods to ensure that the modem is working. Forces the modem to disconnect from and reconnect to the network.

Use an external antenna

On: External antenna

Off: Internal antenna

Integration of a logger on Orange Live objects

- Select the "Generic_classA_RX2SF12" profile.
- Copy and paste the identifier (DevEUI) and the keys (AppKey and AppEUI) from the data provided in Avelour.

Interface - LoRa

DevEUI *

Profil *

Options de connectivité Macro-géolocalisation LoRa

Plan de connectivité *

AppEUI *

AppKey *

Integration of a logger on WIOTYS

- Select the “LorawanPrivate” protocol
- Copy and paste the identifier (DevEUI) and the keys (AppKey and AppEUI) from the data provided in Avelour.

PARAMÈTRES

DevEUI *

App Key *

AppEUI *

Type d'activation

Classe

Integration of a logger on THE THINGS

- Select “Enter end device specifics manually”
- Fill in the Frequency plan, LoRaWAN version and Regional Parameters fields as shown below:

Register end device

Does your end device have a LoRaWAN® Device Identification QR Code? Scan it to speed up onboarding.

[Scan end device QR code](#) [Device registration help](#)

End device type

Input method

- Select the end device in the LoRaWAN Device Repository
- Enter end device specifics manually

Frequency plan

Europe 863-870 MHz (SF12 for RX2)

LoRaWAN version

LoRaWAN Specification 1.0.2

Regional Parameters version

RP001 Regional Parameters 1.0.2

Show advanced activation, LoRaWAN class and cluster settings

Provisioning information

JoinEUI

..... Confirm

To continue, please enter the JoinEUI of the end device so we can determine onboarding options

- Copy and paste the identifier (DevEUI) and the keys (AppKey (= JoinEUI) and AppEUI) from the data provided in Avelour.

Provisioning information

JoinEUI = AppEUI (Avelour)

70 B3 D5 32 60 00 01 00 Reset

This end device can be registered on the network

DevEUI

70 B3 D5 32 60 07 29 D8 Generate 0/50 used

AppKey

AA 4E 6C 37 85 E3 3A 5E F8 45 31 30 8D CE E8 AC Generate

End device ID

eui-70b3d532600729d8

This value is automatically prefilled using the DevEUI

9.7.12. Configure an alarm

To avoid draining the internal battery too quickly in the event of a programming error, a safety feature can be configured: "alarm parameter ". By default, this parameter imposes a minimum duration of 2 hours between two transmissions related to an alert.

- In the "data sending" window,



- Enter a minimum time between two transmissions.

9.7.13. Sending an alert SMS



The server phone number needs to be configured.

The SIM card must allow sending of SMS text messages.

Sending an alert SMS only works if a threshold is exceeded and Anticipate data sending is active.

- Enter a phone number in the "Send alert SMS" window.

-> A second input field appears, allowing you to add another operator and each time a field is filled another field appears.



It is possible to add up to a maximum of 9 phone numbers.





If data is sent using FTP, approximately 3 minutes elapses between the time that the threshold is exceeded and the message is received.

9.8. Test data transmission before commissioning

9.8.1. Objective

Before commissioning an Ijinus datalogger equipped with a communication PCB, you must ensure it operates correctly in the field with the selected communication networks.

9.8.2. Test procedure

1. In the data transmission menu, click on the edit button, when the popup opens click on the wrench  in the top right to display the advanced settings.
2. Configure the modem part as shown below:



The screenshot shows a configuration form with the following fields and values:

- Technology to use:** LTE-M
- Region:** World
- Priority operator:** Active, with a code field containing 10000.
- PIN code:** Active, with an empty code field.
- APN:** lot.1nce.net
- PPP phone:** Inactive, with an empty field.
- PPP user:** Inactive, with an empty field.

- Select “LTEM” technology only.
- Set the location to **world**.
- Enter the **APN** linked to your SIM card.
- Activate the priority operator: the space to enter the code is now available (you will need to know the operator code beforehand — see the list of operators in the country).

3. Program the modem. 

4. Run modem diagnostics .

5. Activate  data sending by Internet with the desired transmission cycle.

6. Start a data transmission test.

9.8.3. Troubleshooting

Network connection issues can occur at key stages of the test:

Problem	Step	Corrective action
Failed to connect to the network	4	<ul style="list-style-type: none"> • Change the priority operator and redo from step 3 on existing networks

		<ul style="list-style-type: none"> • Increase timeout from 120 s to 180 s (see image below) 
Failed to connect to SNTP server	6	<ul style="list-style-type: none"> • Check the APN code • Change the priority operator and try again
Connected to the SNTP server but failed to connect to the FTP	6	<ul style="list-style-type: none"> • Check the FTP server identifiers

9.9. Sending logger configuration using server (remote configuration)

9.9.1. Principle

To modify the settings of a logger without being connected via radio link (wiji), you need to have specific access to the Ijitrack server.

Remote configuration cannot be performed via SMS. Only the **Internet data sending** option allows you to send data and receive a new configuration file.

In fact, data is no longer sent to the root of the Ijitrack server but to a specific space protected by a username and password that are different from those used for Ijitrack.

These server access settings must be entered into the Avelour software when configuring the radio link recorder.

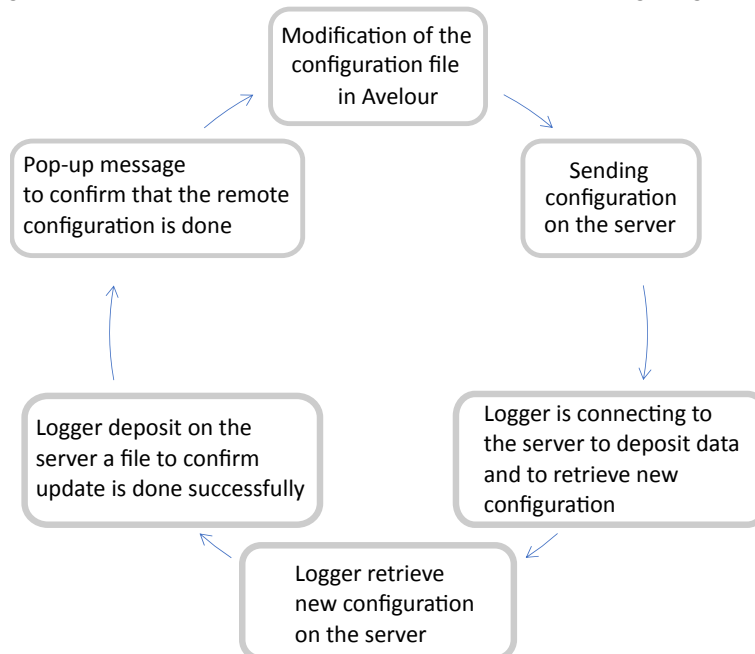

9.9.2. Configuring server access on Avelour

FTP



Contact customer service to unlock the feature that allows you to customize specific access other than Ijitrack.

- In the **Options** menu, click on **Configuration** and go to the **Remote Config** tab.
- Enter the broker name, the username and the password.
- When it's done, click on "Test MQTT" button to check that the connection between Avelour and the MQTT Broker is available.
- If yes, it's possible to modify a setting or a Firmware remotely.
- If not, a modification must be done on written data.

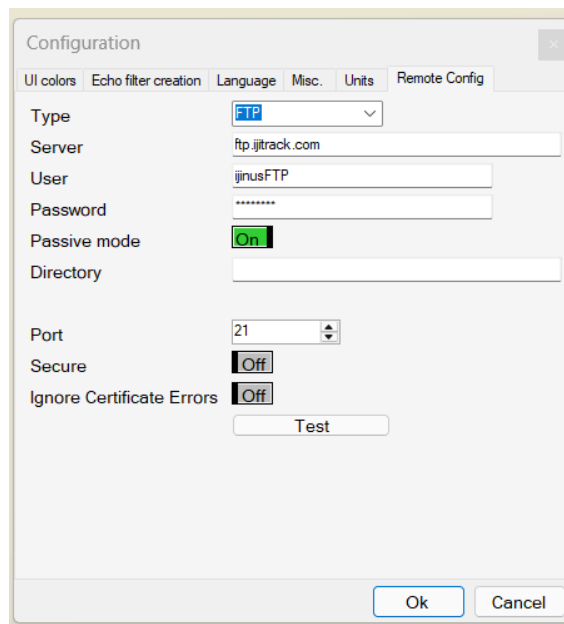

The screenshot shows a 'Configuration' dialog box with the 'Remote Config' tab selected. The fields are as follows:

- Type: FTP (dropdown menu)
- Server: ftp.ijitrack.com (text input)
- User: ijinusFTP (text input)
- Password: masked with asterisks (text input)
- Passive mode: On (checkbox)
- Directory: (empty text input)
- Port: 21 (spin box)
- Secure: Off (checkbox)
- Ignore Certificate Errors: Off (checkbox)
- Test: (button)

At the bottom right, there are 'Ok' and 'Cancel' buttons.

HTTP



Contact customer service to unlock the feature that allows you to customize specific access other than Ijitrack.

- In the **Options** menu, click on **Configuration** and go to the **Remote Config** tab.
- Enter the access parameters (Server, user, API key, port) exactly as they were entered in the data transmission configuration.
- When it's done, click on "Test HTTP" button to check that the connection between Avelour and the MQTT Broker is available.
- If mTLS is enabled, refer to the paragraph [Certificate management](#).

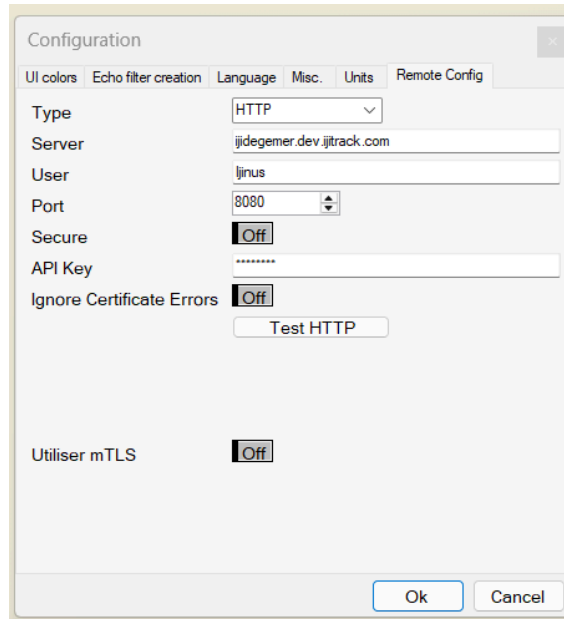

Configuration

UI colors Echo filter creation Language Misc. Units Remote Config

Type

Server

User

Port

Secure Off

API Key

Ignore Certificate Errors Off

Utiliser mTLS Off

MQTT



Contact customer service to unlock the feature that allows you to customize specific access other than Ijitrack.

- In the **Options** menu, click on **Configuration** and go to the **Remote Config** tab.
- Enter the access parameters (Server, user, API key, port) exactly as they were entered in the data transmission configuration.
- When it's done, click on "Test MQTT" button to check that the connection between Avelour and the MQTT Broker is available.
- If mTLS is enabled, refer to the paragraph [Certificate management](#).

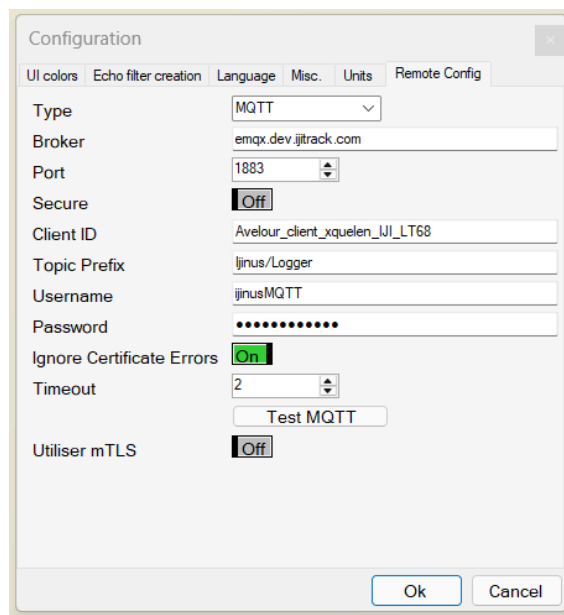

Configuration

UI colors Echo filter creation Language Misc. Units Remote Config

Type

Broker

Port

Secure Off

Client ID

Topic Prefix

Username

Password

Ignore Certificate Errors On

Timeout

Utiliser mTLS Off

9.9.3. Configuring data sending

The use of an FTP server is required to perform remote configuration or firmware updates with internet data sending via FTP, Coap, HTTPS or MQTT.



It is necessary to configure remote FTP in the Avelour options.

If you are using another server, contact Ijinus to obtain a version of Avelour that allows you to customize the server configuration.

- Activate **Internet data sending** and choose [FTP](#), [HTTP](#) ou [MQTT](#) protocol.

FTP

- Enter the access name in the **FTP Server** line by switching the **Default** button to **define**, and enter the access name (TEST in the example below).
- The password is managed automatically by Avelour, but you can enter it in the FTP Password line by switching the **“default”** button to **“define”** and then entering the password.
- The other settings for sending data must not be changed.

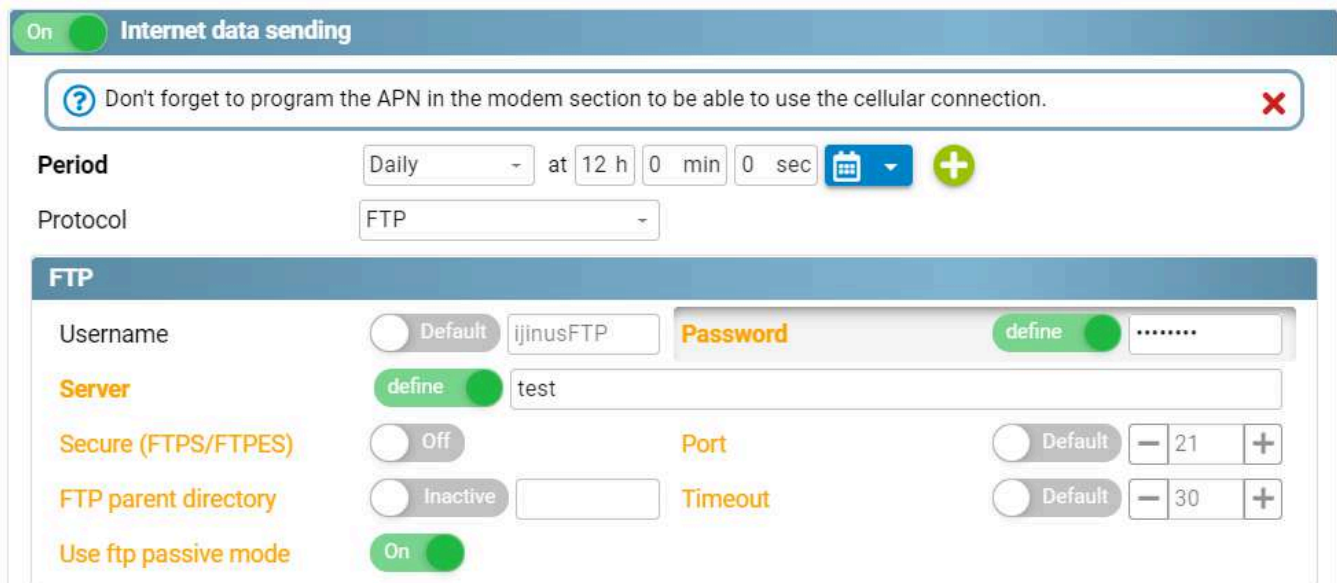

FTP configuration server with FTP protocole

HTTP

- Enter the same settings as those entered in the server access configuration. (???)



Authorization token correspond to API KEY

MQTT

- Enter the same settings as those entered in the server access configuration. (???)

When choosing the **Almaviva** format, it is possible to enable **Send descriptor**, allowing the addition of a topic (/DESC), describing the correspondence between the recorded data channels and the "Var".

9.9.4. Retrieving a configuration via internet

To modify a settings remotely :

- Go in "Actions" menu and click on "Configure a device remotely"

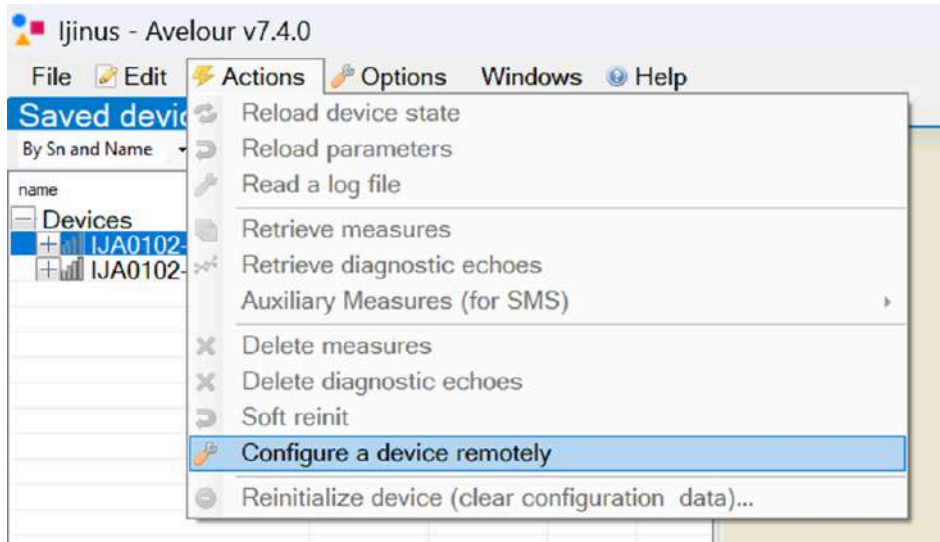

- Enter the serial number of the logger you want to modify remotely :

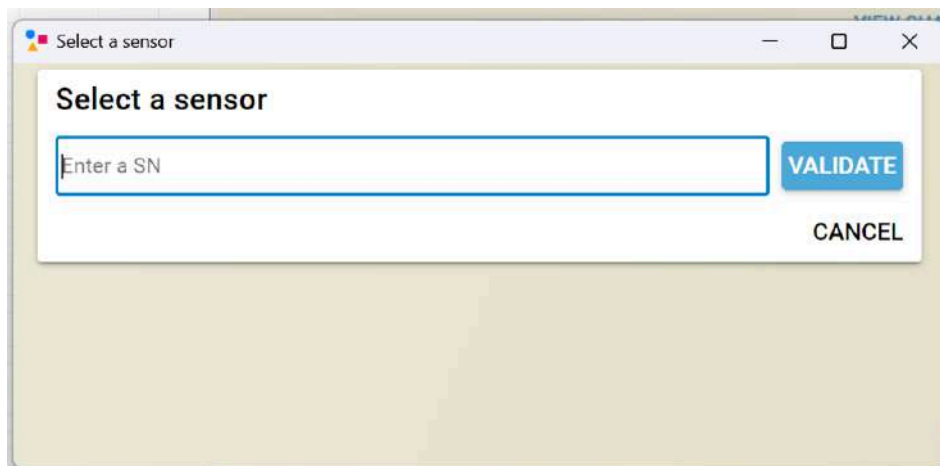

- In this page you can download data (1 week history), echo files, log, or the latest configuration on the broker.
- Click on download latest configuration to be able to modify the configuration.



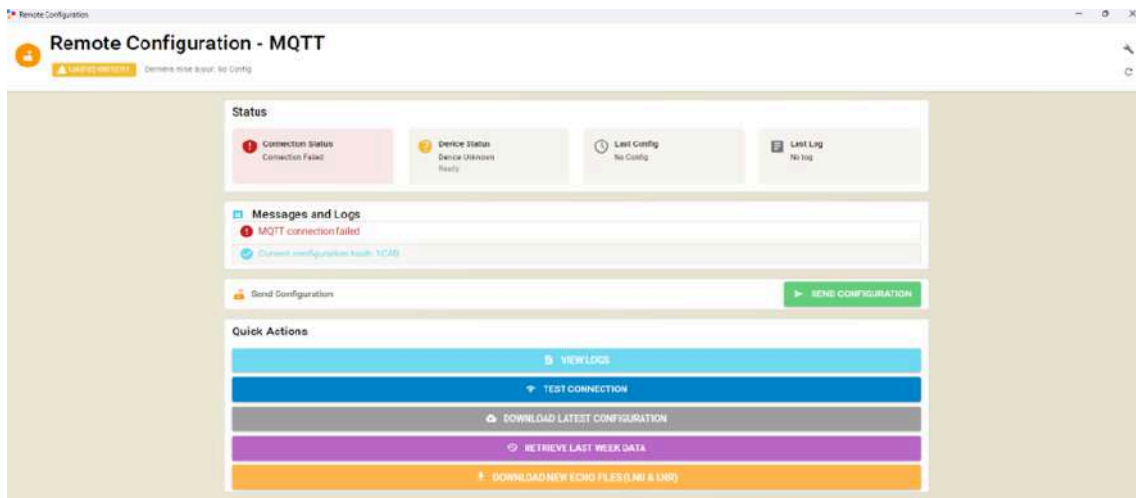

9.9.5. Edit and send the configuration remotely

In the saved data window:

- Open the configuration file for the relevant recorder :
 - Right-click on the configuration file and click on “Show.”
- or
- Double-click on the file.

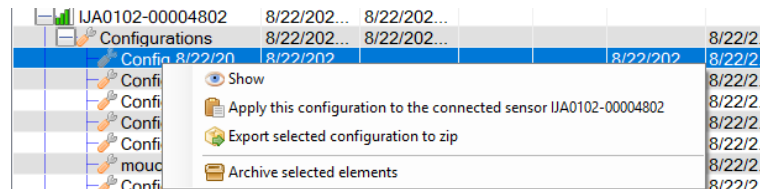

- Click on edit to exit the read only mode and modify the configuration.



- Once modified, click on one of the option : **SAVE CONFIGURATION OR SEND TO FTP** or **SAVE CONFIGURATION OR SEND TO MQTT SERVER** OR **SAVE CONFIGURATION OR SEND TO HTTP SERVER**.



- Enter a name to identify the new configuration that will appear in the saved data.
- Click on Save and send to remote server to upload the new configuration to the server.

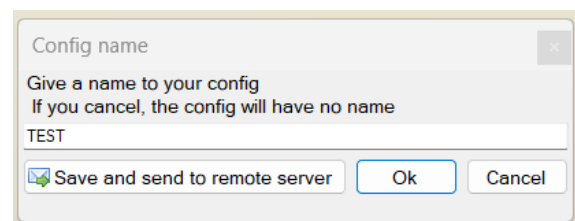

-> The remote configuration window opens, and Avelour connects to the server to verify that the logger has already deposited data on the server.

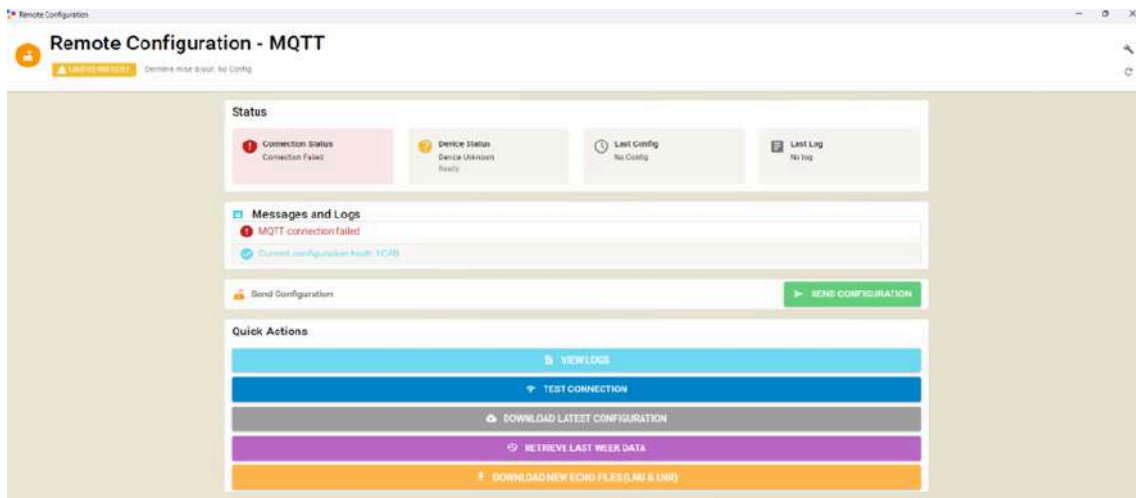

- Check the status and click on “Send configuration”.



Beware ! remote firmware update and remote configuration can't be done simultaneously. Take care to launch one when the other is finished.



- The next time the recorder connects to the server to deposit data, it will download the file containing the modified configuration.
- A check is performed after the update to ensure that the change has been taken into account.

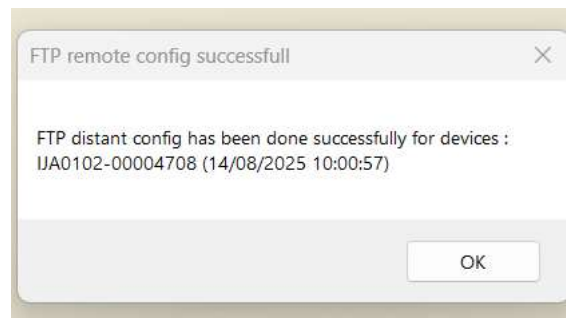

Update pop-up window

9.9.6. Do a remote configuration of a logger without a communication card

If the sensor whose configuration you want to modify does not have a communication card, you must specify the recorder to which it is paired (called the parent device) so that the configuration is first downloaded by the recorder and then sent via the radio link to the target sensor.

If the recorder, whose configuration you want to modify remotely, does not have a communication card, you must configure a recorder with a communication card (Master) to which the recorder will be paired. The configuration will first be downloaded by the master recorder and then sent via the radio link to the slave recorder.

- Edit the **Retrieve Device** feature in the master recorder configuration (with communication card and set up for sending data) by adding the slave recorder (without card). (See paragraph [???](#)).

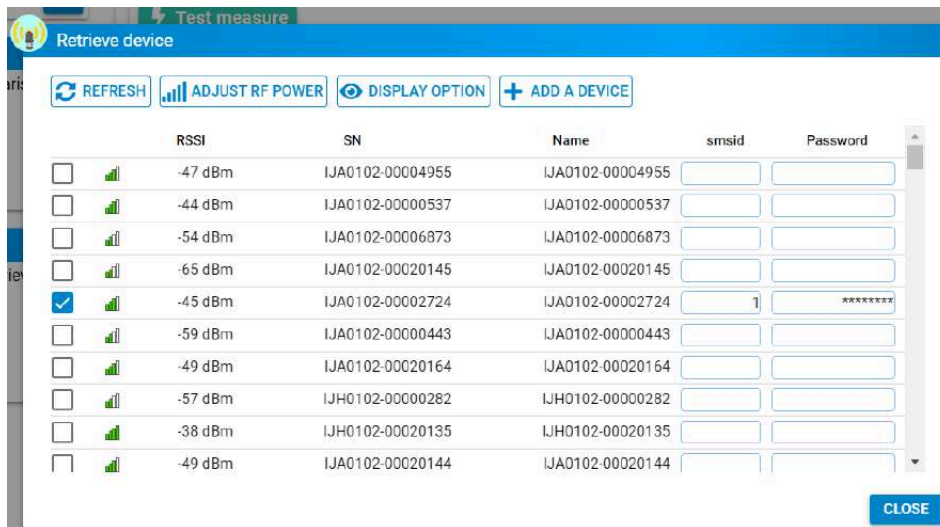

- Save the new configuration.

In the saved data window:

- Open the configuration file for the relevant recorder (without communication card):
 - Right-click on the configuration file and click on "Show."
- or
- Double-click on the file.

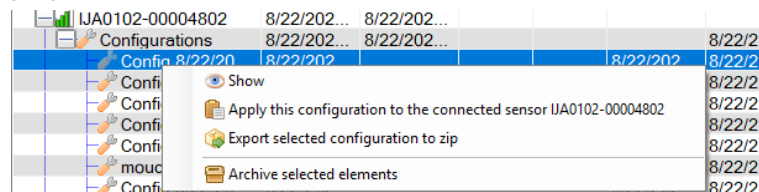

- Click on **EDIT** to exit the read only mode and modify the configuration.



- Once modified, click on one of the option : **SAVE CONFIGURATION OR SEND TO FTP** or **SAVE CONFIGURATION OR SEND TO MQTT SERVER** OR **SAVE CONFIGURATION OR SEND TO HTTP SERVER**.



- The next time the recorder connects to the server to deposit data, it will download the file containing the modified configuration.
- A check is performed after the update to ensure that the change has been taken into account, and a message is displayed on Avelour when data is sent for the first time.

9.10. Power supply configuration

The power supply is managed in the "System Options" window.

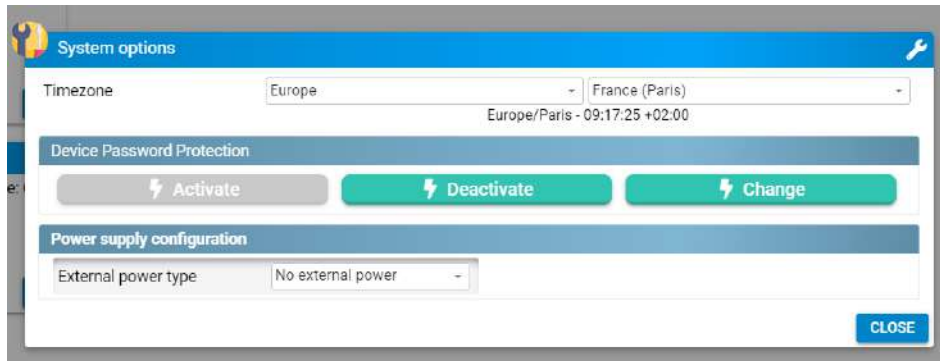

9.10.1. Lithium battery

The logger retrieves the voltage from the external power supply and stops measurements if a minimum voltage threshold is reached. This threshold depends on the type of external power supply and the rated voltage

Examples of thresholds:

- 10.8 V Lithium battery pack: $10.8 \times 0.8 = 8.6$ V.

To configure a 14.4-volt battery pack:

- In expert mode and advanced settings , change the rated voltage from 10.8 to 14.4 V. The threshold for stopping measurements will be $14.4 \times 0.8 = 11.5$ V.

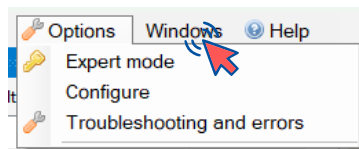

Connector power supply: Select whether the probe is powered directly from the external battery or from the logger's internal power supply, in which case the **voltage applied to the output** can be set between 5 and 18 Volts.

Record external power supply voltage: Enables remote monitoring of pack charge.



You must connect to the logger so that it can take measurements with the external sensor connected.

9.10.2. Lead-acid battery

The logger collects the voltage data from the external power supply and stops measurements if a minimum voltage threshold is reached. This threshold depends on the type of external power supply and the rated voltage.

Examples of thresholds:

- 12 V lead-acid battery: $12 \times 0.875 = 10.5 \text{ V}$.



For a lead-acid battery and if the logger has been configured with a lead-acid battery, you do not need to connect to the logger via Avelour.

To configure a 12-volt battery pack:

- In expert mode and advanced settings  change the nominal voltage to 10.5 V

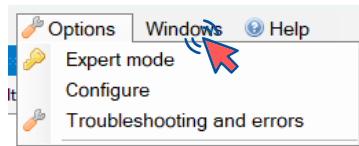

- Reconnect a recharged battery and the logger will resume its operating cycle.

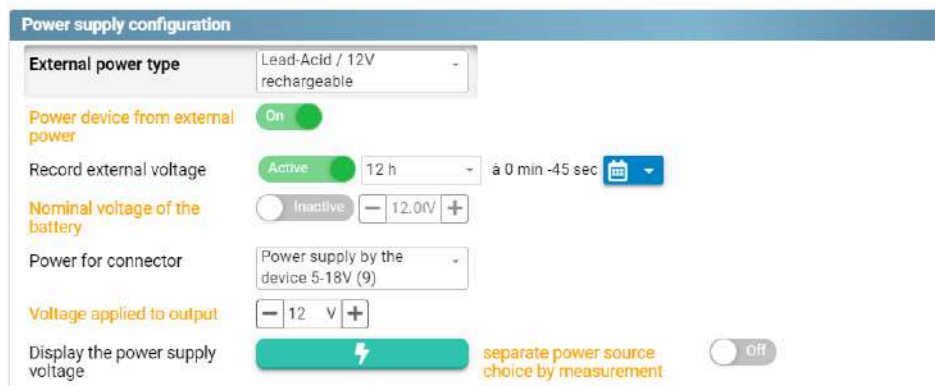

Connector power supply: Select whether the probe is powered directly from the external battery or from the logger's internal power supply, in which case the **voltage applied to the output** can be set between 5 and 18 Volts.

Record external power supply voltage: Enables remote monitoring of pack charge.

9.11. Set time zone

In the "System Options" window:

- Click on the drop-down menu to select the desired time zone (Europe in the example below).
- Select the city corresponding to the desired time zone.

-> The time that will be applied to the logger is then recalculated automatically.

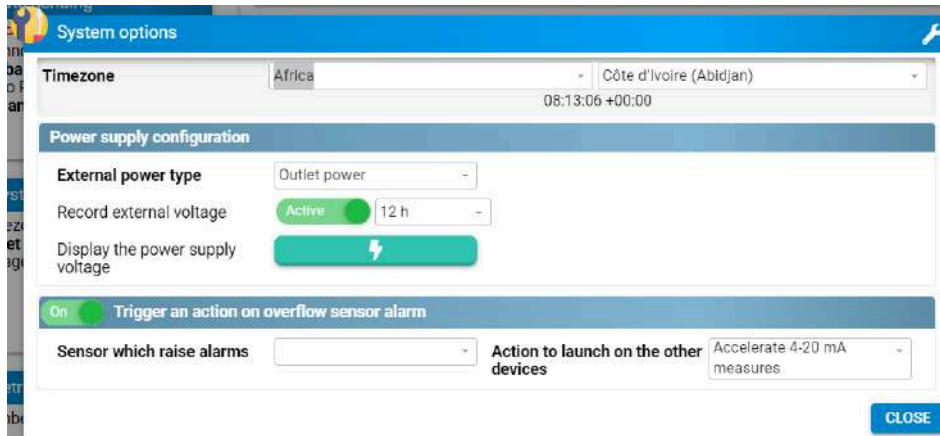

9.12. Pairing one or more loggers

In addition to its measurement capability, a logger can also be used as a hub (or master logger). In fact, it can retrieve data from another logger wirelessly and by radio, if they are less than 25 m apart in an unobstructed open field, or if one is in a manhole, under a metal cover and the other is not (in this case, the distance between the two hubs must be less than 5 m). The "master" logger then retrieves data from a "slave" logger. This option is called pairing and is configured in the "master" logger. No settings are required on the slave logger.

In the "Retrieve devices" block:

- Click "EDIT".

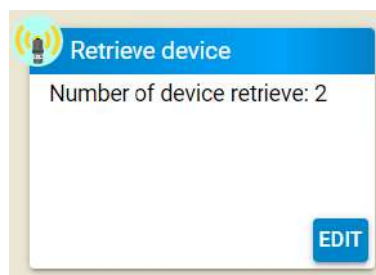

- Select one or more loggers from the list.

-> the software generates an **smsid** to identify data from each paired logger when sent by SMS.



The channel number used by some supervisors to associate equipment data is 0 by default (i.e. cannot be modified via software) for a "master" logger. The channel numbers of paired loggers are set by the "sms id" (here, for example, 1). Each paired sensor will therefore have a different sms id.

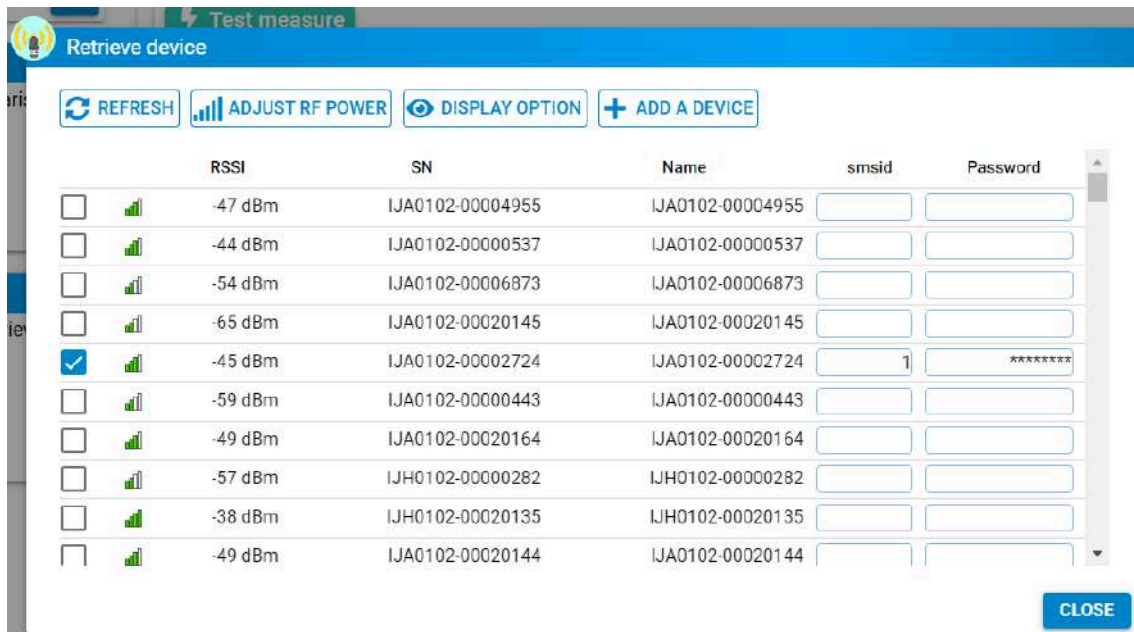

- If the sensor you are looking for is not available, click the "refresh" button to update the page.

9.13. Check the status of data recording and transmission

In the configuration window, two icons allow you to control the status of data recording and transmission.

A : Current status

B : Status after loading the configuration on the logger, useful information to check if the configuration being edited is correctly configured.

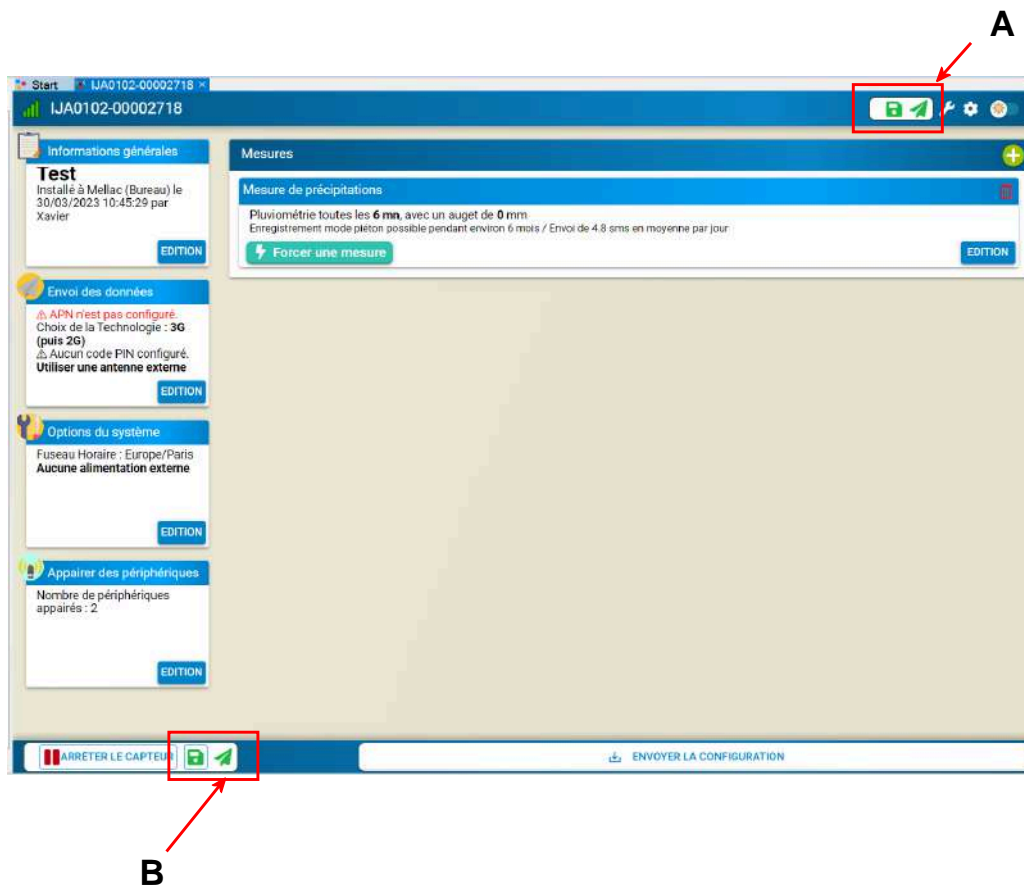

No data are being recorded



No data are being transmitted



Data are being recorded



Data are being transmitted

9.14. Save the configuration to the logger



Prerequisites: The logger is connected to Avelour (see [Connecting to a logger](#)).

To save all the settings configured on the logger:

- Click "SEND CONFIGURATION".

 **SAVE CONFIGURATION**

-> An update loading window is displayed.

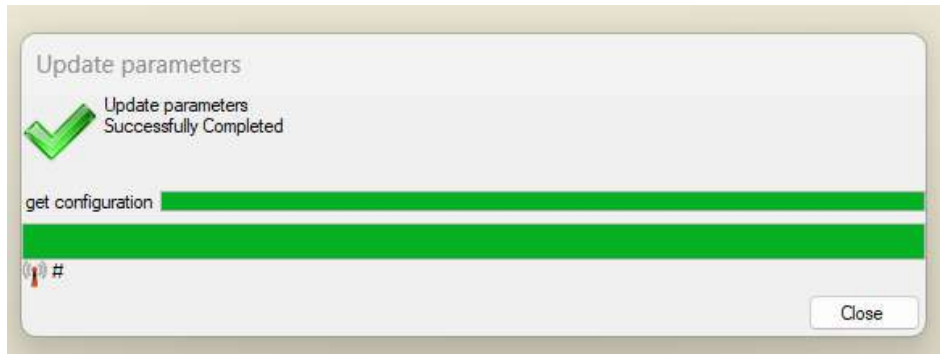

-> Data recording is activated and its status is visible via the  icon located at the top right of the configuration window (see paragraph [Check the status of data recording and transmission](#)).

-> Data transmission is activated and its status is visible via the  icon located at the top right of the configuration window (see paragraph [Check the status of data recording and transmission](#)).

9.15. Visualize measured values in real time



The logger is set up for measurement.

To visualize the values measured and received by radio from the Ijinus loggers located nearby:

- In the windows tab, click on "View measurements received in RF".

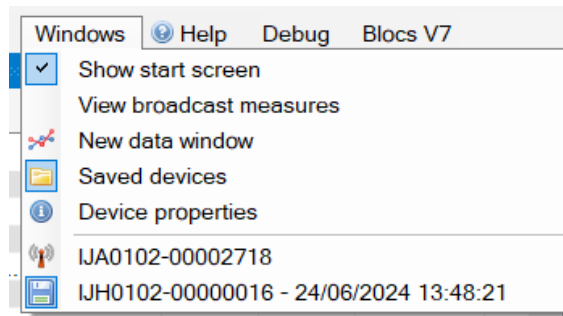

-> A new window is displayed.

SR	Name	LastDate	Current	Planned	Quality	Reliability	Measure	H2S Co.	Capacity	Debug L	Debug R	Rise Int.	Debug L	Value	Oppos.	Oppos.	Oppos.	Oppos.	Count	Value	Scale	Meas.	Oppos.	Dist.	Temp.	Velocity	Pressure	PM10	PM2.5
	Total	09/10/30					21																						
	IJA0102-00002718	01/37/40																											
	IJA0102-00004725	09/13/40			15/15		25																						
	IJA0102-00000020	01/03/30			25/2		27,9					1	3000	114695															
	IJA0102-00003307	09/10/30			5		0																						
	IJA0102-00004011	10/37/30			46		501																						
	IJA0102-00000076	09/12/30																											
	IJA0102-00002302	09/12/30																											
	IJA0102-00001862	09/12/30			15/1		22,6																						
	IJA0102-00003146	09/10/30																											

9.16. Stop a recording in progress

- Click on "Stop sensor" to stop recording measurements.



-> Recording and data transmission are stopped. 

- To restart the measurement, click on restart.



9.17. Disconnect from the logger



Disconnection from the logger occurs automatically after a few minutes when no data is transferred.

To force disconnection from a logger in Avelour:

- Click the cross to close the configuration window.

9.18. Managing a configuration

9.18.1. View a configuration file



it is possible to view a configuration file offline.

In the saved data window:

- Double-click the configuration file to display it in the main window.

IAA102-00004708 (Test)	01/01/2020 ...	15/01/2025 ...
Configurations	21/11/2024 ...	15/01/2025 ...
Config 15/01/2025 1...	15/01/2025 ...	
Config 15/01/2025 0...	15/01/2025 ...	
Config 15/01/2025 0...	15/01/2025 ...	
Test 1	15/01/2025 ...	
Config 14/01/2025 1...	14/01/2025 ...	
Config 14/01/2025 1...	14/01/2025 ...	
Config 14/01/2025 1...	14/01/2025 ...	
Config 14/01/2025 1...	14/01/2025 ...	
Older	21/11/2024 ...	14/01/2025 ...
Data	01/01/2020 ...	27/11/2024 ...
Files	01/01/2020 ...	27/11/2024 ...

9.18.2. Archive a file

Archiving allows you to manage how files are displayed in the saved data window.

In the Saved data window:

- Right-click on the configuration file to archive and click "Archive selected elements".

-> The configuration file is no longer visible and a folder containing the archived files, named "_archive_" is created in the logger directory.

Example: C:\ProgramData\Ijinus\Avelour_Main_7.1.2\SavedSensors\IJA0102-00004708_archive_

- To view the archived configuration file, click "Filter elements" and click "View Archived elements"

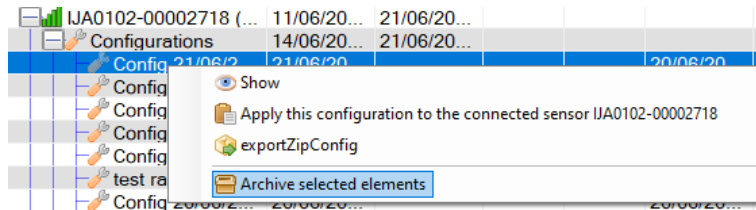

-> The configuration file appears crossed out.

- To retrieve it from the archive, right-click and click "Unarchive selected elements"

9.18.3. Create a configuration template

- Connect to a logger and open an existing configuration via the Saved data window.
- In the "Edit" menu, select "Save device configuration as template".

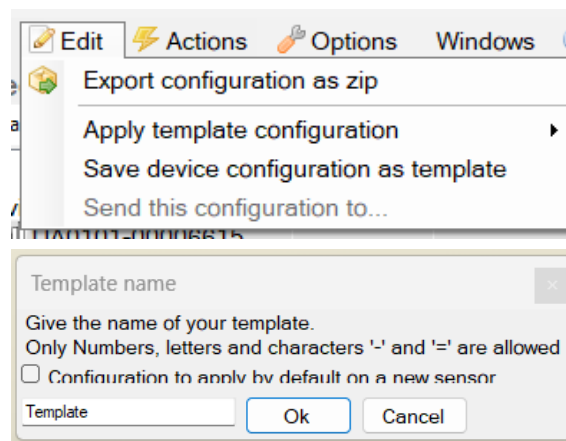

- Check the "Configuration to apply by default on a new sensor" option so that the template is applied automatically when connecting a new logger.
- Enter a name and click "OK".

-> An .IJCZ file is created in the following directory: C:\ProgramData\Ijinus\Avelou_Main_7.xxxxx\userTemplates.

-> The new template is available in the "Edit" menu.

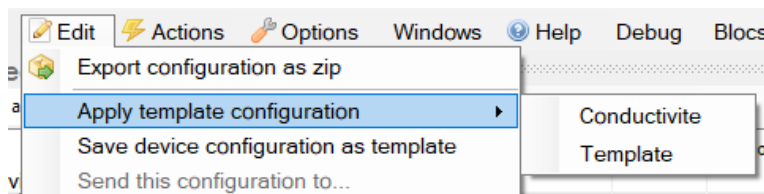

9.18.4. Apply a configuration template



A configuration template must be created. See [Create a configuration template](#).

- Connect to the logger that you wish to apply a template to (see [Connecting to a logger](#)).
- In the "Edit" menu, click on the template to apply.

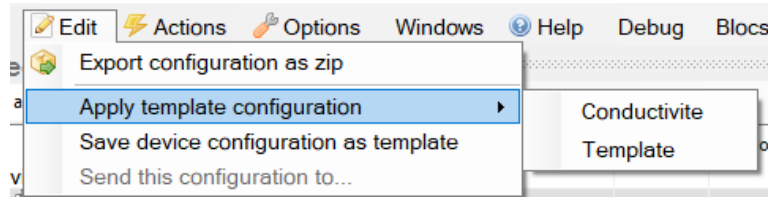

Chapter 10. Data management on Avelour

10.1. Retrieving saved data

To retrieve saved data:

- Connect to the logger (see paragraph [Connecting to a logger](#)).
- Click "Retrieve without deleting" to keep the data in memory in the logger or "Retrieve and delete" to empty the recorder memory.

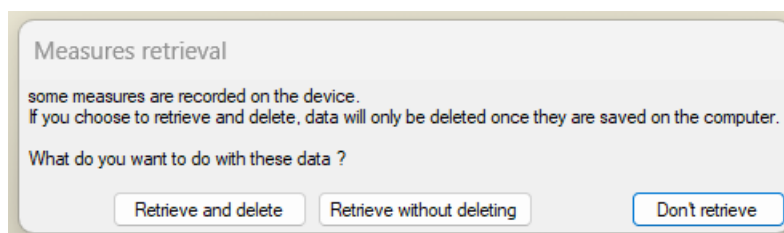

Or

- In the "Actions" menu, click on retrieve measures.

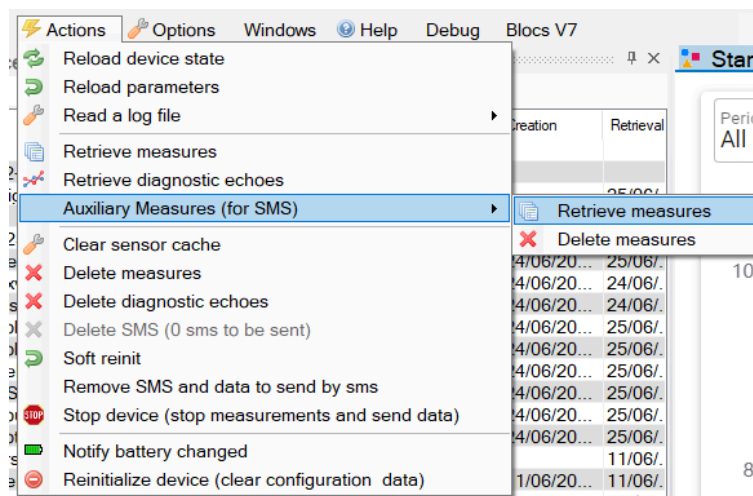

-> The saved data display window opens.

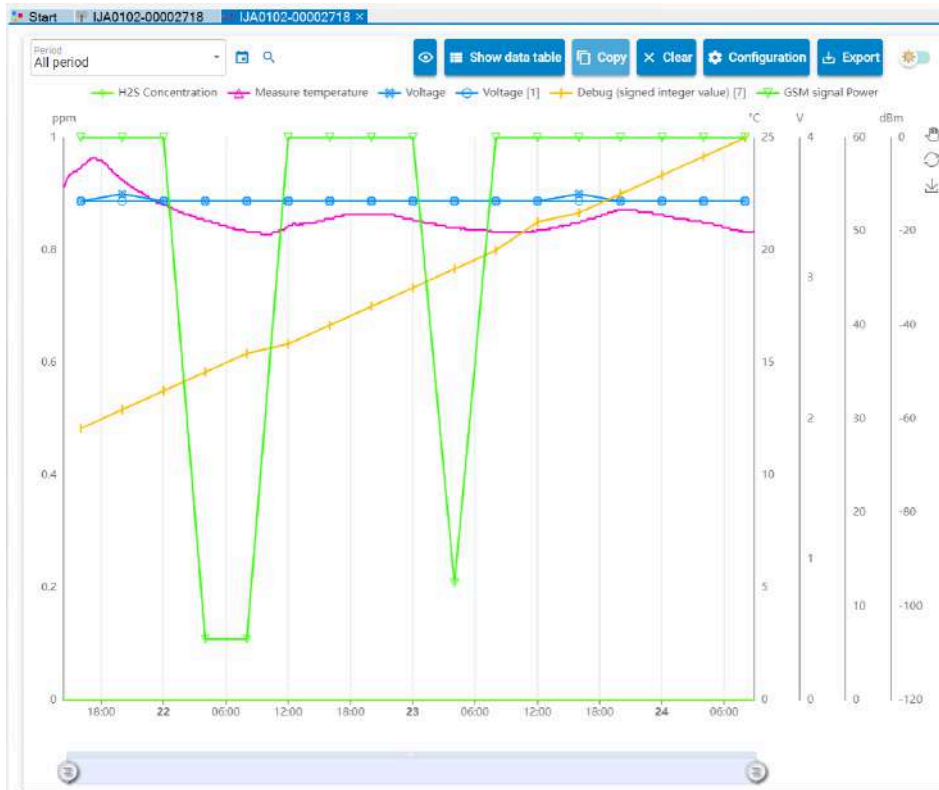

-> In the saved data window, the data appears in the browser structure.

Saved devices

By Sn and Name Device filter

name	First	Last	Data ty...	Records	Creation	Retrieval
Devices						
IJA0102-00002718 (...)	11/06/20...	24/06/20...				
Configurations	24/06/20...	24/06/20...				24/06/...
Data	24/06/20...	24/06/20...				24/06/...
H2S Concentra...	24/06/20...	24/06/20...	0038[...]	40	24/06/20...	24/06/...
Measure temp...	24/06/20...	24/06/20...	0012[...]	40	24/06/20...	24/06/...
Oxygen saturat...	24/06/20...	24/06/20...	0028[...]	39	24/06/20...	24/06/...
Dissolved oxyq...	24/06/20...	24/06/20...	0029[...]	39	24/06/20...	24/06/...
Voltage	24/06/20...	24/06/20...	0006[...]	1	24/06/20...	24/06/...
Voltage [1]	24/06/20...	24/06/20...	0006[...]	1	24/06/20...	24/06/...
Debug (signed...	24/06/20...	24/06/20...	0003[...]	1	24/06/20...	24/06/...
GSM signal Po...	24/06/20...	24/06/20...	0017[...]	1	24/06/20...	24/06/...
Filters	11/06/20...	11/06/20...				11/06/...

10.2. Retrieve diagnostic echoes

In the "Actions" menu,

- Click on **Retrieve diagnostic echoes**.

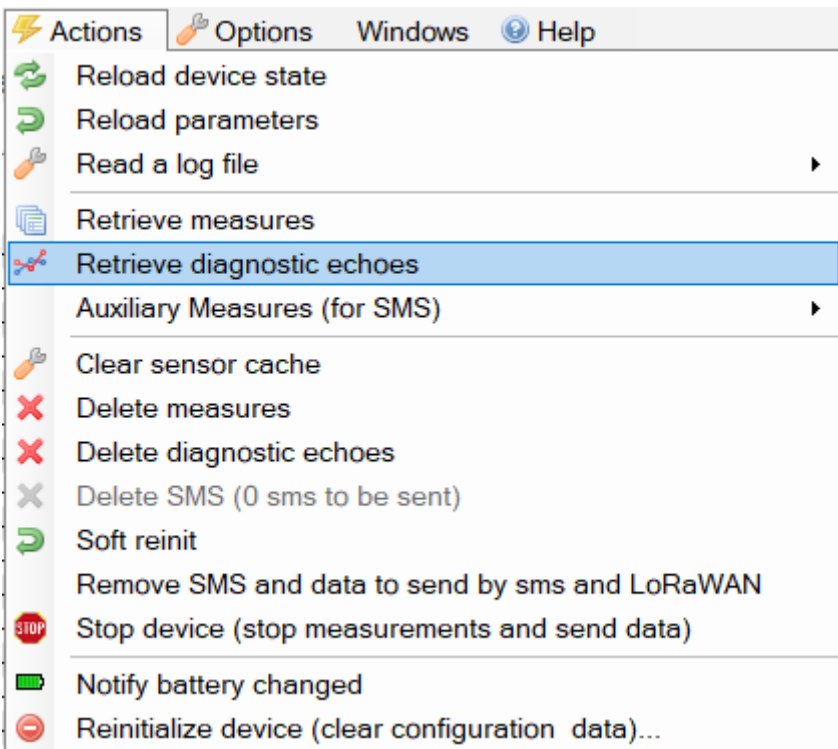



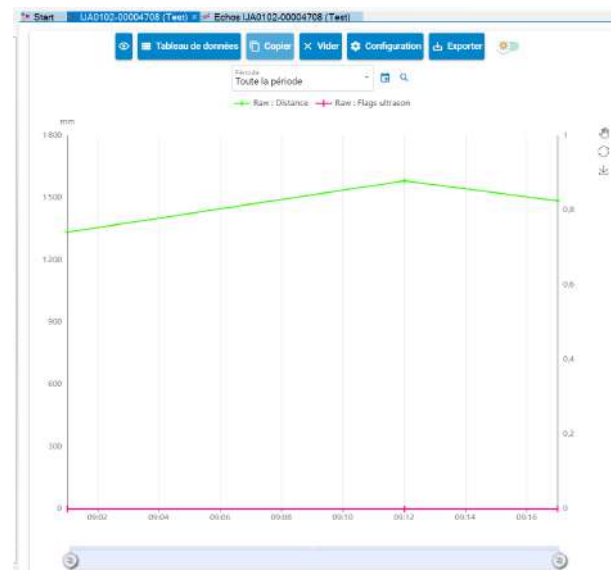
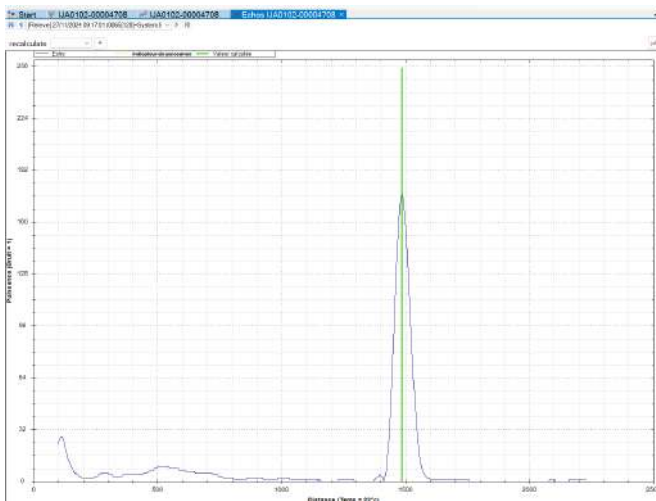



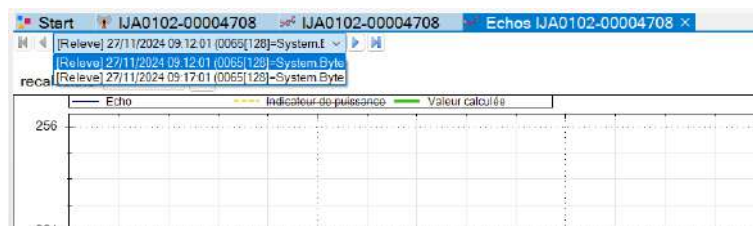





-> The recorded echo graph (chronologically first if several echoes have been recorded) and the measured data graph open.



- To select another saved echo, click in the top left-hand corner to display the list of saved echoes. By default, the number of recorded echoes is limited to 10 (configurable via the advanced "Recorded timestamps" parameter).



-> The files are saved and available in the "Saved data" window, under the relevant logger -> files - > Retrieval.

	 IJA0102-00004708	5/12/2025 4:5...	6/30/2025 ...
	 Configurations	5/12/2025 4:5...	6/30/2025 ...
			
	 Data		
	 Files	6/3/2025 7:15...	6/30/2025 ...
	 Retrieval (6/30...	6/3/2025 7:15...	6/30/2025 ...
			
	 File 202506...	6/3/2025 7:15...	6/30/2025 ...

10.3. Retrieve data from auxiliary memory



The data transmitted in SMS text messages are stored in the auxiliary memory of the device.
Data transmitted via FTP are stored in the main memory.

To retrieve data locally with a logger configured to send data in M2M:

- In the main Actions menu, click on Auxiliary measures (for SMS) > Retrieve measures.

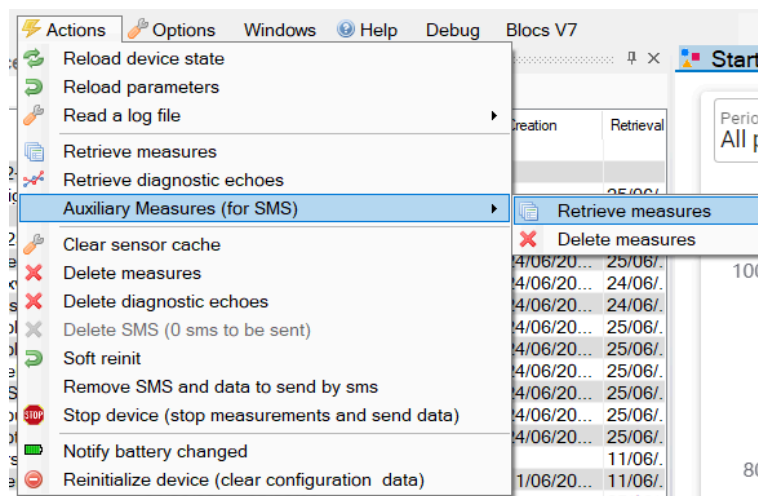

-> In the saved data window, the data retrieved appears in the browser structure.

10.4. Create a new calculated value

From the data retrieved in Avelour, it is possible to create new data values by applying a filter.

- In the saved data window, right-click on the base data for the new calculation.

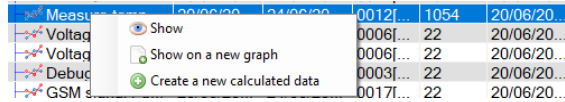

- In the Edit window, select a **filter type** among the four available:
 - Statistical filter
 - Time offset
 - Apply a conversion table
 - Drift correction

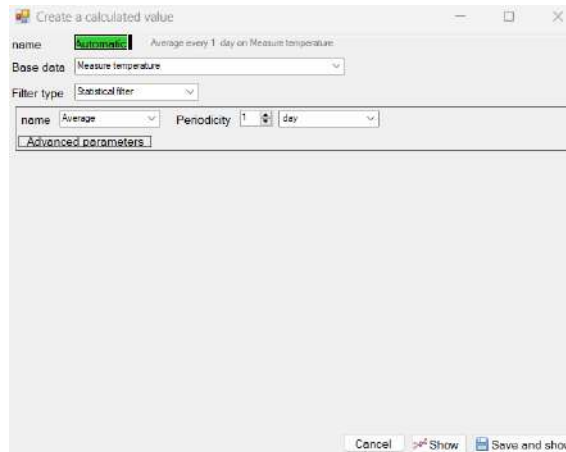
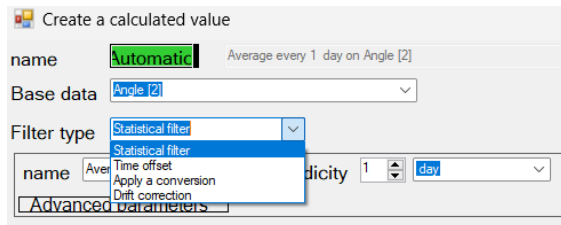

Edit window for a new calculated value - Calculation of the average daily temperature value





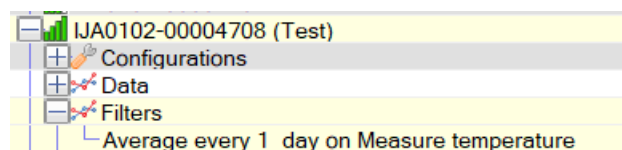







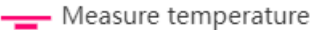

- Define contextual parameters based on the type of filter selected.
- Click “Save and show” to display the calculated value.

-> The calculated value appears in the saved data browser structure.



10.5. Data graph

10.5.1. Display tools on Avelour

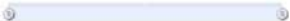
	Used to invert the display of the selected data, the hidden data is displayed and the displayed data is hidden.
	Used to display the table of all data below the graph.
	Used to copy data to the clipboard so that you can paste it.
	Used to clear the graph data.
	Used to access the graph display customization window. See Customize the graph display
	Used to export data in different types (Excel, leme, CSV, etc.) to a directory.
 Measure temperature	The data label allows you to display/hide it with a click.
 Measure temperature	
	Switches between day (light) and night (dark) display mode.
	Used to zoom in on the graph: Click and hold to select the area to enlarge.
	Used to move the cursor on the graph: click, hold click and move.
	Hold down the mouse wheel button to activate grabber mode.
	Used to restore the initial display of the graph.
	Used to export the graph as a PNG image.
	X-axis Zoom cursor.

10.5.2. Show data graph

In the Saved data window:

- Double-click on the data or select multiple data elements, right-click and click "View" to view the data as a graph.

	6/11/202...	6/24/202...		
Configurations	6/21/202...	6/24/202...		
Data	6/20/202...	6/24/202...		
Counter	6/20/202...	6/21/202...	0022[...	255
Total rainfall	6/20/202...	6/21/202...	0035[...	255
H2S Concentra...	6/20/202...	6/24/202...	0038[...	1054
Meas...	6/20/202...	6/24/202...	0012[...	1054
Volta	6/20/202...	6/21/202...	0006[...	22
Volta	6/20/202...	6/21/202...	0006[...	22
Debu	6/20/202...	6/21/202...	0003[...	22
GSM	6/20/202...	6/21/202...	0017[...	22
Duration days	6/21/202...	6/21/202...	0046[...	1
Voltage [2]	6/21/202...	6/21/202...	0006[...	2
Filters	6/11/202...	6/11/202...		
File	6/20/202...	6/24/202...		

-> The saved data viewing window opens.

10.5.3. Customize the graph display

In the saved data viewing window:

- Click the configuration button  to display the graph display properties editing window.

Graph configuration
✕

DATA
AXES

✔ Material height

+ Add a calculated data

- Remove data

Representation Type
 Line  Color

Unit
 mm

Symbol
 Aléatoire ?

Line type
 Standard

Filling

Line Width - 2 +

Linked axe : mm

Unbound axes

- 4 +
 Maximum fraction digits number

Graph configuration window

10.5.4. Hide the display of data on the graph

- To hide the display of a data item, click the data label at the top of the graph.

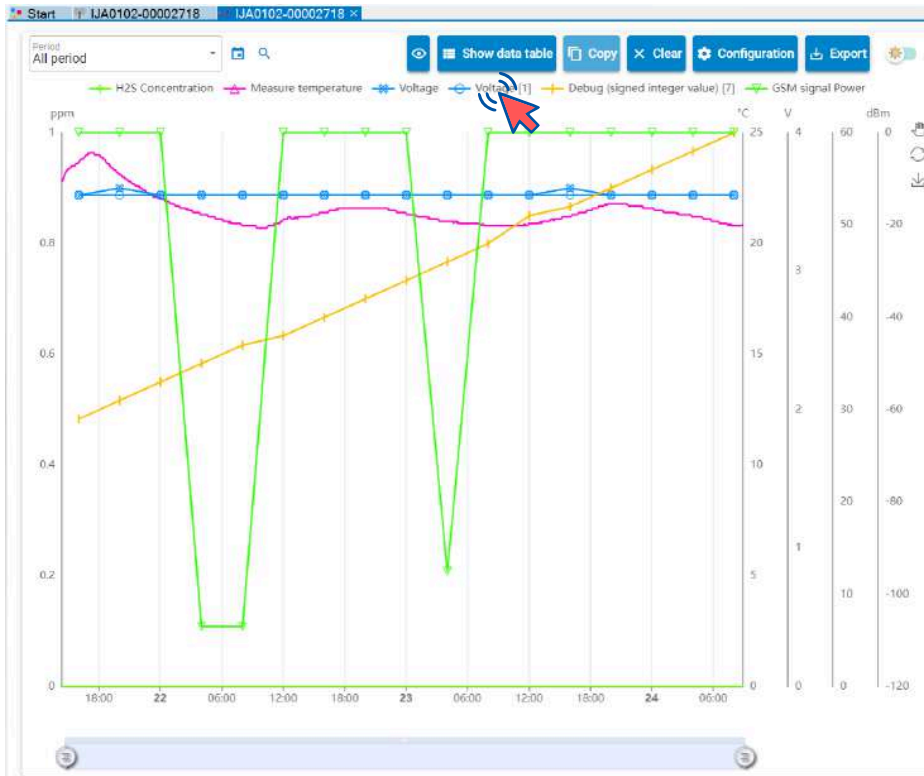

-> The data is no longer displayed on the graph and its label appears grayed out.

- Click the  button to invert the display, hide the displayed data and display the hidden data.

10.5.5. Display values in table form

In the saved data viewing window:

- Click the “Show data table” button.

-> Data are displayed below the graph.

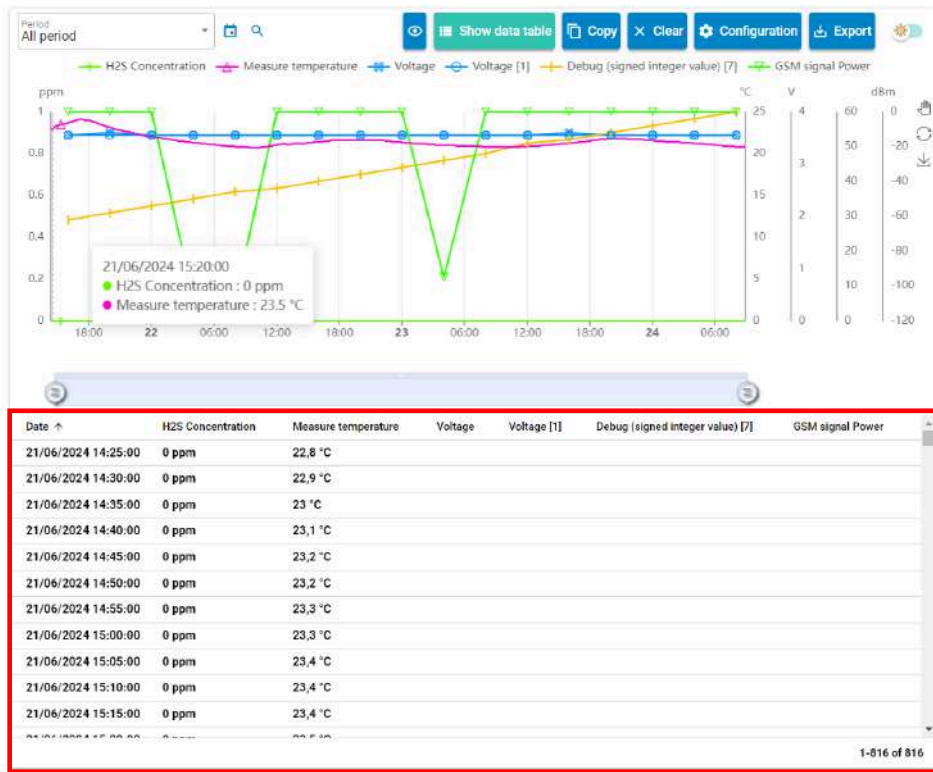

Data table

10.6. Export retrieved data



Data is retrieved in Avelour, see paragraph [Retrieving saved data](#) parameters.

- In the data viewing window, click on “Export”.
- Select the export type, the period and the export destination directory.

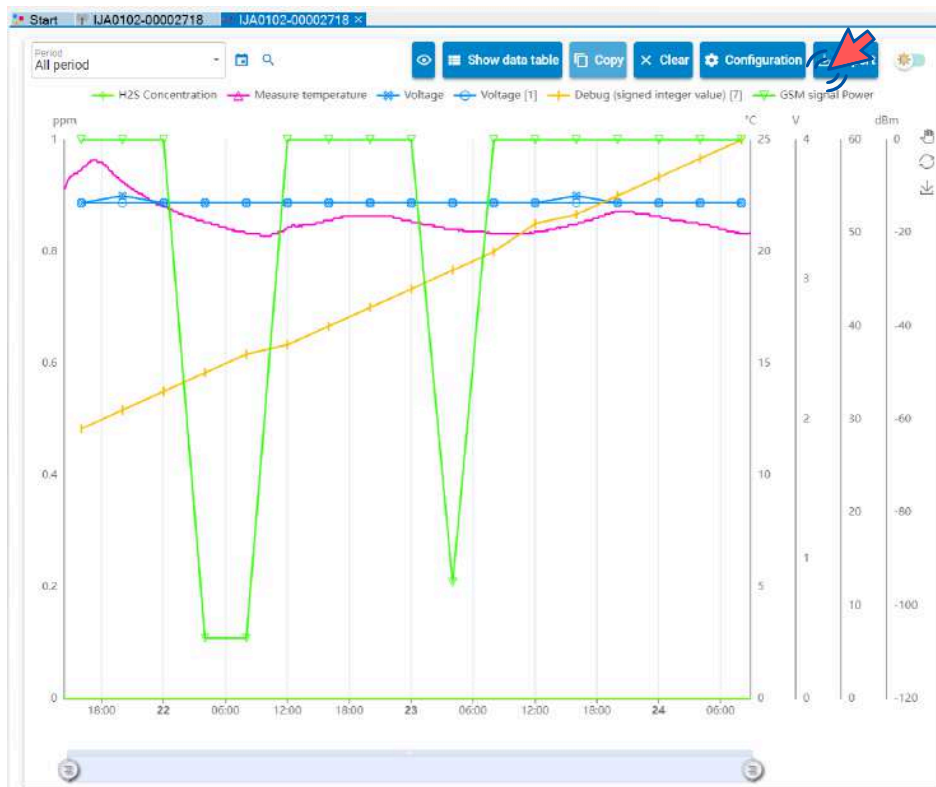

10.7. Delete data recorded on the logger

To delete data recorded on the logger memories:

- In the "Actions" menu, click "delete measures" to delete the main memory of the logger.

- In the "Actions" menu, click "delete measures" in the sub-menu "Auxiliary measures (for SMS)" to delete the auxiliary memory.

When connecting to a logger, if data is present, it is then possible to retrieve and delete data. The deleted data will then be that of the main memory.

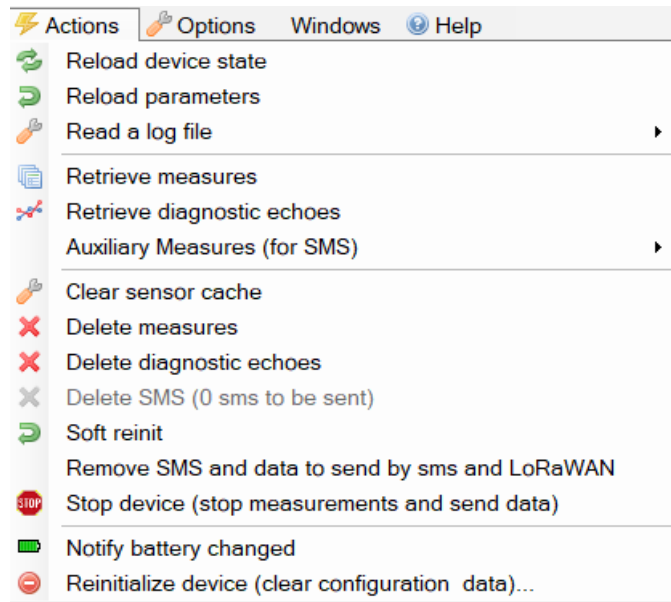

Chapter 11. Maintenance

In the event of a problem with an Ijinus recorder or sensor, we recommend that you contact our customer service department either by e-mail: sav@ijinus.fr or by telephone: +33 (0)298 090 332

You will be informed of the applicable procedure, so that you can either test the product yourself or return it to the factory for testing on our premises.

11.1. Replacing the battery

When the logger's battery is at the end of its life, a red banner appears on Avelour, inviting you to replace the battery.



Avoid leaving the logger open for too long (just a few minutes), because if the desiccant bag absorbs too much moisture, it will no longer be effective and will turn green.

- Unscrew the clamping ring (A) and remove the cover.
- Remove the battery and disconnect the circuit board.
- Check the color of the desiccant bags and replace them if they are green.
- Check the seal for damage.
- Check seal lubrication and if necessary, lubricate with neutral grease.
- Replace the cover as far as it will go, taking care to fit the insertion notch into the coded hole (B).

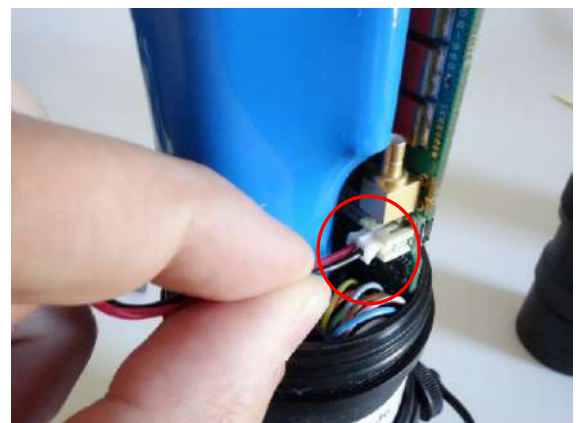

-> When the circuit board is restarted, the LED on the front of the board should flash red/green and then, after 2 to 3 minutes, only green every 10 seconds.

- In Avelour, click on "battery changed".

If the battery has been changed before the red banner appears, you must also record the battery change:

- Connect to the logger (see [Connecting to a logger](#)).
- In the actions menu, click on "report battery change" to restart the logger and return the energy gauge to 0.

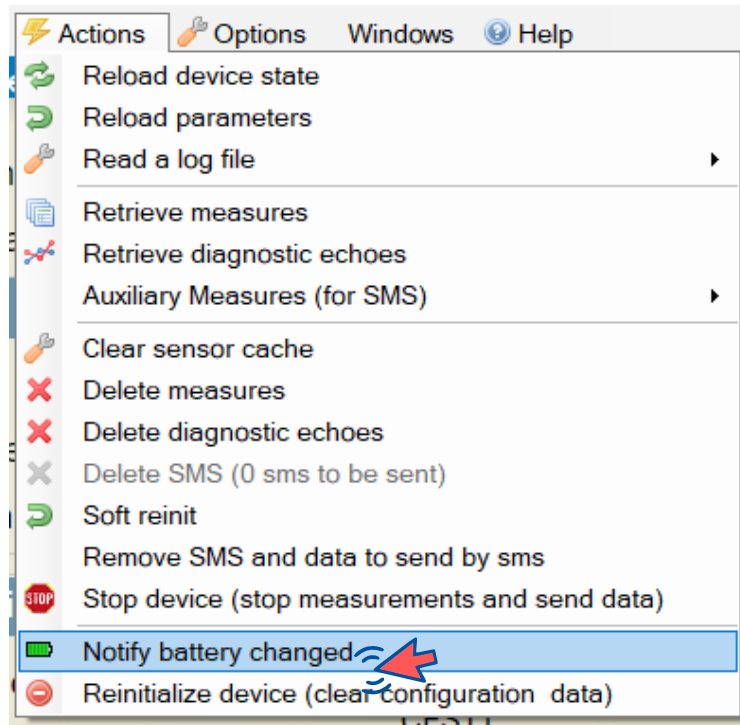

-> In the device properties window, the battery gauge changes to 0 mAh.

Diagnostic	
Date on device	2024-06-20 17:09:24 (+02h00 CEST)
Battery	3.6V
Gauge	0mAh
Free memory	1007200 / 3243616 (31%)
Aux data	1
Main data	0

11.2. Firmware update

A firmware update may be required when updating the Avelour programming software.

- Connect to the logger (see paragraph [Connecting to a logger](#)).
- In the "Options" menu, click on "Troubleshooting and errors".
- By connecting to the logger in advance, the choice of device (1) is already made. To change this choice, click "Device choice".
- In the list of actions to launch (2), select "Upgrade the device firmware".
- Click "Choose firmware".

-> The Firmware folder opens.

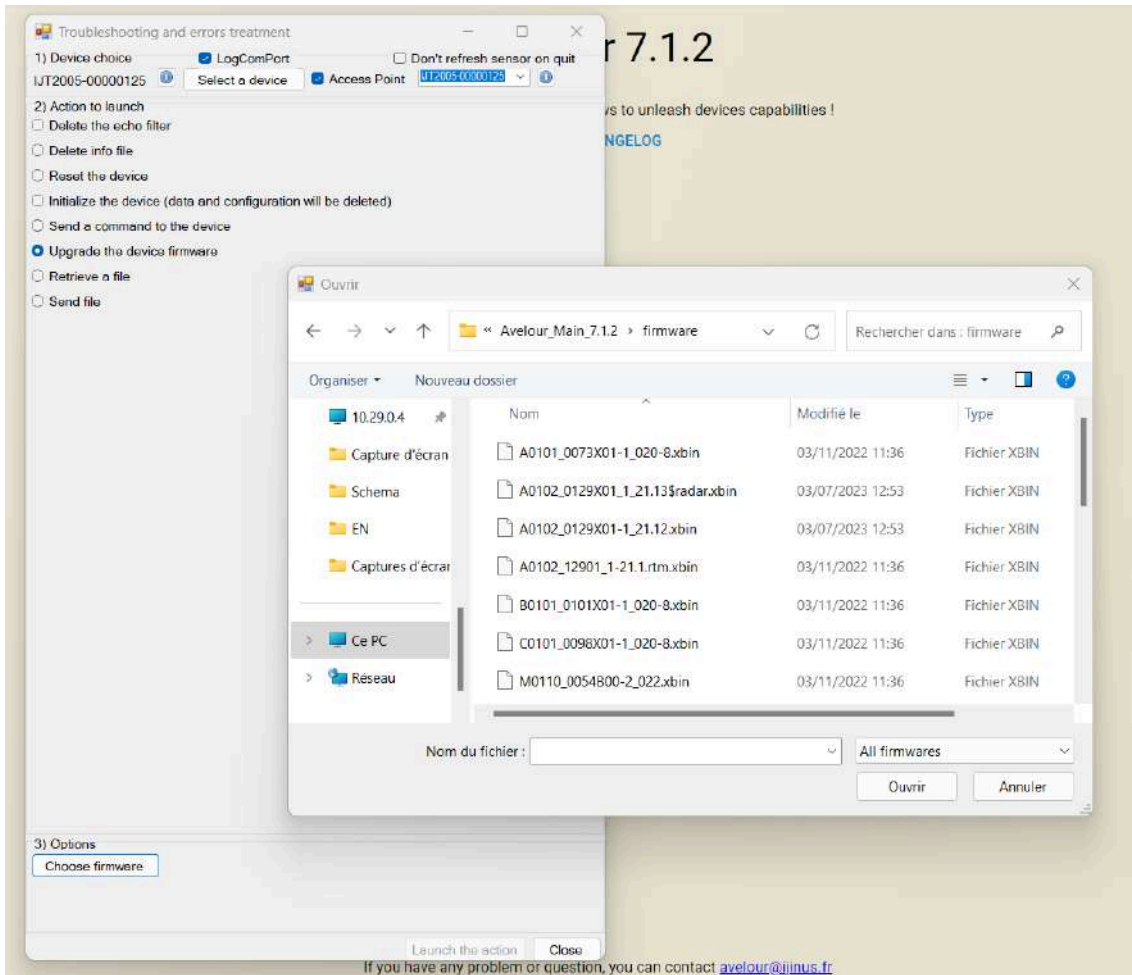

- Select the corresponding .xbin file and click "Launch the action" (3).

11.3. Remote firmware update



The logger must be equipped with a modem card and configured to send data via **FTP**, **HTTP** or **MQTT**.

If you are using the ijttrak server, contact Ijinus to obtain the identifiers and password and configure Avelour.

If using another server, contact Ijinus to obtain a version of Avelour enabling you to customize the server configuration.



Beware ! Remote firmware update and remote configuration can't be done simultaneously. Take care to launch one after the other.

- Hold down the CTRL key and select one or more loggers and right-click.
- Click on "Remote firmware update".

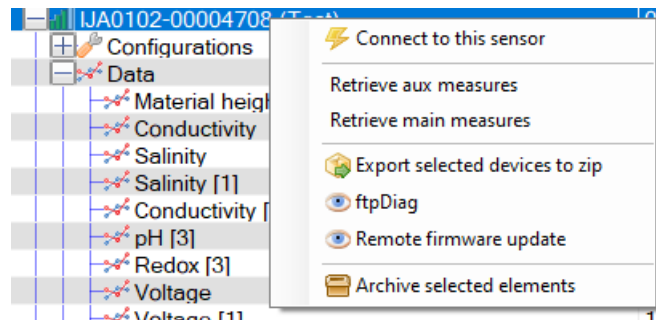

-> The update window opens and displays the firmware serial number(s), status, current version and new version.

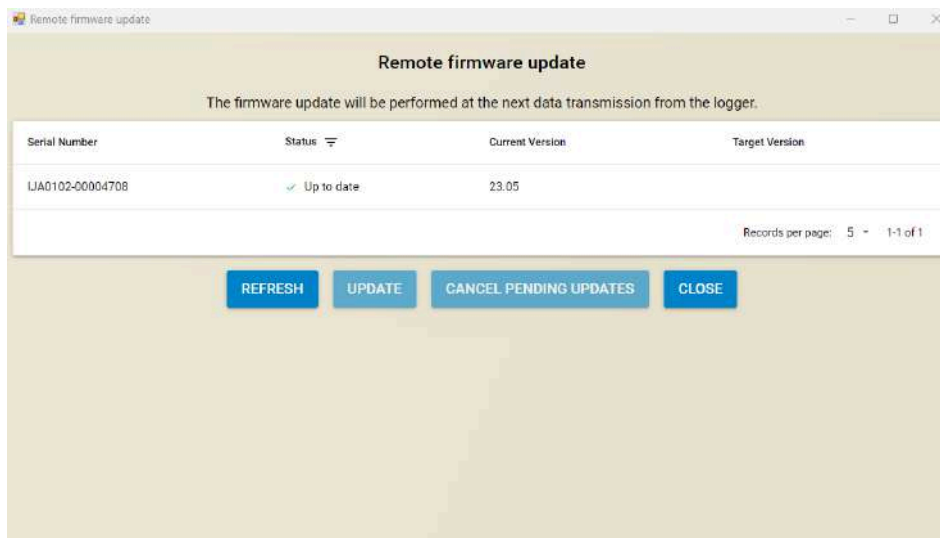

- Click "Update".

-> The update file is sent to the FTP server and the update will be performed during the next data transmission.

11.4. Reset the logger (factory settings)

The logger may need to be reset when a service request is made or if the password is forgotten.



The Reset process deletes all configuration files and data stored on the logger.

11.4.1. Wiji reset

- Connect to the logger (see [Connecting to a logger](#)).
- In the **Options** menu, click on **Diagnostics and errors**.
- Check that the serial number (1) corresponds to that of the logger.
- Check **Equipment reset (loss of data and configuration (2))**.
- Click on **Launch (3)**.

-> the logger formatting window appears.



Depending on the amount of data to be deleted, the reset process may take a few minutes.

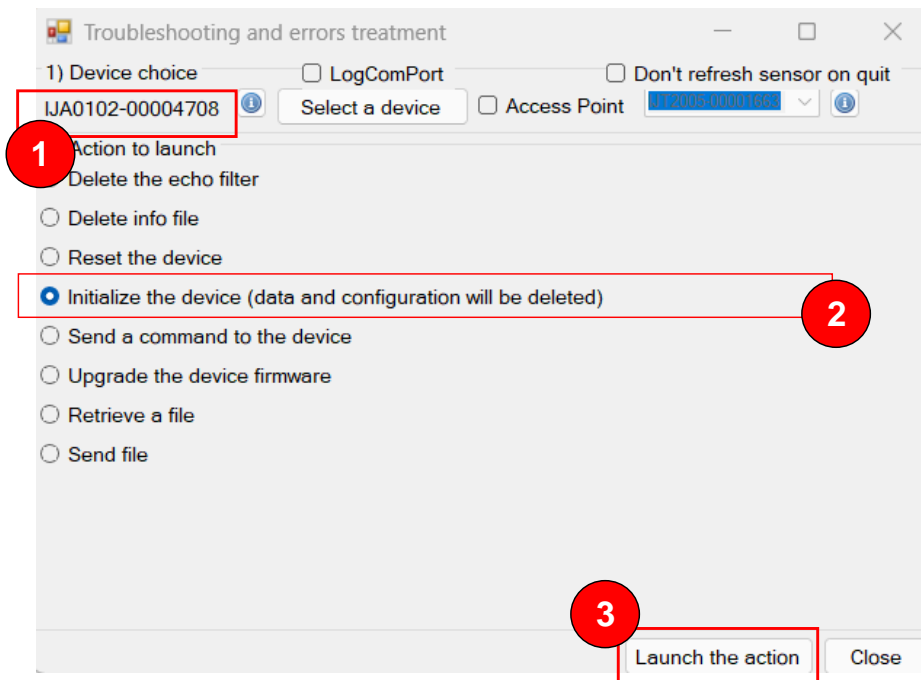

11.4.2. Manual reset



Avoid leaving the logger open for too long (just a few minutes), because if the desiccant bag absorbs too much moisture, it will no longer be effective and will turn green.



Removing the cover can be difficult due to the gasket. The cover antenna is connected to the circuit board, so to avoid pulling out the circuit board when opening the logger, we strongly advise you to open the logger as follows:

- Partially unscrew the clamping ring (approx. 2 turns).
- Pull on the cover until it is partially extracted, blocked by the clamping ring.
- Unscrew the clamping ring completely to fully remove the cover.
- To make it easier to press the buttons, we recommend removing the battery from its housing.
- Press the **SW (B)** button, then the **RST (A)** button, and release the **RST** button.
 - > The status LED (**C**) flashes red.
- When the LED changes to flashing green, release the **SW (B)** button.
 - > Reset starts.

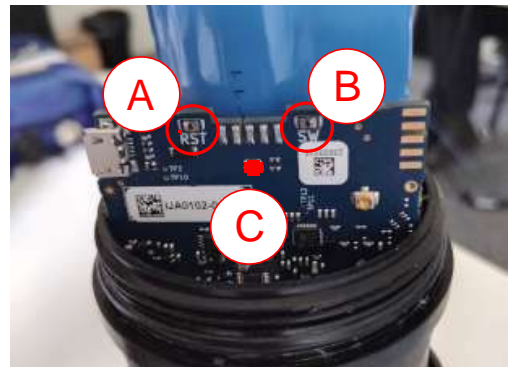

Depending on the amount of data to be deleted, the reset process may take a few minutes.

The LED resumes its initial flashing cycle (every 10 seconds in green) as soon as the reset is complete.