



iJiNUS
GROUPE CLAIRE

LOG09V4



Autonomous logger

User guide

User guide: Version 06

Publication date 04/2026

Documentation valid from Avelour software version 7.4.1

Table of Contents

1. Document information	8
1.1. Background	8
1.2. Symbols used	8
2. Product marking information	9
3. Safety	10
3.1. General instructions	10
3.2. Note for users in Canada	10
4. Product description	11
4.1. Principle of operation	11
4.2. Description	12
4.3. Technical specifications	13
4.3.1. Data logger	13
4.3.2. Dimensions	14
4.3.3. M12 8-pin connector	15
5. Commissioning	16
5.1. Inserting the SIM card	16
5.1.1. Releasing electrical charges	16
5.1.2. Inserting a SIM card	16
5.2. Assembling the modem 2G / 4G kit	17
6. Power supply	19
6.1. Using a mains power supply	19
6.2. Using a power pack	19
7. Connections	20
7.1. Wiring	20
7.1.1. Flow meter wiring in Modbus protocol	20
<i>Krohne Waterflux 3070</i>	21
<i>ABB Aqua master 4</i>	21
<i>Badger M5000</i>	22
<i>MAG8000</i>	22
<i>Octave</i>	23
<i>Proline Promag W 800</i>	24
7.1.2. C4E physical-chemical sensor	25
7.1.3. CTZN physical-chemical sensor	25
7.1.4. Redox Annulaire digital physical-chemical ring sensor	26
7.1.5. NTU Physical-chemical sensor	26

7.1.6. OPTOD physical-chemical sensor	26
7.1.7. PHEHT physical-chemical sensor	27
7.2. Connect one or more external sensors	27
7.3. Connecting a 2 wires sensor	28
7.4. Connecting a 3 wires sensor	28
7.5. Connecting a 3 wires sensor with a power supply	29
8. Installation	30
8.1. Installing a clamp	30
8.2. Installation with mounting kit	30
8.2.1. Installing a remote antenna	32
9. Configuration on Avelour	34
9.1. Equipment required	34
9.2. Installing the Avelour software	34
9.3. Connecting to a logger	34
9.4. Protect the logger using a password	37
9.4.1. Activation	37
9.4.2. Password Format	38
9.4.3. Forgotten password	38
9.5. General configuration information	38
9.6. Configuring a measurement recording	39
9.6.1. Intelligent low-power Doppler measurement (Ubertone sensor)	39
Principle	39
Configuration	39
Mapping table between DataID, channel & data	43
9.6.2. Water height measurement: Low-profile Doppler (IAVL sensor)	45
Principle	45
Configuration	45
Mapping table between DataID, channel & data	49
9.6.3. Doppler velocity measurement (Nivus sensor)	51
Principle	51
Configuration	51
9.6.4. Doppler velocity and overflow measurement (Nivus sensor)	53
Principle	53
Configuration	53
9.6.5. Flow measurement: Doppler speed + built-in piezoresistive height (Nivus sensor)	55
Principle	55
Configuration	55
Combined Doppler speed/piezoresistive height sensor	55
9.6.6. Conductivity measurement (B&C sensor)	58
Principle	58
Configuration	58
9.6.7. Physical-chemical measurement	60
Principle	60
Configuration	60
Mapping table between DataID, channel & data	65
9.6.8. Measurement using an ISCO signature flow meter	68
Principle	68

Configuration	68
Mapping table between DataID, channel & data	69
9.6.9. Measurement using the Modbus protocol : Slave mode	72
Principle	72
Settings	72
9.6.10. Modbus flow meter	74
Principle	74
Flowmeter wiring	74
Configuration	74
9.6.11. Measurement with a 4-20 mA piezoresistive sensor + external speed sensor	83
Principle	83
Configuration	83
9.6.12. Measurement via 4-20 mA input	88
Principle	88
Configuration	88
Correspondence chart between DataID, channel & data	94
9.7. Configuring the sending data	95
9.7.1. Technologies used	95
9.7.2. Signal quality: Mobile Signal Strength Value	95
9.7.3. Configuring the modem of the communication card	96
Technology to use	97
PIN code	97
APN	98
Priority operator (Multi-operator SIM)	98
Program modem	99
9.7.4. Check network quality: Modem diagnostics	100
9.7.5. Data sending in FTP(s)	101
9.7.6. Data sending in Http(s)	104
Configuration	104
9.7.7. Data sending in MQTT(s)	107
Principle	107
Message format	107
Activation	107
Configuration	108
Quality of Service (advanced setting)	108
Format Almviva	108
Topic (advanced setting)	109
9.7.8. Advanced internet connection settings	109
PPP	109
SNTP	109
Custom DNS server	110
9.7.9. Certificate management	110
Generalities	110
Managing certificate	111
9.7.10. Data sending via SMS	112
9.7.11. Data sending in LoRaWAN	114
Transmission cycle	114
Login information	114
Test data transmission	114
Advanced settings	115
Expert mode	115
Integration of a logger on Orange Live objects	115
Integration of a logger on WIOTYS	116
Integration of a logger on THE THINGS	116
9.7.12. Configure an alarm	118
9.7.13. Sending an alert SMS	118

9.8. Test data transmission before commissioning	119
9.8.1. Objective	119
9.8.2. Test procedure	119
9.8.3. Troubleshooting	119
9.9. Sending logger configuration using server (remote configuration)	120
9.9.1. Principle	120
9.9.2. Configuring server access on Avelour	121
FTP	121
HTTP	121
MQTT	122
9.9.3. Configuring data sending	123
FTP	123
HTTP	123
MQTT	124
9.9.4. Retrieving a configuration via internet	124
9.9.5. Edit and send the configuration remotely	126
9.9.6. Do a remote configuration of a logger without a communication card	127
9.10. Power supply configuration	128
9.10.1. Lithium battery	129
9.10.2. Lead-acid battery	130
9.11. Set time zone	130
9.12. Pairing one or more loggers	131
9.13. Check the status of data recording and transmission	132
9.14. Save the configuration to the logger	133
9.15. Visualize measured values in real time	134
9.16. Stop a recording in progress	134
9.17. Disconnect from the logger	135
9.18. Managing a configuration	135
9.18.1. View a configuration file	135
9.18.2. Archive a file	135
9.18.3. Create a configuration template	136
9.18.4. Apply a configuration template	136
10. Data management on Avelour	138
10.1. Retrieving saved data	138
10.2. Retrieve data from auxiliary memory	139
10.3. Create a new calculated value	141
10.4. Data graph	142
10.4.1. Display tools on Avelour	142
10.4.2. Show data graph	142
10.4.3. Customize the graph display	143
10.4.4. Hide the display of data on the graph	144
10.4.5. Display values in table form	144
10.5. Export retrieved data	146
10.6. Delete data recorded on the logger	146

11. Maintenance	148
11.1. Replacing the battery	148
11.2. Firmware update	150
11.3. Remote firmware update	151
11.4. Reset the logger (factory settings)	152
11.4.1. Wiji reset	152
11.4.2. Manual reset	153

Chapitre 1. Document information

1.1. Background

This user guide contains all the information required to install, connect and commission the unit, as well as important notes concerning maintenance. It is therefore essential to read it before commissioning any Ijinus equipment.

1.2. Symbols used



This symbol indicates a situation or use that may result in damage, fault or equipment malfunction.



This symbol indicates additional information useful for the understanding and correct use of the equipment.



This symbol indicates a prerequisite for performing a task.

Chapter 2. Product marking information



The CE mark indicates that the product complies with current European directives.



Consult the user manual before using the product.



Do not dispose of this product in household waste. The product must be sent to a specific collection point, or collected by an organization that will ensure its further processing.



Direct current

Meaning of symbols

Chapter 3. Safety

3.1. General instructions

This document presents a number of operations and programming to be performed on a data logger, a sensor or an accessory supplied by Ijinus. These operations must only be performed by personnel qualified to use Ijinus products. The information provided in this user guide only ensures operational safety if the equipment is used correctly. Performing any work on the device requires the use of appropriate personal protective equipment. Below we have provided a non-exhaustive list of recommendations to apply to ensure the safety of Ijinus data logger users:

- Only use batteries specified by Ijinus.
- Risk of fire or burns with lithium batteries: do not short-circuit, recharge, puncture, incinerate, crush, immerse, fully discharge or expose the batteries supplied by Ijinus to temperatures above the operating temperature range.
- Do not shake the sensor.
- Do not physically modify the sensor.
- Do not clean the device with an aggressive product, particularly Acetone and similar.
- The device contains components that may be damaged or destroyed by electrostatic discharge. Release any electrostatic charge from your body before opening the device and handling it. To do this, touch a grounded metal surface. Ijinus assumes no liability for damage resulting from incorrect or non-compliant use.

3.2. Note for users in Canada

This device complies with Industry Canada's RSS for license-exempt radio equipment.

The operation is authorized subject to the following two conditions: (1) it must not cause interference, and (2) the user of the device must be prepared to accept any radio interference received, even if this interference is likely to compromise the operation of the device.

In accordance with Industry Canada regulations, this radio transmitter may be operated with an antenna of a type and maximum gain (or less) approved for the transmitter by Industry Canada.

To reduce the risk of radio interference to other users, the type of antenna and its gain must be chosen so that the equivalent isotropically radiated power (e.i.r.p.) does not exceed the intensity required to establish satisfactory communication.

This device complies with the RF personal exposure requirements defined by Industry Canada. This device must be installed so as to provide a separation distance of at least 20 cm from the user, and must not be installed near or used in conjunction with any other antenna or transmitter.

If the antenna is removable (RSS-GEN): This device has been designed to work with the antennas listed below, with a maximum gain of 0 dBi. Antennas not included in this list, or with a gain exceeding 0 dBi, are strictly forbidden for use with this device. The required antenna impedance is 50 Ω . List of acceptable antennae:

- IJINUS
- BOE type

Chapter 4. Product description

4.1. Principle of operation

Ijinus loggers are designed to be standalone units powered by a lithium battery. They log data transmitted by the equipment to which they are connected. A mobile programming unit (M0C00001) or a Wiji USB dongle (WIJKEY-8) can be used to connect to the logger by radio (Wiji protocol), configure it and retrieve data locally. Depending on the logger model, it can be fitted with a modem, enabling data to be transmitted automatically and wirelessly to our Web platform www.ijitrack.com, or to a client server.

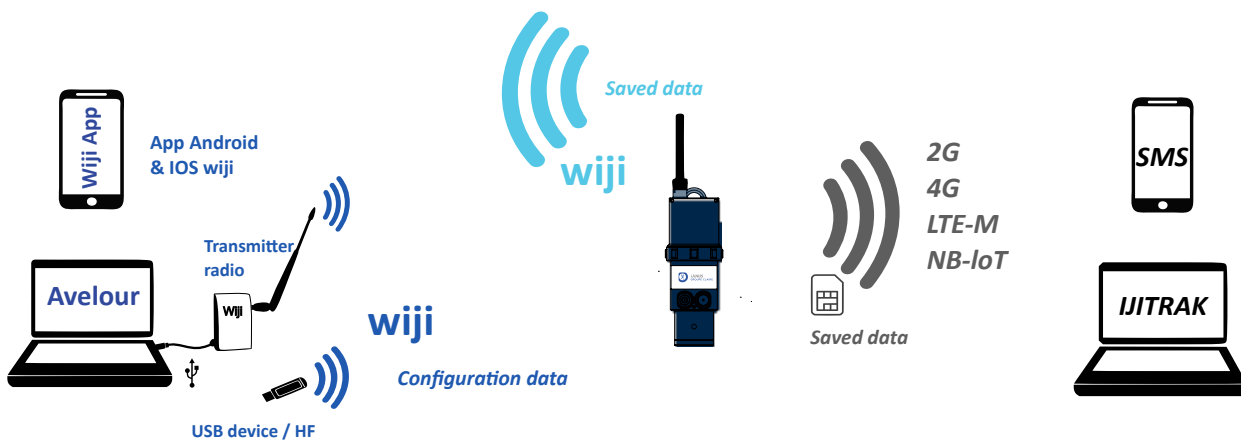

4.2. Description

The logger is powered by an internal battery. The logger housing has an IP68 waterproof rating (can be submerged in 10 meters of water for 30 days).

A radio access point, also called a programming antenna, must be used to program the logger. This access point can also be used for contactless, local data transfer (maximum of a few dozen meters between the logger and the access point connected to a computer's USB port).

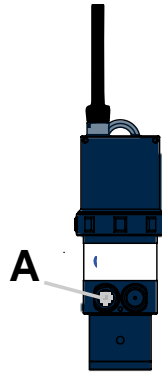

LOGV4 logger



3.6 V 34 Ah non-rechargeable lithium battery



Programming antenna





Remote antenna (optional)



Mounting kit: 2 x mounting plates + 1 x bracket + 4 nuts and bolts

4.3. Technical specifications

4.3.1. Data logger

Features	LOG09V4-82-LTE (868 MHz) LOG09V4-92-LTE (915 MHz)
Data logger	500,000 measures
Concentrator	Yes
Inputs	1 Voltage input (5V - 30V) 1 Modbus input (if not used as output) 2 Current inputs (4-20 mA)
Outputs	HF radio (868 or 915 MHz) 2G / LTE-M / NB-IoT 1 Voltage output (5V-18V on internal battery or Vin switch) 1 Open Collector Output 1 Modbus output (if not used as input)
Radio communication	100M free-field (Wiji protocol)
Radio / mobile antenna	Internal or external radio - External mobile See configurator for options overleaf
Temperature range	-40°C to 85°C
Data logger material	PA12
Ingress protection	IP68 (only if using Ijinus mounting kit; P/N: H0T00053 or H0T00060)
Power supply	Battery: 3.6V 34Ah
Configuration	Wireless Programming Kit (PN: M0C00001) integrating AVELOUR software
Atex zone 2 certification	II 3G Ex ic ec IIB T4 Gc Ambient temp: -20°C to 60°C
Certifications	  : SE6A002-A0102 / IC: 10983A-A002-A0102



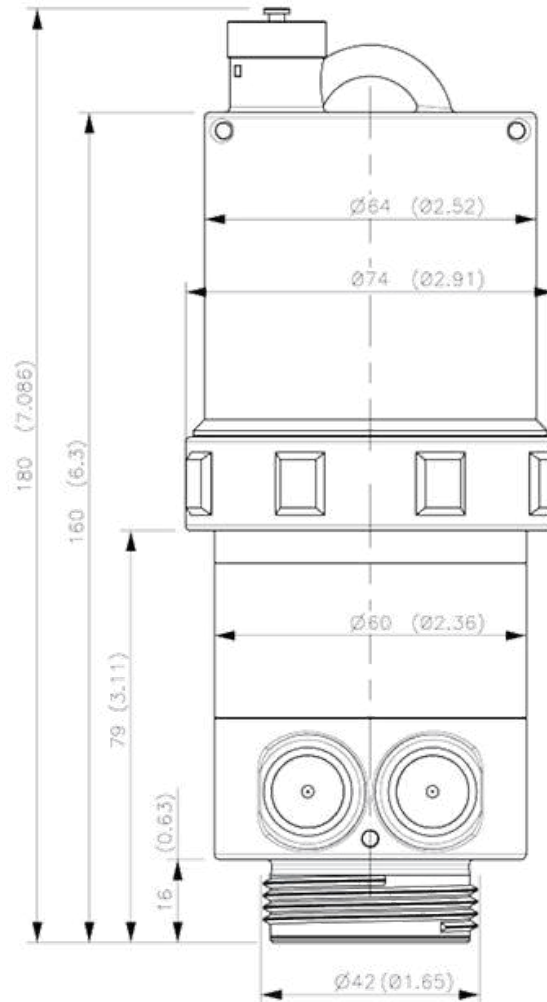



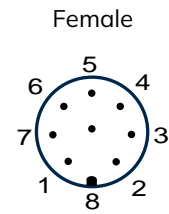
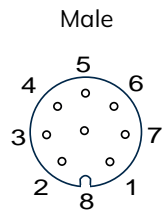

4.3.2. Dimensions



4.3.3. M12 8-pin connector

Wiring



Cable color	White 	Brown 	Green 	Yellow 	Grey 	Pink 	Blue 	Red 
8-pin connector: No.	1	2	3	4	5	6	7	8
Name	Vin	GND	Vout	Input OR Output	Input OR Output	Input	Input	Output Open-Drain
Features	(5V to 30V)	Ground	5V to 18V * (internal battery) or Switch Vout = Vin	RS485-H	RS485-L	Current 1	Current 2	Contact Grounding
Type	Power supply input		Power supply output	Modbus	Modbus	4 - 20 mA	4 - 20 mA	Open drain (1A/30V)

* Maximum 1.8 W on V_{out} if the connected sensor is powered by the internal battery (voltage adjustable via software).

Chapter 5. Commissioning

If the logger does not have a communication PCB, there is no need to open the housing as the internal battery is already connected to the PCB. The logger is therefore operational immediately.

iJinus loggers do not require activation, as they listen for a radio connection request from a radio access point or another logger every 10 seconds.

If the logger has a communication PCB (LTE option, for example), then the SIM card must be inserted in its holder, see paragraph [Inserting the SIM card](#).

5.1. Inserting the SIM card

Loggers with a communication PCB require a SIM card to operate. The SIM card holder is located on the communication PCB.

5.1.1. Releasing electrical charges

Our sensors and loggers contain components that can be damaged by electrostatic discharge.



It is imperative to release any static electricity from your body before opening the product.

To do so:

- Touch a grounded surface such as an electrical cabinet enclosure

5.1.2. Inserting a SIM card



Avoid leaving the logger open for too long (just a few minutes), because if the desiccant bag absorbs too much moisture, it will no longer be effective and will turn green.



Removing the cover can be difficult due to the gasket. The cover antenna is connected to the circuit board, so to avoid pulling out the circuit board when opening the logger, we strongly advise you to open the logger as follows:

- Partially unscrew the clamping ring (A) (approx. 2 turns).
- Pull on the cover until it is partially extracted, secured by the clamping ring.
- Unscrew the clamping ring completely to fully remove the cover.
- Insert the SIM card into the SIM card holder, ensuring that it is inserted with the beveled side to the top right.
- Check the color of the desiccant bags and replace them if they are green.



- Replace the cover as far as it will go, taking care to fit the insertion notch into the coded hole (B).



- Retighten the clamping ring (A).

5.2. Assembling the modem 2G / 4G kit

Unscrew the clamping ring and remove the cover



Put the communication card



Replace the desiccant sachet with a new one.



Insert the male connector (A) of the antenna cable into the hole (B) and connect it to the card via the female connector (C)

Replace the cover, pushing it all the way in, taking care to ensure that the insertion notch is correctly aligned with the pin (D)

Screw the antenna to the cover

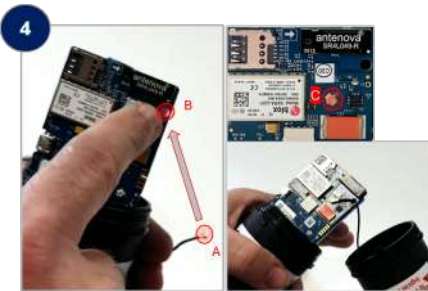

Chapter 6. Power supply

6.1. Using a mains power supply

Ijinus loggers can be powered from an external mains supply. The voltage delivered to the logger must be between 8 V and 30 V.



You must use a transformer (e.g. 220 V / 24 V) that is correctly grounded. In the absence of a ground connection, several malfunctions may occur (metering problems, measurement disturbances, etc.) due to disturbances caused by the mains power supply.

- To configure the logger, please refer to paragraph [Power supply configuration](#).

6.2. Using a power pack

Two main types of batteries are available from Ijinus:

- Rechargeable lead-acid battery.
- Non-rechargeable lithium battery.

Lead-acid batteries have a voltage of 12 V.

Two types of lithium batteries are available: 10.8 V and 14.4 V.



Do not use a 14.4 V battery on a sensor other than the Nivus Doppler.

Applying a voltage above 13 V to an Aqualabo sensor will disable the sensor.

- To configure the logger, please refer to paragraph [Power supply configuration](#).

Chapter 7. Connections

7.1. Wiring



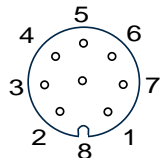



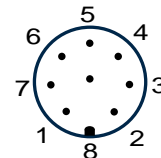

Wiring



Female



Male

Cable color	White	Brown	Green	Yellow	Grey	Pink	Blue	Red
								
8-pin connector: No.	1	2	3	4	5	6	7	8
Name	Vin	GND	Vout	Input OR Output	Input OR Output	Input	Input	Output Open-Drain
Features	(5V to 30V)	Ground	5V to 18V * (internal battery) or Switch Vout = Vin	RS485-H	RS485-L	Current 1	Current 2	Contact Grounding
Type	Power supply input		Power supply output	Modbus	Modbus	4 - 20 mA	4 - 20 mA	Open drain (1A/30V)

* Maximum 1.8 W on V_{out} if the connected sensor is powered by the internal battery (voltage adjustable via software)

7.1.1. Flow meter wiring in Modbus protocol



For the flowmeter to operate correctly in the Modbus protocol of communication (see paragraph [Measurement using the Modbus protocol : Slave mode](#), the ground must be wired.

Krohne Waterflux 3070

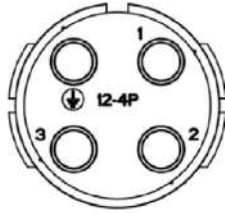

External side view connector

Flowmeter connector	wire Color	Function	M12 12 pts connector
1	Grey	RS485 L	8
2	Yellow	RS485 H	6
3	NC	/	NC
4	Brown	GND	1

ABB Aqua master 4

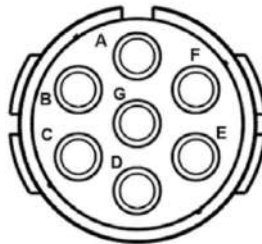

External side view connector

Flowmeter connector	Color	Function	M12 12 pts connector
A	Grey	RS485 L	8
B	Yellow	RS485 H	6
C	-	/	-
D	-	/	-
E	-	/	-
F	-	/	-
G	Brown	GND	1

Badger M5000

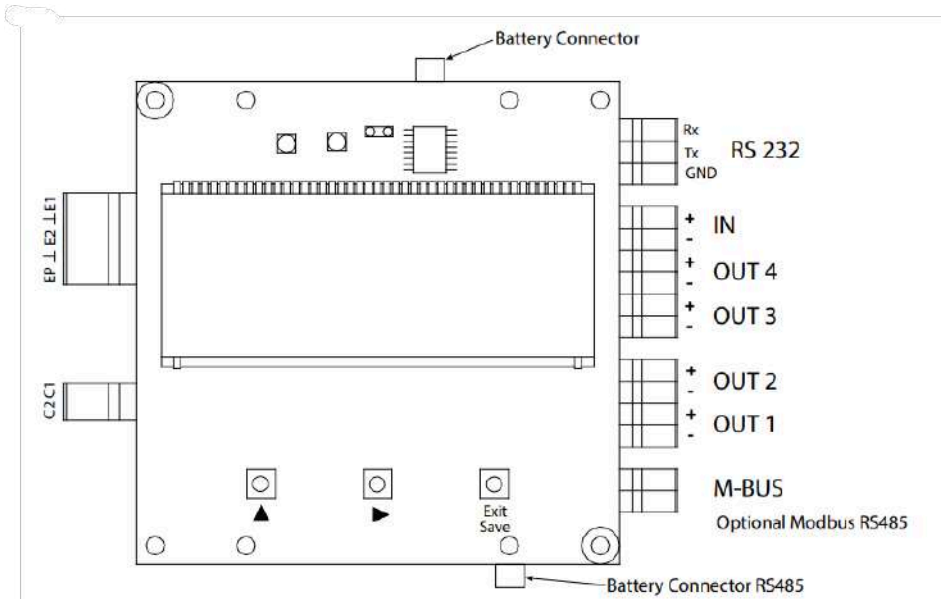

Input/Output	Description	Terminal
Output 1	Passive maximum 30V DC, 20 mA Maximum frequency 100 Hz	OUT1 (+) and (-)
Output 2	Passive maximum 30V DC, 20 mA Maximum frequency 100 Hz	OUT2 (+) and (-)
Output 3	Passive maximum 30V DC, 20 mA Maximum frequency 100 Hz	OUT3 (+) and (-)
Output 4	Passive maximum 30V DC, 20 mA Maximum frequency 100 Hz Can be used with digital input as an ADE interface.	OUT4 (+) and (-)
RS232	Modbus RTU	RxD, TxD, GND
IN	Digital input 3...35V DC	IN (+) and (-)
M-Bus ¹	M-Bus interface	No polarity
Optional Modbus RS485 ²	Modbus Interface Powered external 5...32V DC Optional internal by battery	GND, B-, A+, 12V

Flowmeter connector	Color	Function	M12 12 pts connector
A+	Yellow	RS485 H	4
B-	Grey	RS485 L	5
GND	Brown	GND	2

MAG8000

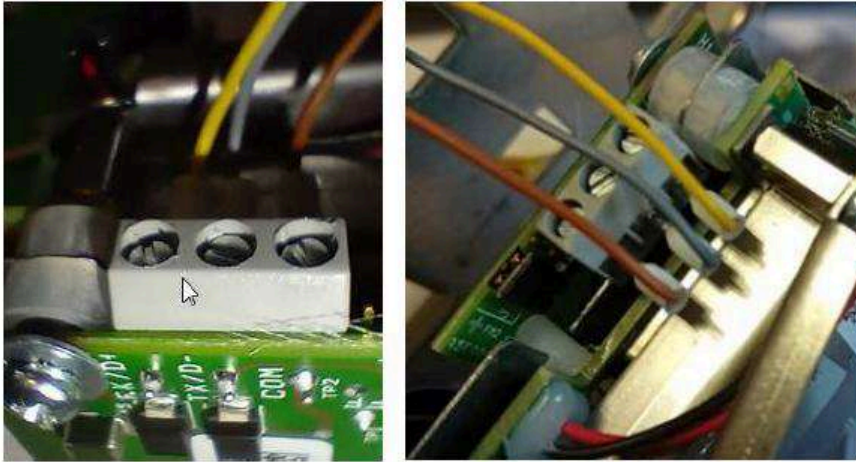

D+ : RS485 High (A) – IJINUS fil jaune
 D- : RS485 Low (B) - IJINUS fil gris
 COM : GND (fonctionne sans câblage de la masse) - IJINUS fil marron

Flowmeter connector	Color	Function	M12 12 pts connector
D+	Yellow	RS485 H	4
D-	Grey	RS485 L	5
GND	Brown	GND	2

Octave

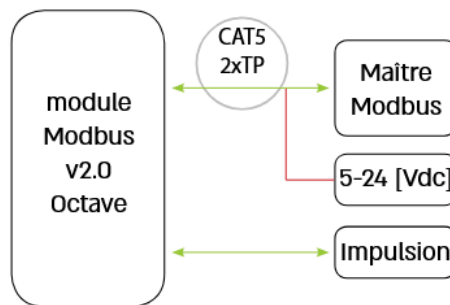

Câbles

	Fil	Fonction
ModBus	Bleu	D0/A/Tx+
	Blanc/Bleu	D1/B/Tx-
	Orange	5-24Vdc
	Blanc/Orange	Ground
Impulsion*	Rouge	Sortie impulsion
	Noir	Ground

MAG8000	Octave wire cable	IJINUS wire cable	Function	Pts connecteur M12 12 pts
Tx+	Blue	Yellow	RS485 H	4
Tx-	Blue/White	Grey	RS485 L	5
GND	Black	Brown	GND	2

Proline Promag W 800

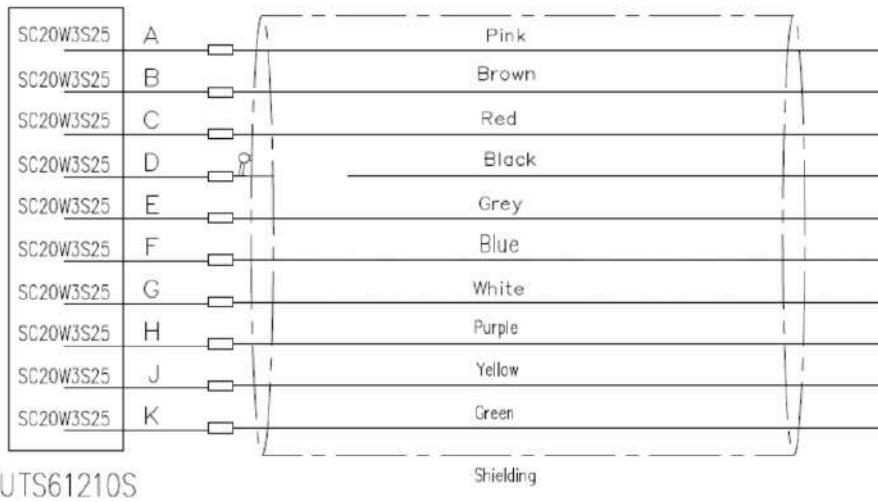
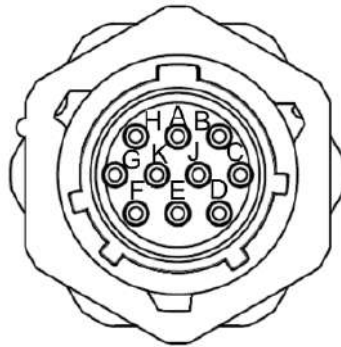

Broche	Fonction
A	PSO1+ (sortie impulsion/état 1+)
B	COM (potentiel de référence sorties impulsion/état)
C	NC (non connectée)
D	Terre
E	RS485_+ (Modbus B)
F	RS485_- (Modbus A)
G	PSO3+ (sortie impulsion/état 3+)
H	PSO2+ (sortie impulsion/état 2+)
J	NC (non connectée)
K	NC (non connectée)

MAG8000	IJINUS wire color	Fonction	M12 12 pts connector pts
E	Yellow	RS485 H	4
F	Grey	RS485 L	5
B	Brown	GND	2

7.1.2. C4E physical-chemical sensor

Wiring

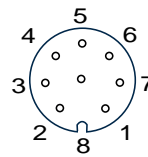

Female

Cable color	Black	Red	White	Green
8-pin connector	2	3	4	5
Name	V _{in}	GND	Modbus	Modbus
Features	Power supply	Ground	RS485 H	RS485 L

7.1.3. CTZN physical-chemical sensor

Wiring

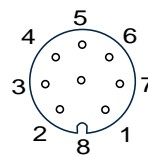

Female

Cable color	Black	Red	White	Green
8-pin connector	2	3	4	5

Name	V _{in}	GND	Modbus	Modbus
Features	Power supply	Ground	RS485 H	RS485 L

7.1.4. Redox Annulaire digital physical-chemical ring sensor

Wiring

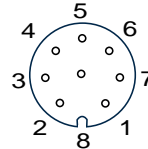

Female

Cable color	Black	Red	White	Green
8-pin connector	2	3	4	5
Name	V _{in}	GND	Modbus	Modbus
Features	Power supply	Ground	RS485 H	RS485 L

7.1.5. NTU Physical-chemical sensor

Wiring

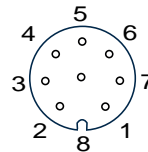

Female

Cable color	Black	Red	White	Green
8-pin connector	2	3	4	5
Name	V _{in}	GND	Modbus	Modbus
Features	Power supply	Ground	RS485 H	RS485 L

7.1.6. OPTOD physical-chemical sensor

Wiring

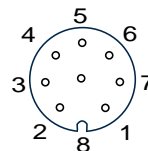

Female

Cable color	Black	Red	White	Green
8-pin connector	2	3	4	5

Name	V _{in}	GND	Modbus	Modbus
Features	Power supply	Ground	RS485 H	RS485 L

7.1.7. PHEHT physical-chemical sensor

Wiring

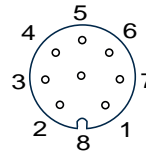

Female

Cable color	Black	Red	White	Green
8-pin connector	2	3	4	5
Name	V _{in}	GND	Modbus	Modbus
Features	Power supply	Ground	RS485 H	RS485 L

7.2. Connect one or more external sensors

The logger has an M12 8-pin socket for connecting different types of sensors or equipment.

To connect a sensor to the logger's M12 8-pin socket:

- Remove the protective cap, then screw the sensor onto the connector.



To ensure an IP68 waterproof seal on the connector, ensure that the connector is correctly screwed onto the base unit. To do this, tighten the connector to the base as far as possible, by hand and without tools.

If several sensors are to be connected to the logger, a junction box is available (part no. G0D00050) for IP68 compliant connection (provided all connectors are tightened correctly).

- Connect the male connector of the junction box to the logger base socket, then 3 sockets are then available on the junction box to connect sensors.

7.3. Connecting a 2 wires sensor

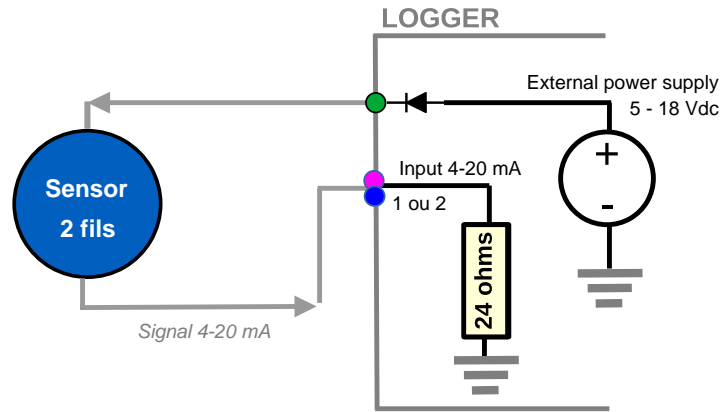

7.4. Connecting a 3 wires sensor

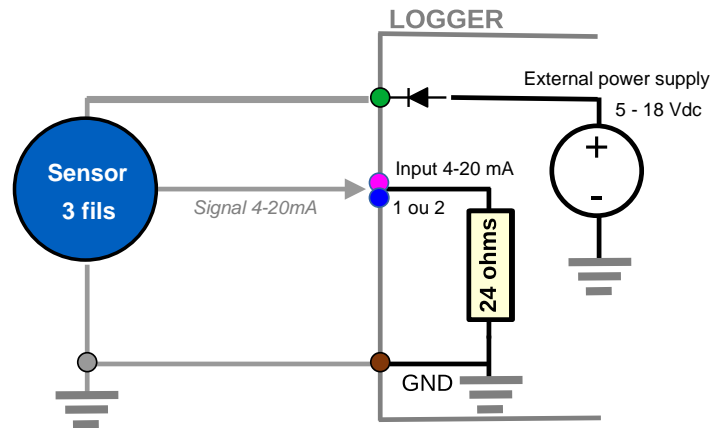

7.5. Connecting a 3 wires sensor with a power supply

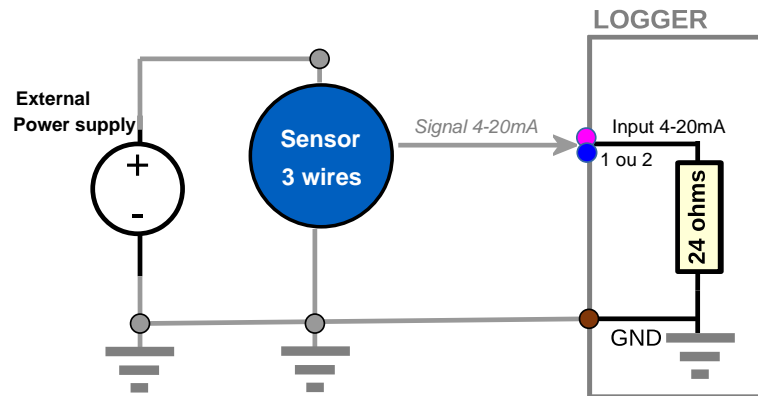

Chapter 8. Installation

8.1. Installing a clamp

To fit the Ijinus clamp:

- Position the clamp so that the Ijinus logo is aligned with the logger logo.
- To remove the clamp, insert a screwdriver into the notch (A) and pry the clamp loose.



8.2. Installation with mounting kit



Kit contents: 2 x mounting plates + 1 x bracket + 4 nuts and bolts



Assembled kit version 1



Assembled kit version 2



Example of installation with a mounting plate



Example of installation with two mounting plates

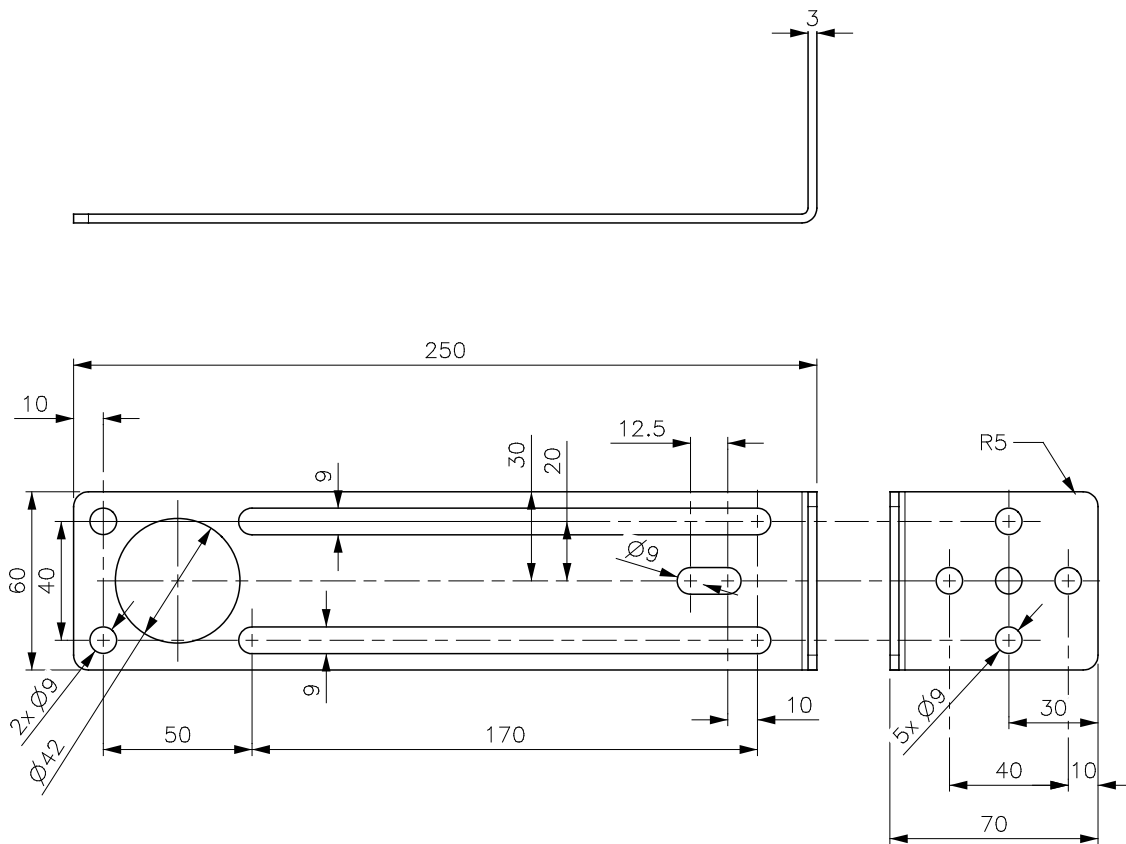

Mounting plate dimensions

8.2.1. Installing a remote antenna

The use of a remote antenna is useful if the logger is installed in a manhole with a buffer. In this case, connection to the logger may not be possible.

You must use an Ijinus remote antenna. Three lengths are available as standard: 1, 3 or 5m. In exceptional cases, a length of 10m may be proposed.

The antennas are suitable for sewerage network applications with a thick cable and reinforced sealing

- Connect the antenna to the sensor by screwing it **firmly** by hand and all the way to ensure a good seal.
- Identify the best conditions for installing the antenna, particularly the drilling direction for the best communication quality. A positioning and data transmission test is available in the Avelour software. You must do this test before and after installation (cover closed in the case of a manhole).
- Drill so that the antenna is outside the base area.

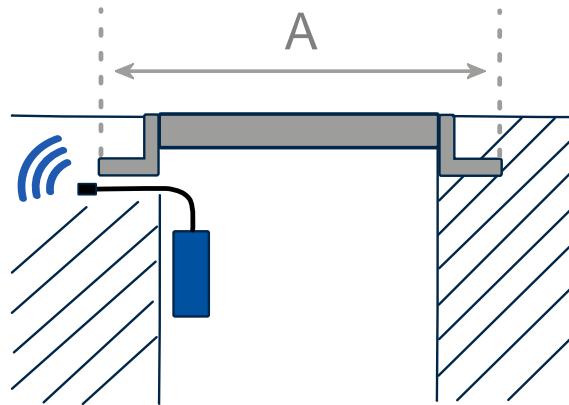

- Test positioning and data transmission using the Avelour software. This test should be carried out before and after installation (closed plug in the case of a manhole).



Drilling into the manhole

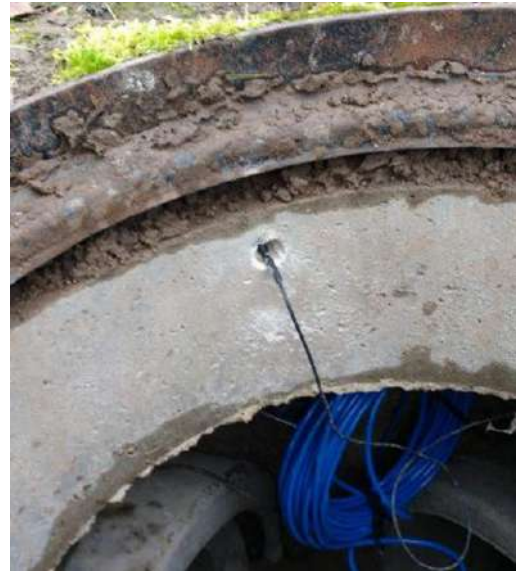

Inserting antenna under the base

Chapter 9. Configuration on Avelour

9.1. Equipment required

- Avelour software version 7.1 or later.
- A Wiji radio antenna in “long range” or “USB device” format.

9.2. Installing the Avelour software

The Avelour software can be downloaded from the IjInus website (www.ijinus.com) in the “Download” section.

- To install it in the background, open the Avelour software via the command line interface using space + /S after its name.

Example: `Setup_Avelour_7.1.2-Signed.exe /S`

9.3. Connecting to a logger

- Connect the Wiji radio access point and its antenna (or the Wiji USB device) to your computer’s USB port.

If the Wiji USB device is not detected:

- Remove the USB device from the port, reboot the PC and reinsert the device.
- If the device is still not detected, remove it and reinstall the drivers.

```
C:\Program Files (x86)\IjInus\Avelour_7.1.2\Driver
```

- Restart the PC and reinsert the USB device.
- Position your Wiji antenna at least one meter from the logger.
- Open the Avelour software.
- Open the logger selection window by clicking on “Connect to a wireless device”.



- Select the logger identified by its serial number (refer to its nameplate) and click “OK”.



Location of serial number

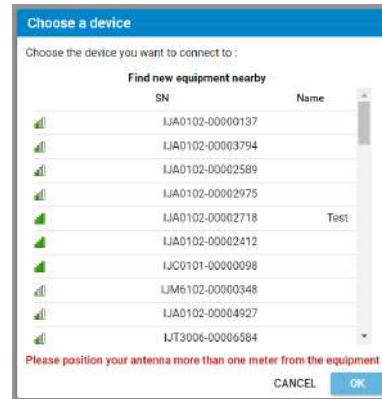

-> The logger configuration window opens.

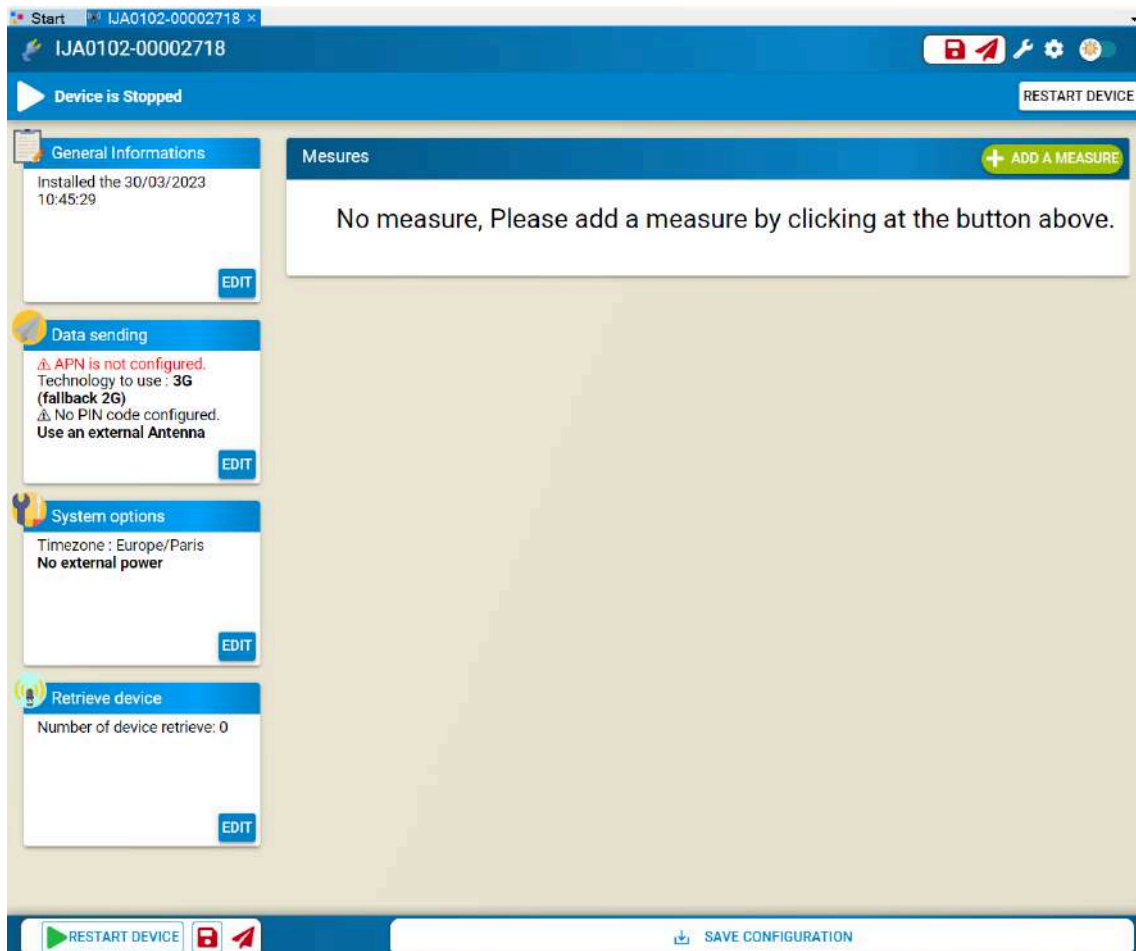

Configuration window for logger S/N: IJA0102-00002718

-> A configuration file is automatically created.

-> A folder is created in the following directory: C:\ProgramData\IjInus\Avelour_Main_7.1.2\SavedSensors\IJA0102-00002718

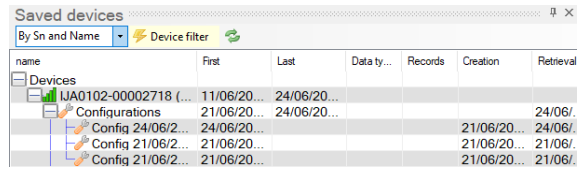

The screenshot shows a window titled "Saved devices" with a search bar and a "Device filter" button. Below is a table with columns: name, First, Last, Data ty..., Records, Creation, and Retrieval. The table content is as follows:

name	First	Last	Data ty...	Records	Creation	Retrieval
Devices						
UA0102-00002718 (...)	11/06/20...	24/06/20...				
Configurations	21/06/20...	24/06/20...				24/06/...
Config 24/06/2...	24/06/20...				21/06/20...	24/06/...
Config 21/06/2...	21/06/20...				21/06/20...	21/06/...
Config 21/06/2...	21/06/20...				21/06/20...	21/06/...

Configuration file in the saved data browser.

9.4. Protect the logger using a password

9.4.1. Activation



To activate the protection, the latest firmware version and at least version 7.3 of Avelour must be installed.

By default, password protection is not active.

To activate it:

- In the system options, click on **Activate**  and enter the following password using the required format (see [Password Format](#) paragraph).

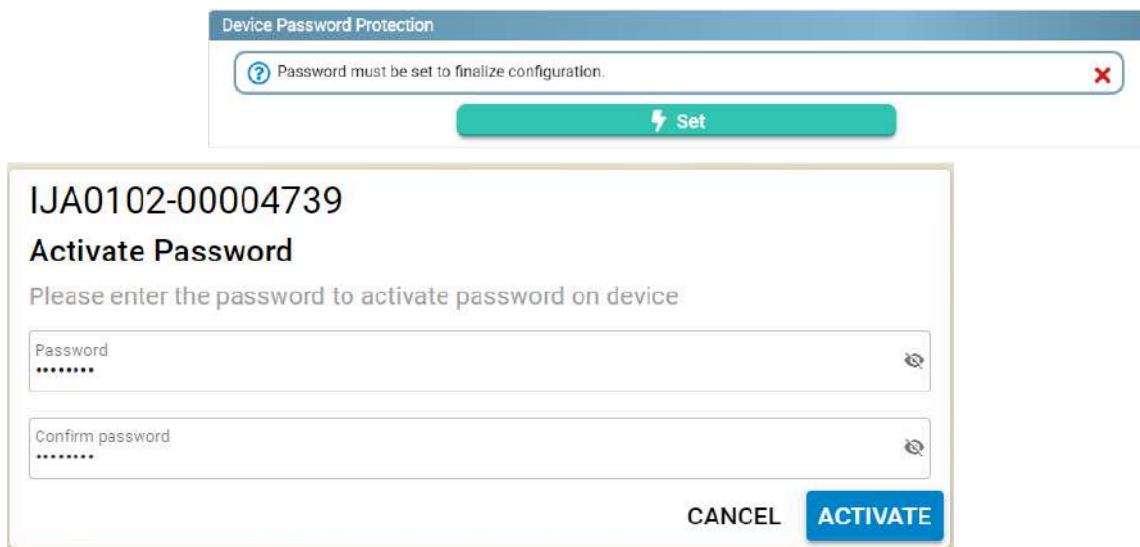

Password input and confirmation window

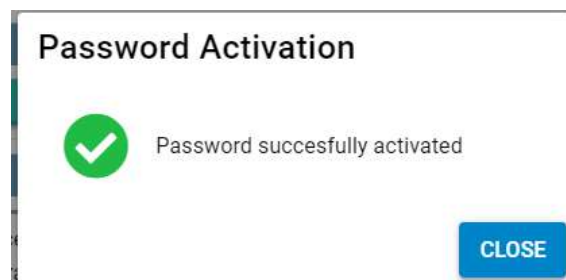

-> A temporary password is saved in Avelour for the current session and as long as Avelour is not closed, the password is not requested again.

-> After 3 failed attempts, you must redo the connection process from the start.

-> The Password is required to review the configurations that were generated while the password was activated (presence of a padlock).

IJA0102-00004708	12/05/20...
Configurations	12/05/20...
Config. 13/05/2025 16:24:...	13/05/20...
Config. 13/05/2025 16:21:...	13/05/20...
Config. 13/05/2025 14:30:...	13/05/20...
Config. 13/05/2025 14:30:...	13/05/20...
Config. 13/05/2025 08:50:...	13/05/20...
Config. 13/05/2025 08:47:...	13/05/20...
Config. 13/05/2025 08:47:...	13/05/20...
Config. 12/05/2025 17:12:...	12/05/20...

Password-locked configuration files

9.4.2. Password Format

The rules for the password format are as follows:

- Maximum length of 64 characters.
- Characters NOT allowed: **Space, accent and cedilla** .
- Minimum length: 1 character.
- No restrictions on the combination of characters.

9.4.3. Forgotten password

In case of a forgotten password:

- Manually reset the logger. (see [Manual reset](#)).



A manual reset deletes all settings and data files stored on the logger.

9.5. General configuration information

Editing the general information parameters allows you to input information concerning the identification of the logger, the measurement point, the date and any comments.

- Click on "Edit" and enter the required information if necessary.

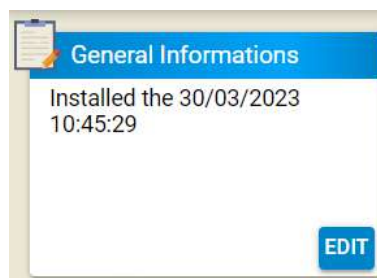

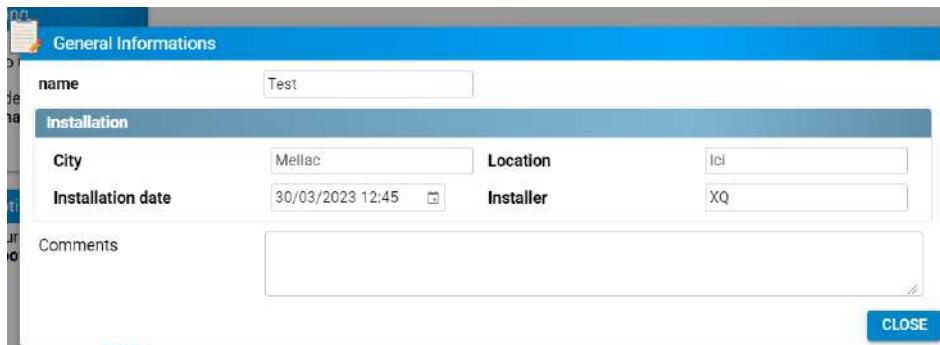

General information editing window

9.6. Configuring a measurement recording

9.6.1. Intelligent low-power Doppler measurement (Ubertone sensor)

Principle

The Ubertone sensor is a Doppler-effect velocity sensor. Placed in the opposite direction to the flow, its principle is to measure the velocities of bubbles and/or particles present in the water, assuming that they are moving at the same speed as the water. Ubertone technology measures the velocity of bubbles and/or particles in a 65° emission cone (relative to the horizontal), with a propagation angle of 10°. In less than a second, the sensor fires more than 1,000 ultrasonic beams at a frequency of 1 MHz.

The Doppler velocity sensor can be connected to an energy pack, which in turn is connected to the water level sensor, or powered directly by the internal battery. The height sensor needs to be configured, as it controls velocity measurement, height measurement, a number of calculations and data transmission.

Configuration

- Click  to add a measurement configuration and select "Intelligent low-power Doppler measurement".
- Select a measure period identical to that set for level measurement.

Ubertone Doppler

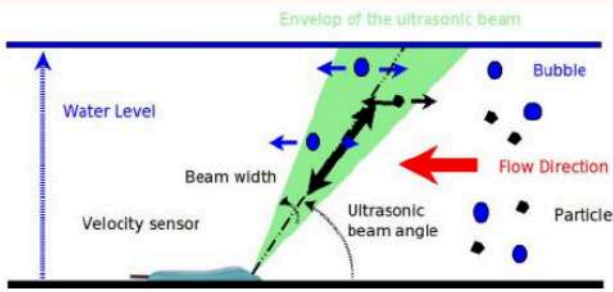
?

[Usage and parameters documentation](#)

Measure period

Record base diagnostic data Off

[Go to power configuration menu](#)

No external power

Force a measure

Diagnostic

Test measure

VIEW RESUME

Operation in default configuration

In simple mode (default setting), the doppler is configured as follows:

- Whatever the threshold of usable echo quantity (Doppler quality channel 1), the sensor will propose a velocity value.
- For each velocity measurement, a global quality code (Doppler channel 0) is calculated, ranging from 0 to 4:
 - 4: best quality.
 - 2 or 3: the average value from the sensor (Channel 1) is not representative of the actual flow velocity. This configuration is most often encountered when the water level is low: less than 5 cm, i.e. less than 2 to 3 cm above the sensor. In this case, since the average velocity (1) of the sensor is not representative, the Hydraulic indicator (noted at 3, i.e. $V_{\text{average}} / V_{\text{max}}$) cannot be used for typical values either.
 - 0: sensor does not respond.

If the mean velocity (channel 0) is greater than 200 mm/s and the ratio between the standard deviation (channel 2) and its mean velocity is less than 0.25 (i.e. less than 25% variation), then the proposed velocity (i.e. channel 0 - the one used to calculate flow in the LNU) will be the mean velocity obtained from the sensor, and the sensor's overall quality code (Doppler quality channel (0)) will be equal to 4.

If the quality code is less than 4 (in this case 3 or 2), then the velocity (proposed in channel 0) will be derived from the maximum sensor velocity (channel 3) multiplied by 0.8 (multiplying factor).

Measure check

- Click to view Ubertone sensor measurement results.

If the sensor cannot provide a reliable measurement, then Measurement quality = 1 and Velocity after processing = -9999 mm/s (default replacement value).

If the sensor does not respond, then Measurement quality=0 and Velocity= +9999 mm/s.



Typical values may differ from site to site. The two most important indicators are:

- global (4 = best, 1 = worst),
- Doppler SNR (20 = best, <10 poor).

The hydraulic indicator should only be interpreted if the global quality code is 4.

Channel	Measurement quality (0-4)	Typical values
Channel 1	EchoSnr: exploitable echo quantity - Water bubble/particle indicator (0-40 dB)	<ul style="list-style-type: none"> • 0 to 3 in air • 3 to 10 between air & water • from 10 to 40 in water (40 being strictly wastewater or multiple)
Channel 2	DopplerSnr: Doppler evaluation quality (0-20 dB)	<ul style="list-style-type: none"> • below 10: mediocre • from 10 to 16: good • from 16 to 20: excellent
Channel 3	Hydraulic indicator: ratio between average Ub Velocity and Max Ub Velocity (%)	<ul style="list-style-type: none"> • Under 70%: poor quality or special structure • between 70% and 90%: circular current
Channel 4	Flow direction: 0 or 1	<ul style="list-style-type: none"> • 1: Velocity > 0 • 0: Velocity < 0

Diagnostic

- Click  **Diagnostic** to view all the parameters measured by the Ubertone sensor.

Channel	Velocity after processing
Channel 1	Average Ub velocity
Channel 2	Standard deviation Velocity Ub
Channel 3	Max Ub velocity
Channel 4	Min Ub speed



If the collector is horizontal and at the bottom of the collector -> Pitch=Roll=90°.

These angles have no influence on the calculation, but are used to determine the position of the sensor. Their resolution to 1° also makes it impossible to measure the slope of the collector.

Measurement parameters (advanced settings)

- Click  to display the following measurement parameters.

Measurement parameters

<p>Threshold applied to the quantity of usable echo - 0.00 dB +</p> <p>coefficient applied to maximal velocity - 0.80 +</p> <p>Record temperature <input type="checkbox"/> Off</p>	<p>Replacement velocity value if measurement are impossible - -8888.00 mm/s +</p> <div style="background-color: #00a651; color: white; text-align: center; padding: 5px; margin: 10px 0;"> ⚡ Ubertone Firmware </div> <p>Record advanced diag data <input type="checkbox"/> Off</p>
---	---

Threshold applied to quantity of exploitable echo : Usable echo quantity - Water bubble/particle indicator (0-40dB).

Replacement velocity value if measurement impossible : select a value

Coefficient applied to maximum velocity

Record temperature : The sensor is fitted with a temperature probe.

Expert mode

- If expert mode is enabled, click  to display expert mode settings.

Expert mode

<p>High Threshold applied to the Doppler SNR - 14.00 dB +</p> <p>Minimum measurement value - -1000.00 mm/s +</p> <p>Quality Threshold for High Velocity - 0.25 +</p> <p>Threshold applied to Doppler SNR - 6.00 dB +</p> <p>coefficient applied to min velocity - 0.00 +</p> <p>Record advanced diagnostics <input type="checkbox"/> Off</p>	<p style="color: #e67e22;">Threshold low/high velocity for standart deviation use - 200.00 mm/s +</p> <p>Maximum measurement value - 4000.00 mm/s +</p> <p>Quality Threshold for Low Velocity - 0.00 mm/s +</p> <p>coefficient applied to average velocity - 0.00 +</p> <p>Divider of the linear combination - 1.00 +</p>
--	--

Paramétrage en mode expert

Fifo Memory (Advanced Setting)

By default, when the logger memory is full, data are deleted in chronological order of recording, from oldest to newest.

- Click  to display advanced settings.
- If Fifo memory is disabled, change the maximum number of timestamps for the main memory (used for sending data via Internet) and the auxiliary memory (used for sending data via SMS) if necessary.

Maximum records - 50000 +
SMS Maximum records - 50000 +

Configuration summary

To view the configuration summary:

- Click [SEE OVERVIEW](#) to display a summary of the configuration.

Mapping table between DataID, channel & data

DataId	Channel	Data displayed	Units	Data Description	Data files
3	7	Debug (signed integer value)	mAh	Internal battery current consumption	*_diag.bin
6	0	Voltage	V	Instantaneous internal battery voltage (Res. 0.05 V)	*_diag.bin
6	1	Voltage	V	Minimum internal battery voltage reached (Res. 0.05 V)	*_diag.bin
6	2	Voltage	V	Instantaneous external battery voltage (Res. 0.05 V)	*_extbat.bin
12	1	Measure temperature	°C	Sensor temperature measurement (Res. 0.1°C)	*_ubflowav.bin, *_di-ag-ubflowav.bin
17	0	GSM signal Power	dBm	GSM signal power	*_diag.bin
19	0	Date	-	POSIX time	Asynchronous data
24	0	Velocity	mm/s	Treated velocity	*_ubflowav.bin, *_di-ag-ubflowav.bin
24	1	Velocity	mm/s	Average raw velocity	*_ubflowav.bin, *_di-ag-ubflowav.bin
24	2	Velocity	mm/s	Standard deviation raw velocity	*_ubflowav.bin, *_di-ag-ubflowav.bin
24	3	Velocity	mm/s	Maximal raw velocity	*_ubflowav.bin, *_di-ag-ubflowav.bin
24	4	Velocity	mm/s	Minimal raw velocity	*_ubflowav.bin, *_di-ag-ubflowav.bin
25	0	Doppler quality signal	%	Sensor quality (0-4)	*_ubflowav.bin, *_di-ag-ubflowav.bin
25	1	Doppler quality signal	%	EchoSnr (0-40 dB)	*_ubflowav.bin, *_di-ag-ubflowav.bin

DataId	Channel	Data displayed	Units	Data Description	Data files
25	2	Doppler quality signal	%	DopplerSnr (0-20 dB)	*_ubflowav.bin, *_di-ag-ubflowav.bin
25	3	Doppler quality signal	%	Hydraulic indicator (%)	*_ubflowav.bin, *_di-ag-ubflowav.bin
25	4	Doppler quality signal	%	Flow direction (0 or 1)	*_ubflowav.bin, *_di-ag-ubflowav.bin
44	0	Angle	°	Roll angle (Res. 0.1°)	*_di-ag-ubflowav.bin
44	1	Angle	°	Pitch angle (Res. 0.1°)	*_di-ag-ubflowav.bin

9.6.2. Water height measurement: Low-profile Doppler (IAVL sensor)

Principle

The IAVL sensor measures the water level using a built-in piezoresistive sensor.

Configuration



Prerequisites: In Avelour, the Wiji connection to the logger must be established, see [Connecting to a logger](#).

- Click  to add a measurement configuration and select "IAVL sensor: Low Profile Doppler measurement".

Piezoresistive water level

IAVL sensor : Low Profil Doppler measurement
🗑️ ⚙️

Measurement period 15 mn ▾

[Go to power configuration menu](#)

No external power

Piezoresistive water level

Water level offset mm ⊖ ⊕

Water level record On

Adjustment value 0mm  **Calibrate**

(Recorded value = measurement + offset + adjustment value)

Doppler velocity

Velocity measurement only above a level threshold On

Correct the velocity in case of a measurement error ▾ By the last valid value

Information : velocity and diagnostics are null in case of a measurement error

Consider the negative velocities as null Off

Level threshold mm ⊖ ⊕

Doppler diagnostics record Off

Information : 3 available diagnostics : the particle density, the amount of useful signal, and the flow direction homogeneity (unit : %)

Flowrate

Height/surface table (empty)  **Fill table**

Volume (provided that you have entered the height/surface table)

Periodic volume accumulation Inactive Hourly ▾

Off Sampler enslaving

Infinite volume accumulation Off

Off Change measure period on threshold
 Off Define a threshold

 **Test measure**
VIEW RESUME

- Enter an **offset** on the measured height if the sensor is not placed at the bottom of the structure where we wish to measure the height
- Click  calibration if necessary to adjust the value measured by the IAVL sensor with the actual height value H.

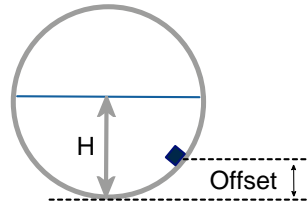

Doppler velocity

Doppler velocity

Velocity measurement only above a level threshold **On** Level threshold mm

Correct the velocity in case of a measurement error

Information : velocity and diagnostics are null in case of a measurement error

Consider the negative velocities as null **Off** Doppler diagnostics record **Off**

Information : 3 available diagnostics : the particle density, the amount of useful signal, and the flow direction homogeneity (unit : %)

Velocity measurement only above a level threshold : Activated by default. **Level threshold** : Threshold above which velocity measurement is active.

Correct the velocity in case of a measurement error : By the last valid value or By a specific value or No.
If By a specific value is selected: Define a **Corrective velocity**.



Velocity and diagnostics are null in case of a measurement error.

Consider the negative velocities as null : Activate if necessary.

Doppler diagnostics record : Activate if necessary.



3 quality indicators available: particle density, amount of useful signal, and flow direction homogeneity (unit: %)

Useful signal amplitude

This is a direct indication of the amount of amplification applied to the unprocessed return signal received.

- 0% means that the amplifier has been set to "10", i.e. at its maximum.
- 100% means no amplification was required.

Typically, the rate is between 40% and 75%, but a lower or even slightly higher value may simply indicate the conditions under which the device is operating. With this value, the aim is to observe a regular daily or event trend that remains consistent. If you start to observe a deterioration in this value, it probably indicates that silt, sediment or something else is beginning to accumulate on or in front of the sensor, affecting the measurement.

Particle density

Velocity measurement is based on the Doppler shift of the signal reflected by suspended particles and entrained air (bubbles) in the flow. However, reflections from other objects are also picked up, such as surface turbulence, eddy currents, stationary debris, a hanging rag upstream waving in the flow, etc... These reflections are not representative of velocity, so if they were used in processing where the unit determines average velocity, the result would be wrong. There is therefore an algorithm that eliminates these non-velocity-related components, before moving on to the weighted average process to determine the mean velocity.

As with the useful signal amplitude, the trend should be checked for consistency rather than a specific threshold. As a general rule, the rate will range from 40% to 75%, but higher or lower rates are not a bad thing. There is a lower limit: any result below 22% will result in a velocity error, as it is considered insufficient to determine a velocity.

In short, this indicator provides information on the amount of information remaining once the non-speed-related components have been eliminated from the return signal. For example, a value of 54% means that 46% of the return signal was considered to be unrelated to velocity.

Homogeneity of flow direction

This quality indicator gives the signal strength in the indicated direction of flow. The value should be equal to or close to 100% most of the time. It is possible to have a value of 100% indicating forward speed, or 100% indicating reverse speed. In all events, the desired result is 100%, or a constant HIGH number.

Bidirectional components are always present in the return signal. Even flow hitting the front end of the sensor creates a vortex, resulting in negative velocity components due to the fact that the flow has to move over or around the sensor. Other flow characteristics may also indicate the opposite direction. A highly turbulent application will have many bidirectional components

- 100% means that, whatever the direction of the reported flow, the information received in that direction is 100 times greater than in the opposite direction.
- 50% means 50 times more.
- 0% means it has received a signal indicating both forward and reverse in roughly equal proportions. 0% always means that the velocity measurement has failed and is erroneous.

Flow rate

- To calculate the flow rate, please refer to the excel form available via the link on Avelour.
- Fill in the height/surface table by clicking on .

Flowrate

Height/surface table (empty)

 Fill table

Change measure period on threshold

On Change measure period on threshold

Period on threshold	<input type="text" value="5 mn"/>		
Value Type	<input type="text" value="Height"/>	Direction	<input type="text" value="Go above a level"/>
value	<input type="text" value="10.000"/> mm	Hysteresis	<input type="text" value="0.000"/> mm

Define a level

On
Define a threshold

Value type	<input type="text" value="Height"/>	Direction	<input type="text" value="Go above a level"/>
value	<input style="width: 100%;" type="text" value="10.000 mm"/>	Hysteresis	<input style="width: 100%;" type="text" value="0.000 mm"/>
Delay to validate activation	<input type="radio"/> Inactive <input type="text" value="0 h"/> <input type="text" value="0 min"/> <input type="text" value="0 sec"/>	Delay to validate deactivation	<input type="radio"/> Inactive <input type="text" value="0 h"/> <input type="text" value="0 min"/> <input type="text" value="0 sec"/>
Record Threshold	<input checked="" type="checkbox"/> On	Anticipate data sending	<input type="text" value="No"/>

Direction: Defines whether the measured level threshold passes **go above a level** or **on rise of at least**.

Value : Sets the height threshold.

Hysteresis : Value to be subtracted from or added to the threshold.

Delay to validate activation : Time at which threshold is reached.

Delay to validate deactivation : Time after which the threshold is no longer reached.

Anticipate data sending : Data transmission can be forced to activation, deactivation or both.

Repeat sending : If data transmission on activation is selected, enables you to modify the data transmission period.



If anticipate data sending is activated, when the threshold is reached, an alert SMS is sent to an operator if this option is configured (see [Sending an alert SMS](#)).

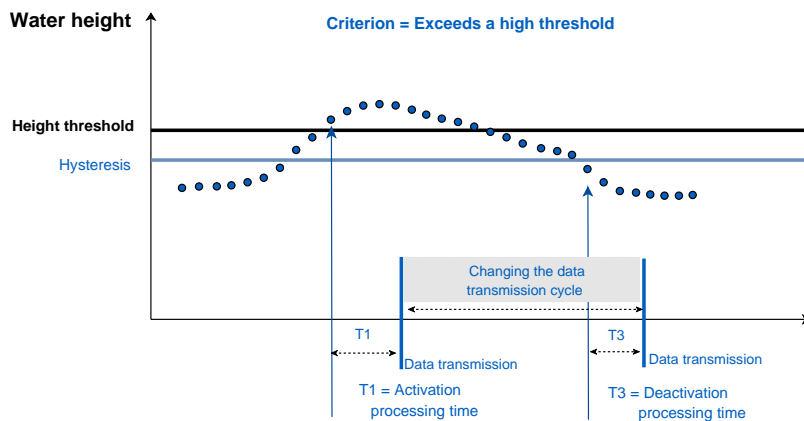

Set a second threshold

On
Define a second threshold

Value type Height ▾

value - 10.000 mm +

Direction Go above a level ▾

Hysteresis - 0.000 mm +

Delay to validate activation Active ● 0 h 0 min 0 sec

Delay to validate deactivation Inactive ● 0 h 0 min 0 sec

Record Threshold On ●

Anticipate data sending No ▾

Direction: Defines whether the measured level passes **above a high level** or **below a low level**.

Value : Height threshold.

Hysteresis : Value to be subtracted from/added to threshold.

Delay to validate activation : Time at which threshold is reached.

Delay to validate deactivation : Time after which the threshold is no longer reached.

Anticipate data sending : Data transmission can be forced to activation, deactivation or both.

Repeat sending : If a data send on activation is selected, the data can be returned after a defined period.



If anticipate data sending is activated, when the threshold is reached, an alert SMS is sent to an operator if this option is configured (see [Sending an alert SMS](#)).

Configuration summary

To view the configuration summary:

- Click SEE OVERVIEW to display a summary of the configuration.

IAVL sensor : Low Profil Doppler measurement
✕

Doppler velocity + piezoresistive water level + temperature record every **15 mins**
 Velocity measurement **only above** a water level of **25 mm Threshold(s) defined**
 Recording will last for about 10 days 10 hrs / Send around 2.9 SMS each day

⚡ Test measure
EDIT

Mapping table between DataID, channel & data

DataId	Channel	Data displayed	Units	Data Description	Data files
3	7	Debug (Entier signé)	mAh	Internal battery current consumption	*_diag.bin
6	0	Voltage	V	Instantaneous internal battery voltage (Res. 0.05 V)	*_diag.bin
6	1	Voltage	V	Minimum internal battery voltage reached (Res. 0.05 V)	*_diag.bin
6	2	Voltage	V	Instantaneous external battery voltage (Res. 0.05 V)	*_extbat.bin, *_ext-volt.bin

DataId	Channel	Data displayed	Units	Data Description	Data files
12	0	Measure temperature	°C	Sensor temperature measurement (Res. 0.1°C)	*_iavl.bin
15	0	Material height	mm	Piezoresistive water height	*_iavl.bin
17	0	GSM signal Power	dBm	GSM signal power	*_diag.bin
19	0	Date	-	POSIX time	Asynchronous data
20/0	0-7	Overflow/State	-	First threshold event	*_iavlt1.bin
20/0	0-7	Overflow/State	-	Second threshold event	*_iavlt2.bin
24	0	Velocity	mm/s	Doppler velocity	*_iavl.bin
25	0	Doppler quality signal	%	Useful signal quantity	*_iavl.bin
25	1	Doppler quality signal	%	Particle density	*_iavl.bin
25	2	Doppler quality signal	%	Homogeneity of flow direction	*_iavl.bin
34	0	Flow rate	m ³ /s	Water flow rate	*_iavl.bin
39	0-15	Volume	m ³	Infinite volume accumulation	*_iavl.bin
39	0-15	Volume	m ³	Periodic volume accumulation	*_voliavl.bin

9.6.3. Doppler velocity measurement (Nivus sensor)

Principle



The Nivus wedge and cylindrical sensors measure velocity by the Doppler effect. Placed opposite to the direction of flow, the principle is to measure the speeds of bubbles and/or particles present in water. The hypothesis being that they move at the same speed as water.

Configuration



Prerequisites: In Avelour, the Wiji connection to the logger must be established, see [Connecting to a logger](#).

- Click  to add a measurement configuration and select "Nivus sensor: Doppler speed measurement".

Nivus sensor : Doppler velocity measure  

Measure period 15 mn

[Go to power configuration menu](#)

No external power

Doppler parameters

Transmit frequency 1000 kHz (Wedge sensor)
 Damping (s) - 5.00 s +

Temperature record off
 Doppler measure quality record off

Piezoresistive height record off

Caution! Ensure you that the Doppler sensor is equipped with a pressure cell

 Test measure
VIEW RESUME

Doppler settings

Transmit frequency : Select the sensor type *wedge 1000 kHz* or *cylindrical 750 kHz*.

Damping period (s): Sliding average over time (minimum and by default 5 seconds).

- Activate  recording of the following data as necessary:
 - temperature
 - Doppler measurement quality
 - piezoresistive height (1000 kHz wedge sensor)



Verify that the Doppler sensor is properly equipped with a pressure sensor.

Configuration summary

To view the configuration summary:

- Click [SEE OVERVIEW](#) to display a summary of the configuration.

Nivus sensor : Doppler velocity measure 

Velocity + temperature measure every **15 mins**
Recording will last for about 1 yr 5 mths / Send around 1.9 SMS each day

 **Test measure** **EDIT**

9.6.4. Doppler velocity and overflow measurement (Nivus sensor)

Principle

The Nivus wedge and cylindrical sensors measure velocity by the Doppler effect. Placed in the opposite direction to the flow, its principle is to measure the velocities of bubbles and/or particles present in the water, assuming that they are moving at the same speed as the water.



The NIVUS sensor makes it possible to measure the water level using a built-in piezoresistive sensor.

Configuration



Prerequisites: In Avelour, the Wiji connection to the logger must be established, see [Connecting to a logger](#).

- Click  to add a measurement configuration and select "Nivus sensor: Doppler velocity measure and overflow (optional flow)".

Nivus sensor : Doppler velocity measure and overflow (optional flow)
 

Measure period 15 mn

[Go to power configuration menu](#)
No external power

Doppler parameters

Transmit frequency 1000 kHz (Wedge sensor) Damping (s) 5.00 s

Temperature record off Doppler measure quality record off

off Options Height / Flow for Doppler sensors with integrated piezoresistive height measure

Overflow configuration

Overflow detector device Contact input/Counter 1-100Hz (13) Overflow detector device Wired as normally open (NO)

Measure period when no overflow inactive 1 h

Record overflows off Repeat data sending when in overflow off

Set the minimum delay between 2 data sending in the 'Data sending' tab

VIEW RESUME

Doppler parameters

Transmit frequency : Select sensor type *wedge 1000 kHz* or *cylindrical 750 kHz*.

Damping period(s): Sliding average over time (minimum 5 seconds)

Temperature record  : The sensor is fitted with a temperature probe.

Doppler measure quality record 

Height / Flow options for Doppler sensor with integrated piezoresistive height measure

On Options Height / Flow for Doppler sensors with integrated piezoresistive height measure

Piezoresistive height record Off

Adjustment value Calibrate

(Recorded value = measurement + offset + adjustment value)

Height correction Offset mm Fill table

Flow conversion with height/surface table (empty)

- Activate **Piezoresistive height record** if necessary.
- Enter an offset on the measured height if the sensor is not placed at the bottom of the structure where we wish to measure the height.

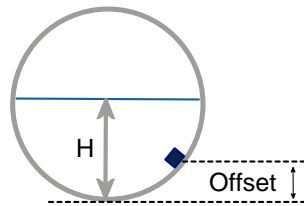

- Click ⚡ **Calibrate** if necessary to adjust the value measured by the IAVL sensor to the actual height value.
- Fill in the height/surface table by clicking on 📄.

Overflow configuration

Overflow sensor peripheral device: see [M12 8-pin connector](#)

- Activate a **Velocity measurement period excluding overflow** to change the measure period.
- Activate **overflow recording** to record overflow states (0 or 1).
- Activate the **Periodic overflow data transmission** and in this case enter the minimum time between two data transmissions (see [Configure an alarm](#)).

Configuration summary

To view the configuration summary:

- Click SEE OVERVIEW to display a summary of the configuration.

Nivus sensor : Doppler velocity measure and overflow (optional flow) 🗑️

Velocity measurement every **15 mins on overflow** / never out of overflow
Inactive recording of overflows, **normally open** wiring
Recording will last for about 1 yr 5 mths / Send around 1 SMS each day

EDIT

9.6.5. Flow measurement: Doppler speed + built-in piezoresistive height (Nivus sensor)

Principle

The NIVUS sensor makes it possible to measure the water level using a built-in piezoresistive sensor.

Configuration



Prerequisites: In Avelour, the Wiji connection to the logger must be established, see [Connecting to a logger](#).

- Click  to add a measurement configuration and select "Nivus sensor: Doppler speed + integrated piezoresistive height -> Flow".

Combined Doppler speed/piezoresistive height sensor

Doppler velocity sensor with integrated piezoresistive height

Doppler velocity record <input type="checkbox"/> Off	Temperature record <input type="checkbox"/> Off
Doppler measure quality record <input type="checkbox"/> Off	
Height correction Offset <input type="text" value="0"/> mm <input style="border: none; padding: 0 5px;" type="button" value="+"/> <input style="border: none; padding: 0 5px;" type="button" value="-"/>	Adjustment value <input type="text" value="0mm"/> <input style="background-color: #00a651; color: white; padding: 5px 10px; border: none; border-radius: 5px; margin-left: 20px;" type="button" value="Calibrate"/>

(Recorded value = measurement + offset + adjustment value)

Off Change measure period on height threshold

- Enter an **offset** on the measured height if the sensor is not placed at the bottom of the structure where we wish to measure the height **H**.

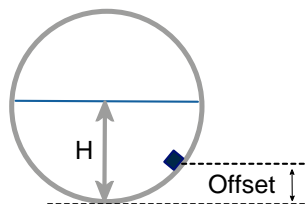

- Click  Calibrate if necessary to adjust the measured value with the actual height value.

Modifying the frequency of measurements on a measurement threshold

- Activate  as needed **change measure period on height threshold** to view configuration settings.

Modification of measures to: New measurement frequency.

Direction: Defines whether the measured level exceeds a **high threshold** or a **low threshold**.

Height : Threshold to be reached to activate modification. **Hysteresis :** Value to be subtracted (high threshold) or added (low threshold) to the level at which the measurement frequency returns to its initial value.

Minimum time before deceleration : Hold time for the new measurement frequency before returning to its initial value.

Example below: The measurement frequency increases from 15 minutes to 2 minutes if the water level exceeds 500 mm. When the water level falls below the threshold of 400 mm, it returns to 15 minutes.

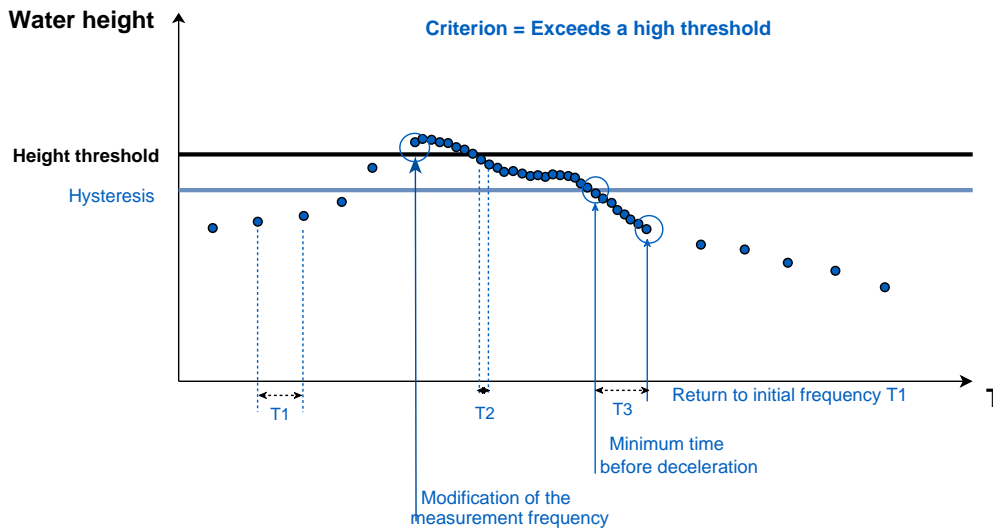

Doppler settings

Transmit frequency : Choice of the type of sensor, wedge 1000 kHz or cylindrical 750 kHz.

Damping period (s): Sliding average over time (minimum 5 seconds).

Doppler parameters	
Transmit frequency	1000 kHz (Wedge sensor) - Damping (s) <input type="text" value="5.00"/> s <input type="button" value="+"/>

Debit

- To calculate the flow rate, refer to the excel form available via the link on Avelour.
- Fill in the height/surface table by clicking on .

Flowrate	
Height/surface table (empty)	<input type="button" value="Fill table"/>

Fifo Memory (Advanced Setting)

By default, when the logger memory is full, data are deleted in chronological order of recording, from oldest to newest.

- Click  to display advanced settings.
- If Fifo memory is disabled, change the maximum number of timestamps for the main memory (used for sending data via Internet) and the auxiliary memory (used for sending data via SMS) if necessary.

Maximum records	<input type="text" value="50000"/>	SMS Maximum records	<input type="text" value="50000"/>
-----------------	------------------------------------	---------------------	------------------------------------

Configuration summary

To view the configuration summary:

- Click [SEE OVERVIEW](#) to display a summary of the configuration.

Nivus sensor : Doppler velocity + integrated piezoresistive height -> Flow 

Water height measure every **15 mins**
Changed measurement period 5 mins, when the measure Go above a level at **100mm**, Hysteresis : 100mm
Recording will last for about 1 yr 5 mths (5 mths with changed period) / Send around 1 SMS each day (2.9 with changed period)

 **Test measure** **EDIT**

9.6.6. Conductivity measurement (B&C sensor)

Principle

The B&C sensor is used to measure conductivity by induction. An electric current passes through an emission coil to induce a magnetic field in the liquid. A current is then applied to the ions present in the liquid. This current is measured by a receiving coil and makes it possible to define the conductivity of the liquid.

Configuration



Prerequisites: In Avelour, the Wiji connection to the logger must be established, see [Connecting to a logger](#).

- Click  to add a measurement configuration and select “B&C sensor”.

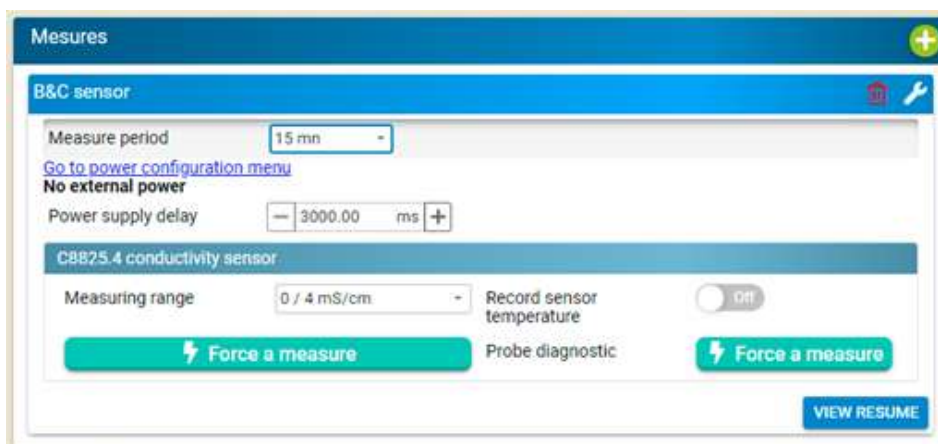

Measurement parameters with a B&C sensor

Measure period

- From the list, select a length of time between each measurement. In the example above, a measurement will be taken every 15 minutes.

Power supply

It is possible to power an external sensor directly from the internal battery of the logger. In this case, no specific settings are required.

It is also possible to use an external battery or AC power supply (7-30 V).

- If an external power supply (battery or mains) is connected to the logger, refer to paragraph [Using a power pack](#)

For the B&C sensor, the possible voltage ranges from a minimum of 9 V to a maximum of 36 V.

By default, the power supply delay is set at 3000 ms (3 seconds), which corresponds to the time required for the B&C conductivity sensor.

Measuring range



Two different ranges are available: 0 — 4 mS/cm or 0 — 200 mS/cm

- Select the range according to the expected conductivity values.

Temperature

- Activate  recording of the temperature measured by the sensor if necessary.

View measured values

- Click the button  on the left to display the measured conductivity and temperature values.
- Click the button  on the right to show the sensor configuration.

Fifo Memory (Advanced Setting)

By default, when the logger memory is full, data are deleted in chronological order of recording, from oldest to newest.

- Click  to display advanced settings.
- If Fifo memory is disabled, change the maximum number of timestamps for the main memory (used for sending data via Internet) and the auxiliary memory (used for sending data via SMS) if necessary.

Maximum records
SMS Maximum records

Configuration summary

- Click [SEE OVERVIEW](#) to display a summary of the configuration.

Depending on the parameters selected, the recording time remaining before the memory is full is also given, as well as an average of the number of text messages sent per day.

B&C sensor

Measurement every 15 mins

Recording of conductivity / Range : 0 / 4 mS/cm

Recording will last for about 1 yr 5 mths / Send around 1 SMS each day

9.6.7. Physical-chemical measurement

Principle

C4E physical-chemical sensor:

The electrode uses 4-electrode technology: an alternating current of constant voltage is established between a pair of primary graphite electrodes. Secondary platinum electrodes make it possible to regulate the voltage imposed on the primary electrodes, to take account of fouling. The voltage measured between the primary electrodes depends on the resistance of the medium and therefore of its conductivity.

CTZN physical-chemical sensor

A toroidal coil is excited at a fixed frequency and the response is retrieved on a second coil aligned on the first. The coupling depends on conductivity and occurs through the intermediary of the conductive solution.

NTU physical-chemical sensor

The measurement principle is based on nephelometry: a diode emits an Infra-Red light (880nm) and a receiving diode placed at 90° measures the scattered radiation (normalized measurement). The sensor can be calibrated using a Formazine standard.

OPTOD physical-chemical sensor

The OPTOD® dissolved oxygen sensor uses optical luminescence measurement technology approved by ASTM International Method D888-05. This innovative method ensures reliable, accurate measurements without calibration. The OPTOD sensor enables an immediate return on investment as it requires no consumables or maintenance. Only the DoDisk needs to be changed every two years. As it does not consume oxygen, the OPTOD sensor is suitable for all environments, including those with very low water circulation.

PHEHT physical-chemical sensor

The sensor integrates an Ag/AgCl type reference electrode, used for pH and Redox measurements, with a plasticized electrolyte saturated with KCl "PLASTOGEL"®.

The "PLASTOGEL"® electrolyte communicates directly with the external environment without the interposition of capillaries or pores. There is therefore no risk of blocking or de-priming the reference. The measurement electrodes take the form of a special glass bulb sensitive to pH and soldered to the end of a crystal tube for pH and in the form of a platinum tip for redox.

Configuration



Prerequisites: In Avelour, the Wiji connection to the logger must be established, see [Connecting to a logger](#).

The sensor is connected to the logger.

- Click  to add a measurement configuration and select "Physicochemical measurement (conductivity, turbidity, pH, dissolved oxygen)".
- Select a period between each measurement from the list. In the example above, a measurement will be taken every 15 minutes.

Physicochemical measure (conductivity, turbidity, pH, dissolved oxygen)
🗑️ 🛠️

Measure period 15 mn ▾

[Go to power configuration menu](#)

No external power

Power supply delay - 800.00 ms +

Off C4E conductivity sensor

Off CTZ induction conductivity sensor

Off NTU turbidity sensor

Off PHEHT Ph and Redox sensor

Off OPTOD optical dissolved oxygen sensor

VIEW RESUME

Power supply

It is possible to power an external sensor directly from the internal battery of the logger. In this case, no specific settings are required.

It is also possible to use an external battery or AC power supply (7-30 V).

- If an external power supply (battery or mains) is connected to the logger, refer to paragraph [Using a power pack](#)

By default, the power supply delay is set to 800 ms.

C4E conductivity sensor ●

Data to record : Conductivity or salinity or Conductivity + salinity.

Measurement range : Corresponds to the measurement range of the sensor according to the expected levels.

- Click the  button to start a test measurement and display the result.

Define a threshold

- See [the section called "Define a threshold"](#).

Change the measurement period (advanced setting)

- Click  to display the measurement period parameter (4000 ms by default).

Change Modbus ID

- Click  to view and edit the **Modbus ID**.

CTZ induction conductivity sensor ●

Data to record : Salinity (g/kg), Conductivity (μS/cm), Conductivity + Salinity (μS/cm)

Measurement range : Corresponds to the measurement range of the sensor according to the expected levels.

- Click the  button to start a test measurement and display the result.

Define a threshold

- See [the section called “Define a threshold”](#).

Change the measurement period (advanced setting)

- Click  to show the setting for **measurement period** (4000 ms by default).

Change Modbus ID

- Click  to view and edit the **Modbus ID**.

NTU turbidity sensor

Data to record : FNU Turbidity (FNU), Turbidity (FNU + TU), or Turbidity (TU) (mg/L)

Measurement range : Corresponds to the measurement range of the sensor according to the expected levels.

- Click the  button to start a test measurement and display the result.

Define a threshold

- See [the section called “Define a threshold”](#).

Change the measurement period (advanced setting)

- Click  to display the measurement period parameter (4000 ms by default).

Change Modbus ID

- Click  to view and edit the **Modbus ID**.

PHEHT Ph and Redox sensor

Data to record : pH, Redox (mV) or pH + Redox

Measurement range : Corresponds to the measurement range of the sensor according to the expected levels.

- Click the  button to start a test measurement and display the result.

Define a threshold

- See [the section called “Define a threshold”](#).

Change Modbus ID

- Click  to view and edit the **Modbus ID**.

OPTOD optical dissolved oxygen sensor

Data to record : *Oxygen saturation* (%Sat), *Dissolved oxygen* (mg/L) or *Dissolved oxygen + saturation*.

Measurement range : Corresponds to the measurement range of the sensor according to the expected levels.

- Click the  button to start a test measurement and display the result.

Define a threshold

- See [the section called “Define a threshold”](#).

Check correct sensor operation

- Click  to view the measured values.

-> The connection to the device is activated and a new window displays the measured values.

Change Modbus ID

- Click  to view and edit the **Modbus ID**.

Define a threshold

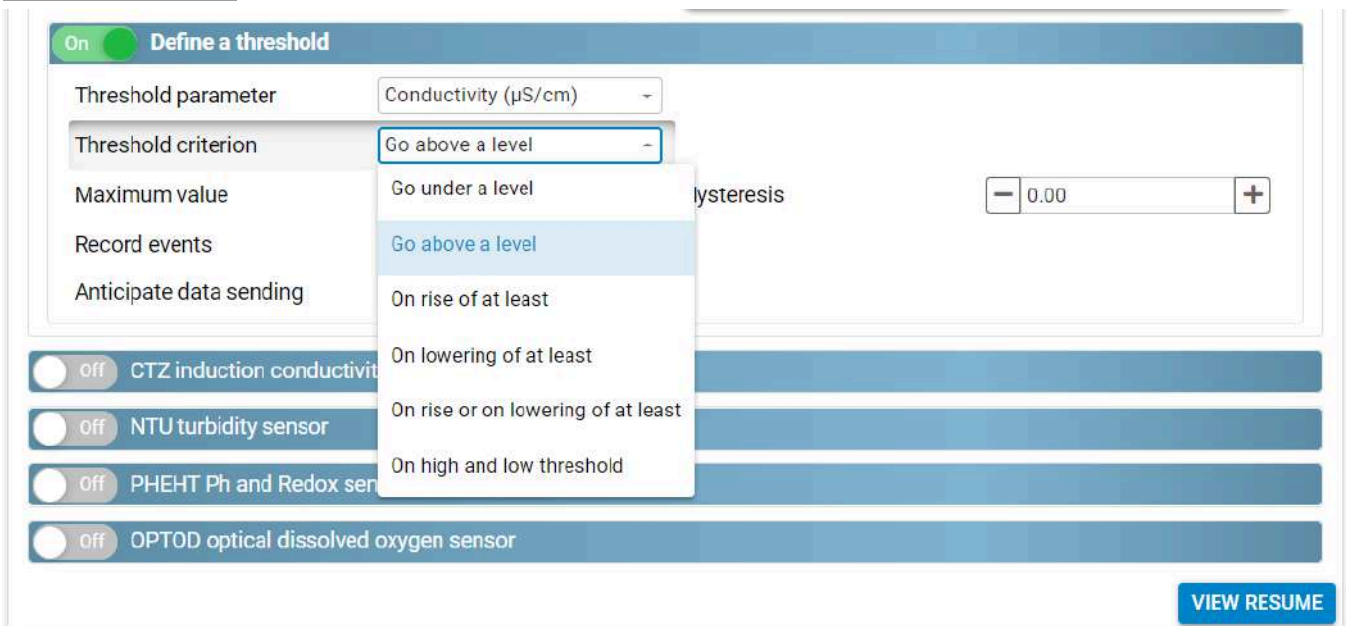

Threshold parameter : Measurement parameter to select according to the type of sensor.

Threshold criterion : Criterion defining the type of crossing:

- Go below a level: measured level passes below the configured threshold.
- Go above a high level: the measured level exceeds the configured threshold.
- On rise of at least: the value between 2 measurements exceeds the configured threshold.
- On high and low threshold: measured level exceeds the high threshold or drops below the low threshold.

Hysteresis : Value to be subtracted/added to the threshold for which its state is deactivated. **Record events** : Threshold crossing state = 0 or 1.

Anticipate data sending : Data transmission may be forced upon activation, deactivation or both. **Repeat sending** : If data transmission on activation is selected, enables you to modify the data transmission period.



If anticipate data sending is activated, an alert SMS is sent to an operator when the threshold is reached, if this option is configured (see [Sending an alert SMS](#)).

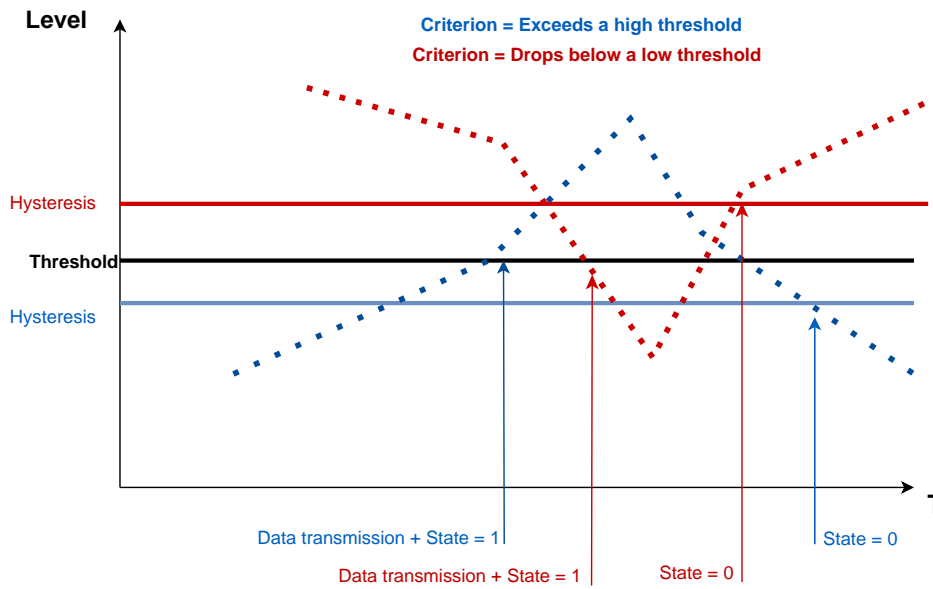
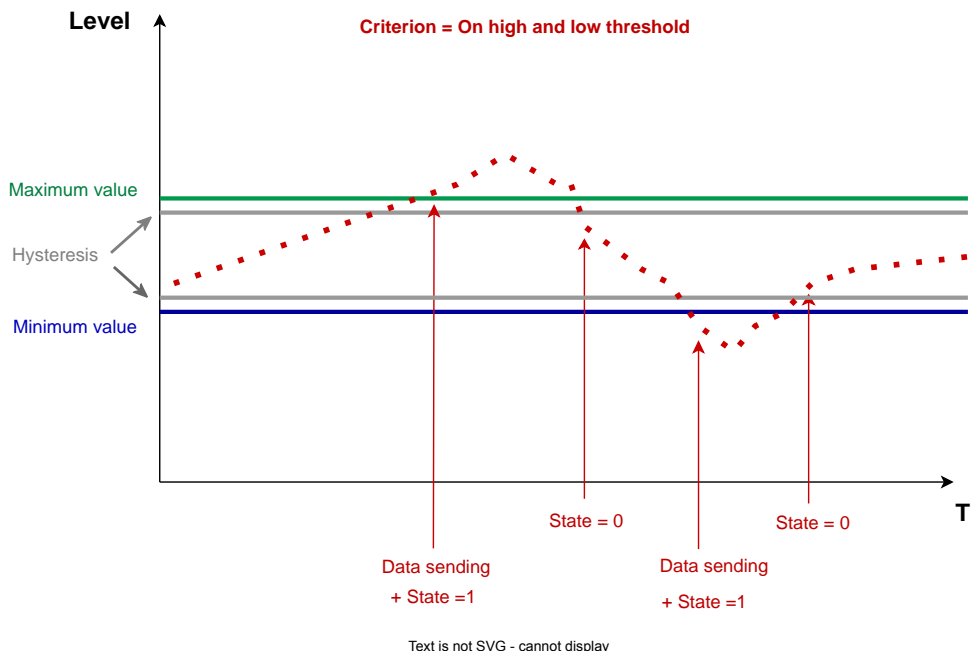

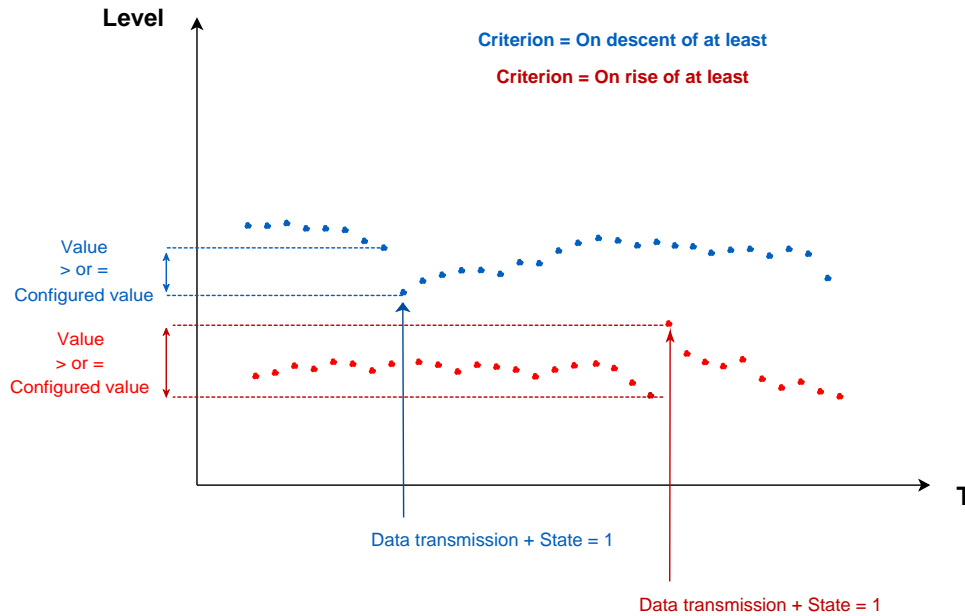

Fifo Memory (Advanced Setting)

By default, when the logger memory is full, data are deleted in chronological order of recording, from oldest to newest.

- Click to display advanced settings.
- If Fifo memory is disabled, change the maximum number of timestamps for the main memory (used for sending data via Internet) and the auxiliary memory (used for sending data via SMS) if necessary.

Maximum records SMS Maximum records

Configuration summary

To view the configuration summary:

- Click [SEE OVERVIEW](#) to display a summary of the configuration.

Physicochemical measure (conductivity, turbidity, pH, dissolved oxygen)

Physicochemical measurement every **15 mins**

Sensor **C4E** : Recording of **Conductivity + Salinity** / Range : **Automatic**

Conductivity (µS/cm) threshold according to the criterion : **Go above a level 0**, with **recording of events**, with **anticipated data sending**

Recording will last for about 10 days 10 hrs / Send around 1.9 SMS each day

[EDIT](#)

Mapping table between DataID, channel & data

DataId	Channel	Data displayed	Units	Data Description	Data files
0	0	State	-	Threshold event for conductivity C4E sensor	*_eventC4E.bin

DataId	Channel	Data displayed	Units	Data Description	Data files
0	1	State	-	Threshold event for conductivity CTZ sensor	*_eventCTZ.bin
0	2	State	-	Threshold event for turbidity NTU sensor	*_eventNTU.bin
0	3	State	-	Threshold event for pH and Redox PHEHT sensor	*_eventPHEHT.bin
0	4	State	-	Threshold event for oxygen OPTOD sensor	*_eventOPTOD.bin
3	7	Debug (signed integer value)	mAh	Internal battery current consumption	*_diag.bin
6	0	Voltage	V	Instantaneous internal battery voltage (Res. 0.05 V)	*_diag.bin
6	1	Voltage	V	Minimum internal battery voltage reached (Res. 0.05 V)	*_diag.bin
6	2	Voltage	V	Instantaneous external battery voltage (Res. 0.05 V)	*_extvolt.bin, *_extbat.bin
12	0	Measure temperature	°C	C4E conductivity sensor temperature measurement (Res. 0.1°C)	*_ponsel.bin
12	1	Measure temperature	°C	CTZ conductivity sensor temperature measurement (Res. 0.1°C)	*_ponsel.bin
12	2	Measure temperature	°C	NTU turbidity sensor FNU temperature measurement (Res. 0.1 °C)	*_ponsel.bin
12	3	Measure temperature	°C	PHEHT pH and Redox sensor temperature measurement (Res. 0.1 °C)	*_ponsel.bin
12	4	Measure temperature	°C	OPTOD oxygen sensor temperature measurement (Res. 0.1 °C)	*_ponsel.bin
17	0	GSM signal Power	dBm	GSM signal power	*_diag.bin
19	0	Date	-	POSIX time	Asynchronous data
26	0	Conductivity	µS/cm	C4E conductivity sensor conductivity measurement	*_ponsel.bin
26	1	Conductivity	µS/cm	CTZ conductivity sensor conductivity measurement	*_ponsel.bin
27	0	Salinity	g/kg	C4E conductivity sensor salinity measurement	*_ponsel.bin
27	1	Salinity	g/kg	CTZ conductivity sensor salinity measurement	*_ponsel.bin
28	4	Oxygen saturation	%	OPTOD oxygen sensor oxygen saturation measurement	*_ponsel.bin
29	4	Dissolved oxygen	mg/l	OPTOD oxygen sensor dissolved oxygen measurement	*_ponsel.bin
30	3	pH	-	PHEHT pH and Redox sensor pH measurement	*_ponsel.bin

DataId	Channel	Data displayed	Units	Data Description	Data files
31	3	Redox	mV	PHEHT pH and Redox sensor Redox measurement	*_ponsel.bin
32	2	FNU turbidity	FNU	NTU turbidity sensor FNU turbidity measurement	*_ponsel.bin
33	2	TU turbidity	mg/l	NTU turbidity sensor TU turbidity measurement	*_ponsel.bin

9.6.8. Measurement using an ISCO signature flow meter

Principle



The Signature flow meter is designed for open channel flow monitoring applications, using any combination of sampling and measurement technologies for flow rates and other parameters, and as required by the monitoring site.

Configuration



Prerequisites: In Avelour, the Wiji connection to the logger must be established, see [Connecting to a logger](#).

- Click  to add a measurement configuration and select "ISCO Signature flow meter".

Signature Flow Meter ISCO  

Datalogging period 15 mn

Information : For each data, the recording channels respect the assigned order when configuring the Signature

Datalogging

? Registers table
[More informations here](#)
X

Level(s)	<input type="checkbox"/> Off
Temperature(s)	<input type="checkbox"/> Off
Velocity(ies)	<input type="checkbox"/> Off
Volume(s)	<input type="checkbox"/> Off
Flowrate(s)	<input type="checkbox"/> Off
pH(s)	<input type="checkbox"/> Off
Conductivity(ies)	<input type="checkbox"/> Off

Modbus configuration

Signature Flow Meter ID	- 2 +	Protocol Type	RTU
Baud	9600	Data bits	8
Parity	Aucun	Stop bits	1

VIEW RESUME

Datalogging period

- From the list, select a length of time between each measurement. In the example above, a measurement will be taken every 15 minutes.



Information: For each data element, the recording channels respect the order assigned during configuration of the Signature flow meter

Data to record

It is possible to view a document by clicking on the link " More information here ". For each data element measured by an Ijinus logger, this document named "Modbus Tables" describes the address, the offset, the size and the encoding (integer, inverted integer, etc.).

Depending on the type of application chosen in the drop-down menu shown below, the table applied (and therefore the data encoding) will not be the same. You must therefore use the correct register table to be able to send the desired measurements to the PLC.

- Activate the data to be recorded as needed.
- Select the recording **Number** of the parameter activated based on the Signature flowmeter configuration.

Fifo Memory (Advanced Setting)

By default, when the logger memory is full, data are deleted in chronological order of recording, from oldest to newest.

- Click  to display advanced settings.
- If Fifo memory is disabled, change the maximum number of timestamps for the main memory (used for sending data via Internet) and the auxiliary memory (used for sending data via SMS) if necessary.

Maximum records

SMS Maximum records

Modbus configuration



These parameters must coincide exactly with the parameters expected by the controller connected to the Ijinus logger.

Configuration summary

To view the configuration summary:

- Click [SEE OVERVIEW](#) to display a summary of the configuration.

Signature Flow Meter ISCO

Datalogging every **15 mins**
 Modbus configuration : ID **2**, RTU protocol, **9600** Baud, **8** data bits, **none** parity, 1 stop bit(s)
 Recording will last for about 1 yr 5 mths / Send around 6.7 SMS each day
 Caution, the minimum requirement for the firmware of the Signature FlowMeter is 1.23

[EDIT](#)

Mapping table between DataID, channel & data

DataId	Channel	Data displayed	Units	Data Description	Data files
3	7	Debug (signed integer value)	mAh	Internal battery current consumption	*_diag.bin
6	0	Voltage	V	Instantaneous internal battery voltage (Res. 0.05 V)	*_diag.bin

Datald	Channel	Data displayed	Units	Data Description	Data files
6	1	Voltage	V	Minimum internal battery voltage reached (Res. 0.05 V)	*_diag.bin
6	2	Voltage	V	Instantaneous external battery voltage (Res. 0.05 V)	*_extbat.bin, *_extvolt.bin
12	0	Measure temperature	°C	Sensor 1 temperature measurement (Res. 0.1°C)	*_signISCO_0.bin
12	1	Measure temperature	°C	Sensor 2 temperature measurement (Res. 0.1°C)	*_signISCO_0.bin
12	2	Measure temperature	°C	Sensor 3 temperature measurement (Res. 0.1°C)	*_signISCO_0.bin
12	3	Measure temperature	°C	Sensor 4 temperature measurement (Res. 0.1°C)	*_signISCO_0.bin
15	0	Material height	mm	Sensor 1 water height	*_signISCO_0.bin
15	1	Material height	mm	Sensor 2 water height	*_signISCO_0.bin
15	2	Material height	mm	Sensor 3 water height	*_signISCO_0.bin
15	3	Material height	mm	Sensor 4 water height	*_signISCO_0.bin
17	0	GSM signal Power	dBm	GSM signal power	*_diag.bin
19	0	Date	-	POSIX time	Asynchronous data
24	0	Velocity	mm/s	Sensor 1 water velocity	*_signISCO_1.bin
24	1	Velocity	mm/s	Sensor 2 water velocity	*_signISCO_1.bin
24	2	Velocity	mm/s	Sensor 3 water velocity	*_signISCO_1.bin
24	3	Velocity	mm/s	Sensor 4 water velocity	*_signISCO_1.bin
26	0	Conductivity	µS/cm	Sensor 1 water conductivity	*_signISCO_2.bin
26	1	Conductivity	µS/cm	Sensor 2 water conductivity	*_signISCO_2.bin
26	2	Conductivity	µS/cm	Sensor 3 water conductivity	*_signISCO_2.bin
26	3	Conductivity	µS/cm	Sensor 4 water conductivity	*_signISCO_2.bin
30	0	pH	-	Sensor 1 water pH	*_signISCO_2.bin
30	1	pH	-	Sensor 2 water pH	*_signISCO_2.bin
30	2	pH	-	Sensor 3 water pH	*_signISCO_2.bin
30	3	pH	-	Sensor 4 water pH	*_signISCO_2.bin
34	0	Flow rate	m3/s	Sensor 1 water flow rate	*_signISCO_0.bin
34	1	Flow rate	m3/s	Sensor 2 water flow rate	*_signISCO_0.bin
34	2	Flow rate	m3/s	Sensor 3 water flow rate	*_signISCO_0.bin
34	3	Flow rate	m3/s	Sensor 4 water flow rate	*_signISCO_0.bin
39	0	Volume	m3	Sensor 1 water volume	*_signISCO_0.bin
39	1	Volume	m3	Sensor 2 water volume	*_signISCO_0.bin
39	2	Volume	m3	Sensor 3 water volume	*_signISCO_0.bin

Datald	Channel	Data displayed	Units	Data Description	Data files
39	3	Volume	m3	Sensor 4 water volume	*_signISCO_0.bin

9.6.9. Measurement using the Modbus protocol : Slave mode

Principle

The Modbus protocol can be used to link the logger to a PLC in order to send measured data. In this case, the logger is in "Modbus slave" mode. This option is not available if the Modbus connection is used in slave mode only ("Modbus flowmeter"). This is because the logger has only one Modbus connection, which can be used either as a Modbus master or as a Modbus slave, but it is not possible to use both connections at the same time.



As Modbus communication is based on a notion of requests and responses, it is essential that the logger remains permanently switched on in Modbus slave mode, and consequently the use of an external power supply is necessary. (See [Using a power pack](#) or [???](#)).

Settings



Prerequisite: In Avelour, the Wiji connection with the logger must be established, see [Connecting to a logger](#).

- Click on the  button to add a configuration measurement and select "Modbus output".



It is essential that these parameters coincide perfectly with the ones expected by the PLC connected to the logger.

Modbus output ✖

Modbus configuration

Slave address	- 1 +	Mode	RTU -
Baudrate	19200 ▾	Data bits	8 ▾
Parity	Aucun -	Stop bits	1 -

Data registers

? Registers table
[More informations here](#) ✖

Type of application Industry / farming ▾

VIEW RESUME

Viewing data logs

A document can be displayed by clicking on the "More information here" link. This document, called "Modbus Tables", describes the address, offset, size and encoding (integer, inverted integer, etc.) for each item of data measured by an Ijinus logger.

Depending on the type of application chosen from the drop-down menu shown below, the table applied (and therefore the data encoding) will not be the same. It is therefore essential to use the correct register table to be able to send the desired measurements to the PLC via the Modbus protocol.

Configuration summary

- Click on the "View resume" button to display the summary of the recording configuration.

Depending on the settings selected, the remaining recording time before the memory is full is given as well as an average of the number of sms sent per day.

Modbus output 

Modbus hub **configured, Industry / farming** profile

- Slave address = **1**
- Modbus **RTU**
- **19200** Baud
- **8** data bits
- **None** parity
- **1** stop bit(s)

Caution ! This application needs an external power supply between 8 and 30 V (wiring pins 1,2 = V+,GND)

EDIT

9.6.10. Modbus flow meter

Principle

The "Modbus flowmeter" measurement configuration enables data to be recorded using a flowmeter via Modbus communication, slave mode.

Flowmeter wiring



For correct operation of the flowmeter in MODBUS mode, you need to connect the ground wire. (See paragraph [Wiring](#))

Configuration



Prerequisites: In Avelour, the Wiji connection to the logger must be established, see [Connecting to a logger](#).

- Click  to add a measurement configuration and select "Modbus Flowmeter".

- Select the **Recording period** corresponding to the time between each recording (every 15 minutes for example).
- Select the type of **flow meter** connected to the logger.



List of selectable flowmeters

- Activate if necessary recording of **volume, flow, pressure, temperature, battery capacity** And **direction** parameters.

MODBUS parameter

ABB - AQUAMASTER4

Baudrate : 19200, Bit number : 8, Parity : Even, Stop bit : 1

For wiring, refer to the paragraph [???](#)

ARAD - OCTAVE

Baudrate : 9600, Bit number : 8, Parity : Even, Stop bit : 1

For wiring, refer to the paragraph [la section intitulée « Octave »](#)

ENLESS+HAUSER - PROMAG W800

Baudrate : 9600, Bit number : 8, Parity : Even, Stop bit : 1

For wiring, refer to the paragraph [la section intitulée « Octave »](#)

FUJI ELECTRIC - M5000

Baudrate : 9600, Bit number : 8, Parity : Even, Stop bit : 1

For wiring, refer to the paragraph [_M5000](#)

KROHNE - WATERFLUX 3070

Baudrate : 9600, Bit number : 8, Parity : Even, Stop bit : 1

For wiring, refer to the paragraph [_3070](#)

SIEMENS - MAG 8000

Baudrate : 19200, Bit number : 8, Parity : Even, Stop bit : 1

For wiring, refer to the paragraph [_MAG8000](#)

Modbus slave ID (Advanced parameter)

To enter the Modbus slave ID:

- Click  to display advanced settings.

ID esclave ModBus

- 1 +

Flow calculation

If an hourly flow is activated then it is possible to calculate this hourly volume.

- Enter start and end times.
- Activate if necessary the type of calculation recorded: an **average**, a **minimum** flow rate and/or a **maximum** flow rate.



Check sensor operation

- Click  to view measured values.
-> Connection to the device is initiated and a new window displays the measured values.

Fifo memory

By default, when the logger's memory is full, data is deleted in chronological order of recording, from oldest to most recent.

- If Fifo memory is disabled, define a maximum number of timestamps.



Configuration summary

To view the configuration summary:

- Click on [SEE OVERVIEW](#) to display a summary of the configuration.



Table of datatype correspondences

This file contains, for each brand of flow meter, the correspondence between the type of data recorded (volume, flow rate, pressure, etc.) and the number encoded by the Ijinus logger (datatype). As several identical types of data can be recorded, a channel number is also added to the datatype.

MAG 8000

Displayed Data	DatalD	Channel	Unités	Description	Data Files
Modbus register	21	20	-	Fault status	*_mag8000.bin
Modbus register	21	21	-	Configuration	*_mag8000.bin
Velocity	24	20	mm/s	Velocity	*_mag8000.bin
Flow rate	34	20	m³/s	Flow rate	*_mag8000.bin
Volume	39	20	m³	Forward volume 1	*_mag8000.bin
Volume	39	21	m³	Reverse volume 2	*_mag8000.bin
Volume	39	22	m³	Forward volume 2	*_mag8000.bin
Volume	39	24	m³	Total volume 1	*_mag8000.bin

Debug (signed integer value)	3	20	m ³	Forward volume 1 (integer m ³)	*_mag8000.bin
Debug (signed integer value)	3	21	m ³	Reverse volume 1 (integer m ³)	*_mag8000.bin
Debug (signed integer value)	3	22	m ³	Forward volume 2 (integer m ³)	*_mag8000.bin
Debug (signed integer value)	3	24	m ³	Total volume 1 (integer m ³)	*_mag8000.bin
Debug (positive integer value)	2	22	%	Flowmeter battery charge state	*_mag8000.bin
Counter	22	26	-	Hour of minimum night flow rate	*_min-fm.bin
Counter	22	27	-	Hour of maximal night flow rate	*_max-fm.bin
Volume	39	25	m ³	Hourly volume	*_hourlyflow-fm.bin
Volume	39	26	m ³	Minimum night flow rate	*_min-fm.bin
Volume	39	27	m ³	Maximum night flow rate	*_max-fm.bin
Volume	39	28	m ³	Average flow rate	*_moy-fm.bin
Volume	39	30	m ³	24-hour volume	*_dailyflow-fm.bin
Volume	39	31	m ³	Weekly volume	*_weeklyflow-fm.bin
Volume	39	32	m ³	Monthly volume	*_monthlyflow-fm.bin
State	0	20	-	Threshold state change	*_thres-event-fm.bin
Debug (signed integer value)	3	7	mAh	Internal battery current capacity consumption	*_diag.bin
GSM signal Power	17	0	dBm	GSM signal power	*_diag.bin
Voltage	6	0	V	Instantaneous battery voltage (Res. 0.05 V)	*_diag.bin
Voltage	6	1	V	Minimum battery voltage reached (Res. 0.05 V)	*_diag.bin

Waterflux 3070

Displayed Data	DataID	Channel	Unités	Description	Data Files
Debug (positive integer value)	2	20	-	Flow direction	*_waterflux.bin

Debug (positive integer value)	2	21	-	Alarms	*_waterflux.bin
Debug (Real value)	4	20	Ah	Remaining flowmeter battery capacity	*_waterflux.bin
Temperature	12	20	°C	Liquide temperature (Res. 0.1 °C)	*_waterflux.bin
Velocity	24	20	mm/s	Velocity	*_waterflux.bin
Flow rate	34	20	m ³ /s	Flow rate	*_waterflux.bin
Pressure	37	20	bar	Liquid pressure	*_waterflux.bin
Volume	39	20	m ³	Forward volume	*_waterflux.bin
Volume	39	21	m ³	Reverse volume	*_waterflux.bin
Volume	39	24	m ³	Total volume	*_waterflux.bin
Counter	22	26	-	Hour of minimum night flow rate	*_min-fm.bin
Counter	22	27	-	Hour of maximal night flow rate	*_max-fm.bin
Volume	39	25	m ³	Hourly volume	*_hourlyflow-fm.bin
Volume	39	26	m ³	Minimum night flow rate	*_min-fm.bin
Volume	39	27	m ³	Maximum night flow rate	*_max-fm.bin
Volume	39	28	m ³	Average flow rate	*_moy-fm.bin
Volume	39	30	m ³	24-hour volume	*_dailyflow-fm.bin
Volume	39	31	m ³	Weekly volume	*_weeklyflow-fm.bin
Volume	39	32	m ³	Monthly volume	*_monthlyflow-fm.bin
State	0	20	-	Threshold state change	*_thres-event-fm.bin
Debug (signed integer value)	3	7	mAh	Internal battery current capacity consumption	*_diag.bin
GSM signal Power	17	0	dBm	GSM signal power	*_diag.bin
Voltage	6	0	V	Instantaneous battery voltage (Res. 0.05 V)	*_diag.bin
Voltage	6	1	V	Minimum battery voltage reached (Res. 0.05 V)	*_diag.bin

M5000

Displayed Data	DataID	Channel	Unités	Description	Data Files
Modbus register	21	20	-	Fault	*_m5000.bin
Modbus register	21	21	-	Flow direction	*_m5000.bin
Velocity	24	20	mm/s	Velocity	*_m5000.bin
Flow rate	34	20	m ³ /s	Flow rate	*_m5000.bin
Volume	39	20	m ³	Forward volume 1	*_m5000.bin
Volume	39	21	m ³	Reverse volume 1	*_m5000.bin
Volume	39	22	m ³	Forward volume 2	*_m5000.bin
Volume	39	23	m ³	Reverse volume 2	*_m5000.bin
Volume	39	24	m ³	Total volume	*_m5000.bin
Counter	22	26	-	Hour of minimum night flow rate	*_min-fm.bin
Counter	22	27	-	Hour of maximal night flow rate	*_max-fm.bin
Volume	39	25	m ³	Hourly volume	*_hourlyflow-fm.bin
Volume	39	26	m ³	Minimum night flow rate	*_min-fm.bin
Volume	39	27	m ³	Maximum night flow rate	*_max-fm.bin
Volume	39	28	m ³	Average flow rate	*_moy-fm.bin
Volume	39	30	m ³	24-hour volume	*_dailyflow-fm.bin
Volume	39	31	m ³	Weekly volume	*_weeklyflow-fm.bin
Volume	39	32	m ³	Monthly volume	*_monthlyflow-fm.bin
State	0	20	-	Threshold state change	*_thres-event-fm.bin
Debug (signed integer value)	3	7	mAh	Internal battery current capacity consumption	*_diag.bin
GSM signal Power	17	0	dBm	GSM signal power	*_diag.bin
Voltage	6	0	V	Instantaneous battery voltage (Res. 0.05 V)	*_diag.bin
Voltage	6	1	V	Minimum battery voltage reached (Res. 0.05 V)	*_diag.bin

PROMAG w 800

Displayed Data	DataID	Channel	Unités	Description	Data Files
----------------	--------	---------	--------	-------------	------------

Debug (positive integer value)	2	20	%	Flowmeter battery charge state	*_promag.bin
Debug (positive integer value)	2	21	days	Estimated flowmeter battery lifetime	*_promag.bin
Velocity	24	20	mm/s	Velocity	*_promag.bin
Conductivity	26	20	μS/cm	Conductivity	*_promag.bin
Flow rate	34	20	m ³ /s	Flow rate	*_promag.bin
Volume	39	20	m ³	Forward volume	*_promag.bin
Volume	39	21	m ³	Reverse volume	*_promag.bin
Volume	39	24	m ³	Total volume	*_promag.bin
Counter	22	26	-	Hour of minimum night flow rate	*_min-fm.bin
Counter	22	27	-	Hour of maximal night flow rate	*_max-fm.bin
Volume	39	25	m ³	Hourly volume	*_hourlyflow-fm.bin
Volume	39	26	m ³	Minimum night flow rate	*_min-fm.bin
Volume	39	27	m ³	Maximum night flow rate	*_max-fm.bin
Volume	39	28	m ³	Average flow rate	*_moy-fm.bin
Volume	39	30	m ³	24-hour volume	*_dailyflow-fm.bin
Volume	39	31	m ³	Weekly volume	*_weeklyflow-fm.bin
Volume	39	32	m ³	Monthly volume	*_monthlyflow-fm.bin
State	0	20	-	Threshold state change	*_thres-event-fm.bin
Debug (signed integer value)	3	7	mAh	Internal battery current capacity consumption	*_diag.bin
GSM signal Power	17	0	dBm	GSM signal power	*_diag.bin
Voltage	6	0	V	Instantaneous battery voltage (Res. 0.05 V)	*_diag.bin
Voltage	6	1	V	Minimum battery voltage reached (Res. 0.05 V)	*_diag.bin

Octave

Displayed Data	DataID	Channel	Unités	Description	Data Files
----------------	--------	---------	--------	-------------	------------

Debug (positive integer value)	2	20	-	Flow direction	*_octave.bin
Temperature	12	20	°C	Liquid temperature (Res. 0.1 °C)	*_octave.bin
Modbus Register	21	20	-	Alarms	*_octave.bin
Flow rate	34	20	m ³ /s	Flow rate	*_octave.bin
Volume	39	20	m ³	Reverse volume 1	*_octave.bin
Volume	39	21	m ³	Forward volume 2	*_octave.bin
Volume	39	24	m ³	Total volume	*_octave.bin
Counter	22	26	-	Hour of minimum night flow rate	*_min-fm.bin
Counter	22	27	-	Hour of maximal night flow rate	*_max-fm.bin
Volume	39	25	m ³	Hourly volume	*_hourlyflow-fm.bin
Volume	39	26	m ³	Minimum night flow rate	*_min-fm.bin
Volume	39	27	m ³	Maximum night flow rate	*_max-fm.bin
Volume	39	28	m ³	Average flow rate	*_moy-fm.bin
Volume	39	30	m ³	24-hour volume	*_dailyflow-fm.bin
Volume	39	31	m ³	Weekly volume	*_weeklyflow-fm.bin
Volume	39	32	m ³	Monthly volume	*_monthlyflow-fm.bin
State	0	20	-	Threshold state change	*_thres-event-fm.bin
Debug (signed integer value)	3	7	mAh	Internal battery current capacity consumption	*_diag.bin
GSM signal Power	17	0	dBm	GSM signal power	*_diag.bin
Voltage	6	0	V	Instantaneous battery voltage (Res. 0.05 V)	*_diag.bin
Voltage	6	1	V	Minimum battery voltage reached (Res. 0.05 V)	*_diag.bin

Aquamaster

Displayed Data	DataID	Channel	Unités	Description	Data Files
Modbus register	21	20	-	Alarms	*_aqua.bin
Velocity	24	20	mm/s	Velocity	*_aqua.bin
Flow rate	34	20	m ³ /s	Flow rate	*_aqua.bin

Pressure	37	20	bar	Liquid pressure	*_aqua.bin
Volume	39	20	m ³	Forward volume	*_aqua.bin
Volume	39	21	m ³	Reverse volume	*_aqua.bin
Volume	39	24	m ³	Total volume	*_aqua.bin
Counter	22	26	-	Hour of minimum night flow rate	*_min-fm.bin
Counter	22	27	-	Hour of maximal night flow rate	*_max-fm.bin
Volume	39	25	m ³	Hourly volume	*_hourlyflow-fm.bin
Volume	39	26	m ³	Minimum night flow rate	*_min-fm.bin
Volume	39	27	m ³	Maximum night flow rate	*_max-fm.bin
Volume	39	28	m ³	Average flow rate	*_moy-fm.bin
Volume	39	30	m ³	24-hour volume	*_dailyflow-fm.bin
Volume	39	31	m ³	Weekly volume	*_weeklyflow-fm.bin
Volume	39	32	m ³	Monthly volume	*_monthlyflow-fm.bin
State	0	20	-	Threshold state change	*_thres-event-fm.bin
Debug (signed integer value)	3	7	mAh	Internal battery current capacity consumption	*_diag.bin
GSM signal Power	17	0	dBm	GSM signal power	*_diag.bin
Voltage	6	0	V	Instantaneous battery voltage (Res. 0.05 V)	*_diag.bin
Voltage	6	1	V	Minimum battery voltage reached (Res. 0.05 V)	*_diag.bin

9.6.11. Measurement with a 4-20 mA piezoresistive sensor + external speed sensor

Principle



This measure is used to configure data retrieval from a piezoresistive sensor to a data logger via a 4-20 mA signal.

Configuration



Prerequisites: In Avelour, the Wiji connection to the logger must be established, see [Connecting to a logger](#).

- Click  to add a measurement configuration and select "Piezo 4-20mA + external velocity -> flow".

Piezo 4/20mA + external velocity -> Flow
 

Measure period 15 mn ▾

On
Power the external probe

[Go to power configuration menu](#)

No external power

Power duration - 250.00 ms +

First 4-20mA channel

Peripheral 4-20mA Input (18) ▾

Conversion

Value at 4mA - 0.00 +	Value at 20mA - 0.00 +
Offset on conversion - 0.00 +	Do not convert values if less than 4mA <input checked="" type="checkbox"/> On

Adjustment value 0mm ⚡
Calibrate

(Recorded value = converted current + offset + adjustment value)

Flowrate / Volume

Velocity measuring device ▾

Verify that the choosen sensor record the velocity at the **same period** and send its data on the radio

Record velocity Off Height/surface table (empty) 📄 Fill table

Off Sampler enslaving

Off Set a threshold

VIEW RESUME

Measure period

- From the list, select a length of time between each measurement. In the example above, a measurement will be taken every 15 minutes.

External sensor power supply

By default, sensor power supply is activated . If the sensor is already powered by a source other than the logger, then deactivate.

If the external sensor is powered by the logger, it is possible to use either the internal battery (within the limit of 5 to 18 V and 1.8 Watt maximum) or to connect an external battery between the logger and the sensor. In this case, you need to configure the logger by clicking on the "Go to power management block" link. The configuration of power supply options is described in this document in paragraph [Using a power pack](#).

Whether the sensor is powered by the internal battery or via an external battery, it is essential to determine the power supply duration. This is the time during which the sensor will be powered by the logger before measuring the 4-20 mA signal emitted by the external sensor.

- If this time is too short, then the measured 4-20 mA signal will not be good and the measured value may be slightly or even extremely different from that actually expected.
- If the time is too long, the measured 4-20 mA signal will be correct, but the battery life will be reduced due to excessive power consumption.

It is not possible to specify a power supply period, as this can vary from 25 ms for some piezometric sensors to several tens of seconds for some water level sensors. The default value has been set at 250 ms, as this period is used to power the 4-20 mA piezometers sold by Ijinus.



For the inclinometer sold by Ijinus, the minimum power supply period is 500 ms.

First 4-20 mA channel

- Select one of the two 4-20mA inputs for the **Peripheral**.

4-20 mA signal conversion

- **Value at 4 mA** : enter the minimum value (usually 0) of the connected sensor.
- **Value at 20 mA** : enter the full-scale value of the connected sensor.
- **Offset on conversion** : enter an offset if required for the measurement.
- By default, **Do not convert values if less than 4 mA** is activated .
- Enter an **adjustment value** to calibrate the connected sensor.

Height / Flow relationship

- Select the **Velocity measuring device** in the list.
- Verify that the chosen sensor record the velocity at the **same period** and send its data on the radio
- Click on the "Enter table" button to enter a height/flow table, so that the logger can transform the 4-20 mA signal into a water height, and then transform the water height into a flow rate.



Make sure you respect the units indicated in the table (mm or m and m³/s or m³/h).

Flowrate / Volume

Velocity measuring device ▼

Verify that the chosen sensor record the velocity at the **same period** and send its data on the radio

Record velocity Off

Height/surface table (empty) ⌘ Fill table

Sampler enslaving

On **Sampler enslaving**

Pulse output peripheral Open-drain Output (22) ▼

Force one pulse ⚡ Execute

Enslaving condition Height over a high-level threshold (mm) ▼

Threshold - 100.00 + **Hysteresis** - 0.00 +

Delay before activation 0 h 0 min 0 sec **Delay before deactivation** 0 h 0 min 0 sec

Enslaving criterion Volume ▼

Volume enslaving - 1.000 m³ +

If a height / flow relationship and an "infinite" volume calculation have been entered, then it is possible to activate ● the transmission of pulses to a sampler connected to an Ijinus logger.

- Select the **pulse output device**.
- Click the ⚡ button next to the "Force a pulse" line to test the connection between the logger and the sampler. When you click this button, the logger sends a pulse to the Open-Drain output, which must be detected by the connected sampler.
- Select the **slaving condition** : either on a water height or on the flow rate.

If a condition is selected:

- Enter a **threshold** in mm and a **hysteresis** in mm for this condition. The **Hysteresis** parameter defines a value to be subtracted from or added to the threshold for which the condition remains true.

Example: In the case of an enslaved condition with a height below a high threshold of 100 mm and a hysteresis of 5 mm, the enslaved condition remains active until the height falls below 95 mm again.
- Enter a **delay** to this condition, whether pulses are activated or deactivated.

Two enslaving criteria are possible:

- Slaving to **volume** : This means that, in the example above, a pulse will be sent each time the logger has measured 1 m³ of transited volume.

- Slaving to **time** : This means that as long as the condition is active, a pulse will be sent to the sampler at the defined frequency. The measured flow rate has no effect on the number and frequency of pulses sent.



Between two measurements, the logger is in standby mode and cannot send pulses. At the time of measurement, if the logger calculates a transited volume of 5 m³ for example, then five pulses will be sent in succession. Similarly, if the pulse frequency is set to one minute, but the measurement frequency is only five minutes, no pulses will be sent between two measurements. However, every time the unit is woken and if the slaving condition is still met, five pulses will be sent to the sampler every five minutes.

Define a threshold

- **Source data** : determine whether the threshold is based on channel 1 conversion, channel 1 current or contact input.
- **Direction** : define the direction, either on a "rising edge / contact open" or a "falling edge / contact close". The delay can also be set for activation and/or deactivation.
- Activate the Open-Drain output to close a contact when the threshold is exceeded (normally open operation), or to open the contact when the threshold is exceeded (normally closed).

On
Set a threshold

Source data Current channel 1 ▾

Direction Falling edge / Closed contact ▾

Threshold - 0.00 +

Delay before activation 0 h 0 min 0 sec

Hysteresis - 0.00 +

Delay before deactivation 0 h 0 min 0 sec

Actions

Output activation Inactive Open-drain Output (15) ▾

Record an event Active Overflow (DataId = 20) ▾ Channel 0 ▾

Actions (Advanced settings)

- Click to display advanced settings.
- Activate the Open drain output to close a contact when the threshold is exceeded (normally open operation), or to open the contact when the threshold is exceeded (normally closed).
- If required, select the recording channel (between 0 and 15) and the logged event ID (20 = overflow or 0 = Boolean).

Fifo Memory (Advanced Setting)

By default, when the logger memory is full, data are deleted in chronological order of recording, from oldest to newest.

- Click to display advanced settings.
- If Fifo memory is disabled, change the maximum number of timestamps for the main memory (used for sending data via Internet) and the auxiliary memory (used for sending data via SMS) if necessary.

Maximum records - 50000 +
SMS Maximum records - 50000 +

Configuration overview

To view the configuration summary:

- Click [SEE OVERVIEW](#) to display a summary of the configuration.

Depending on the settings selected, the remaining recording time before the memory is full is given, as well as an average of the number of text messages sent per day.

Piezo 4/20mA + external velocity -> Flow 

4-20mA piezo measure every **15 mins** with velocity from external device **IJA0102-00000858**
First channel : conversion in **15**, (4mA = 0 / 20mA = 0)
Recording will last for about 1 yr 5 mths / Send around 1.9 SMS each day

[EDIT](#)

9.6.12. Measurement via 4-20 mA input

Principle

This measurement is used to configure data retrieval from a sensor connected to a logger via a 4-20 mA signal.

Configuration



Prerequisites: In Avelour, the Wiji connection to the logger must be established, see [Connecting to a logger](#).

- Click  to add a measurement configuration and select "Measurement 4 -20mA".

4-20mA measure  

Measure period

Powering the 4-20mA probes

[Go to power configuration menu](#)

No external power

Supply duration ms

First 4-20mA channel

Peripheral

Conversion

Second 4-20mA channel

Set a threshold 1

 **Test measure**
VIEW RESUME

Measure period

- From the list, select a length of time between each measurement. In the example above, a measurement will be taken every 15 minutes.

External sensor power supply

By default, sensor power supply is activated . If the sensor is already powered by a source other than the logger, then deactivate.

If the external sensor is powered by the logger, it is possible to use either the internal battery (within the limit of 5 to 18 V and 1.8 Watt maximum) or to connect an external battery between the logger and the sensor. In this case, you need to configure the logger by clicking on the "Go to power management block" link. The configuration of power supply options is described in this document in paragraph [Using a power pack](#).

Whether the sensor is powered by the internal battery or via an external battery, it is essential to determine the power supply duration. This is the time during which the sensor will be powered by the logger before measuring the 4-20 mA signal emitted by the external sensor.

- If this time is too short, then the measured 4-20 mA signal will not be good and the measured value may be slightly or even extremely different from that actually expected.
- If the time is too long, the measured 4-20 mA signal will be correct, but the battery life will be reduced due to excessive power consumption.

It is not possible to specify a power supply period, as this can vary from 25 ms for some piezometric sensors to several tens of seconds for some water level sensors. The default value has been set at 250 ms, as this period is used to power the 4-20 mA piezometers sold by Ijinus.



For the inclinometer sold by Ijinus, the minimum power supply period is 500 ms.

First 4-20 mA channel

- Select one of the two 4-20mA inputs for the **device used**.

4-20 mA signal conversion

If no conversion is configured, only the value of the 4-20 mA signal will be saved.

4-20mA measure 🗑️ 🔧

Measure period 15 mn ▾

On
Powering the 4-20mA probes

[Go to power configuration menu](#)

No external power

Supply duration - 250.00 ms +

First 4-20mA channel

Peripheral 4-20mA Input (18) ▾

On
Conversion

Convert the current in Water height (mm) ▾

Value at 4mA Water height (mm)

Offset on conversion

Adjustment value

(Recorded value = converted current)

off Flowrate / Volume

off Sampler enslaving

Value at 20mA - 0.00 +

Do not convert values if less than 4mA On

Water height (mm)

Pressure (bar)

Temperature (°C)

Angle (°)

Quantity without unit

Velocity (mm/s)

off Second 4-20mA channel

off Set a threshold 1

⚡ Test measure
VIEW RESUME

- Activate the **Conversion** to convert the 4-20 mA signal into a parameter to be selected from the drop-down menu.
- Select from the list **Convert current into** the physical value of the desired conversion unit.
- **Value at 4 mA** : Enter the minimum value (usually 0) of the connected sensor.
- **Value at 20 mA** : Enter the full-scale value of the connected sensor.
- **Offset on conversion** : Enter conversion offset (offset unit according to selected conversion unit)
- The **do not convert current values below 4 mA** option allows conversion to the indicated value at 4 mA (in the example below: 0 bar) whether the current is measured at 0 mA, 2 mA or 3.99 mA.
- To convert current to height, enter an **adjustment value** to calibrate the connected sensor (height offset, for example).

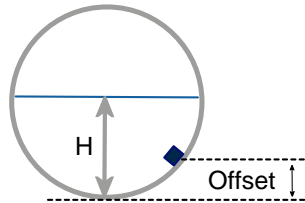

There are two main types of conversion: water height conversion and other types of conversion. In fact, conversion to water height enables flow/volume calculation options, as well as the enslavement of a sampler.



This option is rarely used for drinking water network diagnostics. However, as this is a feature common to all sanitation range data loggers, the possibility of converting the 4-20 mA signal into water height is presented below.

Example of water height conversion

In the example below, the 4-20 mA sensor is a 0-10 m (10,000 mm) range piezometer.

First 4-20mA channel

Peripheral: 4-20mA Input (18)

Conversion

Convert the current in: Water height (mm)

Value at 4mA:

Value at 20mA:

Offset on conversion:

Do not convert values if less than 4mA:

Adjustment value: 0mm

(Recorded value = converted current + offset + adjustment value)

Off Flowrate / Volume

Off Sampler enslaving

Height / Flow relationship

These options are only available if the 4-20 mA signal is converted to water height.

- Click on the "enter table" button to populate a height/flow table so that the logger can transform the 4-20 mA signal into a water height, and then transform the water height into a flow rate.



Make sure you respect the units indicated in the table (mm or m and m³/s or m³/h).

- Activate the **cumulative volume** to transform flow rates into transited volume. It is then possible to record a cumulative hourly, daily or monthly volume.
- Activate the **infinite accumulation** if required.

The  "Execute" button resets the infinite accumulation to 0 if necessary.

On
Flowrate / Volume

Height/flowrate table (2 lines)

Cumulated volume Active Hourly

Record infinite accumulation On

Fill table

Reset the infinite counter  Execute

Sampler enslaving

On
Sampler enslaving

Pulse output peripheral Open-drain Output (22)

Force one pulse  Execute

Enslaving condition Height over a high-level threshold (mm)

Threshold - 100.00 + Hysteresis - 0.00 +

Delay before activation 0 h 0 min 0 sec Delay before deactivation 0 h 0 min 0 sec

Enslaving criterion Volume

Volume enslaving - 1.000 m³ +

If a height / flow relationship and an "infinite" volume calculation have been entered, then it is possible to activate the transmission of pulses to a sampler connected to an Ijinus logger.

- Select the **pulse output device**.
- Click the  button next to the "Force a pulse" line to test the connection between the logger and the sampler. When you click this button, the logger sends a pulse to the Open-Drain output, which must be detected by the connected sampler.
- Select the **slaving condition** : either on a water height or on the flow rate.

If a condition is selected:

- Enter a **threshold** in mm and a **hysteresis** in mm for this condition. The **Hysteresis** parameter defines a value to be subtracted from or added to the threshold for which the condition remains true.

Example: In the case of an enslaved condition with a height below a high threshold of 100 mm and a hysteresis of 5 mm, the enslaved condition remains active until the height falls below 95 mm again.

- Enter a **delay** to this condition, whether pulses are activated or deactivated.

Two enslaving criteria are possible:

- Slaving to **volume** : This means that, in the example above, a pulse will be sent each time the logger has measured 1 m³ of transited volume.
- Slaving to **time** : This means that as long as the condition is active, a pulse will be sent to the sampler at the defined frequency. The measured flow rate has no effect on the number and frequency of pulses sent.



Between two measurements, the logger is in standby mode and cannot send pulses. At the time of measurement, if the logger calculates a transited volume of 5 m³ for example, then five pulses will be sent in succession. Similarly, if the pulse frequency is set to one minute, but the measurement frequency is only five minutes, no pulses will be sent between two measurements. However, every time the unit is woken and if the slaving condition is still met, five pulses will be sent to the sampler every five minutes.

Converting current to pressure, temperature, angle, speed or unitless value

For other types of conversion, the options are the same as for the conversion to bar shown below.

In the example below, the 4-20 mA sensor is a 0-25 bar range sensor. It is possible to adjust the actual measurement to a reference measurement, using the offset on the conversion.

- The **do not convert current values below 4 mA** option allows conversion to the indicated value at 4 mA (in the example below: 0 bar) whether the current is measured at 0 mA, 2 mA or 3.99 mA.

On Conversion			
Convert the current in	Pressure (bar)		
Value at 4mA	- 0.00 +	Value at 20mA	- 25.00 +
Offset on conversion	- 0.00 +	Do not convert values if less than 4mA	On

Example of pressure conversion (bar)

Second 4-20 mA channel

A second 4-20 mA sensor can be added to the logger. The options and possibilities are identical to those already presented ([the section called "First 4-20 mA channel"](#)) for the first 4-20 mA sensor.

Set threshold 1

In this example, the threshold is based on the conversion of channel 1 to "rising edge" for the direction. The delay can also be set for activation and/or deactivation.

- Activate the **acceleration** and enter the new period to accelerate the period between measurements,
- Activate the Open-Drain output to close a contact when the threshold is exceeded (normally open operation), or to open the contact when the threshold is exceeded (normally closed).

On **Set a threshold 1**

Source data	<input type="text" value="Current channel 1"/>		
Direction	<input type="text" value="Falling edge / Closed contact"/>		
Threshold	<input type="text" value="100.00"/>	Hysteresis	<input type="text" value="0.00"/>
Delay before activation	<input type="text" value="0"/> h <input type="text" value="0"/> min <input type="text" value="0"/> sec	Delay before deactivation	<input type="text" value="0"/> h <input type="text" value="0"/> min <input type="text" value="0"/> sec

Actions

Acceleration	<input checked="" type="checkbox"/> Active	<input type="text" value="Stop"/>	
Output activation	<input checked="" type="checkbox"/> Active	<input type="text" value="Open-drain Output (22)"/>	Polarity <input type="text" value="Normally opened"/>
Record an event	<input type="checkbox"/> Inactive	<input type="text" value="Overflow (DataId = 20)"/>	

Set threshold 2

It is possible to set a second threshold for which neither the measurement acceleration option nor the option to activate the Open-Drain output is available.

Fifo Memory (Advanced Setting)

By default, when the logger memory is full, data are deleted in chronological order of recording, from oldest to newest.

- Click  to display advanced settings.
- If Fifo memory is disabled, change the maximum number of timestamps for the main memory (used for sending data via Internet) and the auxiliary memory (used for sending data via SMS) if necessary.

Maximum records	<input type="text" value="50000"/>	SMS Maximum records	<input type="text" value="50000"/>
-----------------	------------------------------------	---------------------	------------------------------------

Configuration summary

To view the configuration summary:

- Click SEE OVERVIEW to display a summary of the configuration.

Depending on the settings selected, the remaining recording time before the memory is full is given, as well as an average of the number of text messages sent per day.

4-20mA measure 

4-20mA measure every **15 mins**

First channel : conversion in **Water height (mm)**, (4mA = 0 / 20mA = 10000) , recording of **flowrate** + cumulated volume every **1 hr + infinite** volume accumulation, **sampler enslaving** every **1 m3**

No second channel

Threshold 1: Current channel 1 on the criteria : **above 100** with an **hysteresis 0** .

- output activation.

Recording will last for about 1 yr 5 mths / Send around 5.3 SMS each day

 Test measure
EDIT

Correspondence chart between DataID, channel & data

Data	Channel	Data displayed	Units	Data Description	Data files
0	0-15	State	-	Threshold event recording - Channel 1	*_event.bin
0	0-15	State	-	Threshold event recording - Channel 2	*_event-2.bin
3	7	Debug (signed integer value)	mAh	Internal battery current consumption	*_diag.bin
4	0	Debug (Real value)	-	Conversion of current into quantity without unit - Channel 1	*_cu.bin
4	1	Debug (Real value)	-	Conversion of current into quantity without unit - Channel 2	*_cu.bin
6	0	Voltage	V	Instantaneous internal battery voltage (Res. 0.05 V)	*_diag.bin
6	1	Voltage	V	Minimum internal battery voltage reached (Res. 0.05 V)	*_diag.bin
6	2	Voltage	V	Instantaneous external battery voltage (Res. 0.05 V)	*_extvolt.bin, *_extbat.bin
10	0	Current	mA	Current signal (Res. 0.01 mA) - Channel 1	*_cu.bin
10	1	Current	mA	Current signal (Res. 0.01 mA) - Channel 2	*_cu.bin
12	0	Measure temperature	°C	Conversion of current into temperature - Channel 1	*_cu.bin
12	1	Measure temperature	°C	Conversion of current into temperature - Channel 2	*_cu.bin
15	0	Material height	mm	Conversion of current into water height - Channel 1	*_cu.bin
15	1	Material height	mm	Conversion of current into water height - Channel 2	*_cu.bin
17	0	GSM signal Power	dBm	GSM signal power	*_diag.bin
19	0	Date	-	POSIX time	Asynchronous data
20	0-15	Overflow	-	Threshold event recording - Channel 1	*_event.bin
20	0-15	Overflow	-	Threshold event recording - Channel 2	*_event-2.bin
24	0	Velocity	mm/s	Conversion of current into velocity - Channel 1	*_cu.bin
24	1	Velocity	mm/s	Conversion of current into velocity - Channel 2	*_cu.bin
34	0	Flow rate	m ³ /s	Flow rate calculation - Channel 1	*_flow1.bin
34	1	Flow rate	m ³ /s	Flow rate calculation - Channel 2	*_flow2.bin

Data	Channel	Data displayed	Units	Data Description	Data files
37	0	Pressure	bar	Conversion of current into pressure - Channel 1	*_cu.bin
37	1	Pressure	bar	Conversion of current into pressure - Channel 2	*_cu.bin
39	0	Volume	m ³	Cumulated volume over the defined period - Channel 1	*_volcount1.bin
39	1	Volume	m ³	Infinite accumulation of volume - Channel 1	*_flow1.bin
39	2	Volume	m ³	Cumulated volume over the defined period - Channel 2	*_volcount2.bin
39	3	Volume	m ³	Infinite accumulation of volume - Channel 2	*_flow2.bin
44	0	Angle	°	Conversion of current into angle - Channel 1	*_cu.bin
44	1	Angle	°	Conversion of current into angle - Channel 2	*_cu.bin

9.7. Configuring the sending data

9.7.1. Technologies used

Different methods of data transmission are possible, such as SMS messages or Internet communication using FTP(s), HTTP(s) or CoAP protocols. For this, several technologies can be used: 2G, 3G, LTE-M, NB-IoT and MQTT(s).

The use of a communication PCB is possible to transmit data over LoRaWAN.



NB-IoT technology does not allow data to be sent by SMS.

A very important factor in data transmission is the quality of the telephone operator's signal at the location where the logger is installed. Depending on how the logger is installed, signal quality may be degraded, for example if the logger is placed in a manhole closed by a metal cover.



The quality of the signal during data transmission has an impact on the logger's battery life. Indeed, the poorer the signal quality, the higher the energy consumption needed for transmission.

9.7.2. Signal quality: Mobile Signal Strength Value

Signal strength (dBm)	Signal quality
+ 49 dBm	Default value that may indicate a network connection problem
- 70 to -80 dBm	Very good quality
- 80 to -90 dBm	Good quality
- 90 to -100 dBm	Average quality

Signal strength (dBm)	Signal quality
- 100 to - 105 dBm	Poor signal quality
+ 113 dBm	No communication possible

9.7.3. Configuring the modem of the communication card



Prerequisites: A SIM card with a “voice” or SMS message package must be inserted into the holder. See paragraph [Inserting a SIM card](#) parameters.

Before being able to send data by SMS or M2M, you must configure the modem on the communication board.

- In the “Data sending” block, click “EDIT”.

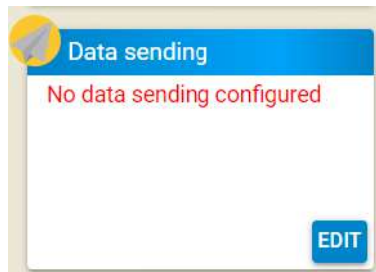

-> The data transmission parameter editing window is displayed.

Mesures
Data sending 

Modem options

 The 'PINcode' and 'APN' fields **needs to be recorded in the modem chip**.
Once you filled the fields, you have to **Click on the button** to record them in the modem chip and test the connection.

- The SIM code is specific to the SIM card and must be set if the SIM card is locked.
Beware, you have only 3 tries !
- The APN allows the modem to connect to the Internet and is specific to your phone operator.
In the advanced parameters, you'll also find PPP parameters that could be needed by your operator.
- The PIN code and the APN are recorded directly in the modem chip and **can disappear** after a device reset even if they are still active in the modem chip.
Also, **If you change the SIM card**, remember to set these fields

Technology to use

PIN code Inactive APN

Use an external Antenna Off

⚡ 1 : Program modem

⚡ 2: Diagnostic modem

Off Internet data sending

Off SMS data sending

Alert parameters

Minimum time between two data sending h min sec

Off Send alert SMS

CLOSE

Technology to use

- Choose the technology used.

This could be 2G, 3G, LTE-M, or NB-IoT technology. For 3G, LTE-M and NB-IoT technologies, you can choose an option where 2G technology will be used as a backup if the selected technology is not available.



The selected technology must be compatible with the SIM card inserted in the logger and with the relay antennas located near the logger.

PIN code

- Enter a value in the field if the SIM card is protected by a PIN code.



Only 3 attempts are possible before the SIM card is blocked.

APN

- If the data is sent in M2M (by FTP (S) or CoAP), configure the APN of the SIM card. Hover the mouse over the question mark to display a list of the APN of some telephone operators.
- If a private APN with password is used, click on the icon  at the top right of the application to switch to advanced settings.

-> New options appear including fields, where necessary, to specify the username (PPP User) and the password (PPP Password).

- Activate the parameter to enter values in empty fields.

Technology to use	<input type="text" value="2G"/>	Priority operator 	<input type="checkbox"/> Inactive	<input type="text" value="20801"/>
PIN code	<input type="checkbox"/> Inactive	<input type="text" value="APN"/>		
PPP phone	<input type="checkbox"/> Inactive	PPP user	<input type="checkbox"/> Inactive	<input type="text"/>
PPP password	<input type="checkbox"/> Inactive	Use an external Antenna	<input type="checkbox"/> Off	
⚡ 1 : Program modem				
⚡ 2: Diagnostic modem				
Modem connection timeout	<input type="checkbox"/> Inactive	<input type="text" value="120"/>		

Priority operator (Multi-operator SIM)



This feature requires a firmware update (22.1 or later). Refer to paragraph [Firmware update](#).

This feature can only be used with a multi-operator SIM card.

In the case of a multi-operator SIM card, each time a data transmission occurs, a search for a connection to one of the available networks is launched randomly. If after 60 seconds, the attempt to connect to a network fails due to lack of signal strength, the SIM card then attempts to connect to another available network and therefore consumes electrical power.

To prevent the SIM card from attempting to connect to a network with excessively low signal strength, you can specify a priority operator network by entering its MCC + MDC code. (20820: Bouygues, 20801: Orange, 20810: SFR).

To define the priority operator, preferably the one with the highest signal strength at the measurement point, it is advisable to test the signal strength of all operators to determine which one to use in priority. To do this:

- Apply measurement conditions.
- Activate "Priority operator" and enter the operator code of the network to test. (20820: Bouygues, 20801: Orange, 20810: SFR)
- Click "Program modem".

- Click “Diagnostic Modem” and view the signal strength value. Refer to paragraph [Signal quality: Mobile Signal Strength Value](#) parameters.
- Repeat the procedure for all mobile network operators to determine the optimal operator for the measurement site.

Program modem

When the Modem parameters have been configured:

- Click on the button  “1: Program modem”.



You must click the “1: Program modem” button to send data to the modem; simply saving the configuration does not allow you to configure the modem.



1 : Program modem

-> Programming the modem takes a few minutes. When the configuration is complete, a window opens to indicate the result:



-> If the programming did not occur correctly, a window opens to indicate the problem encountered (SIM card absent, incorrect PIN code, etc.)

- Each time a parameter is modified (e.g. change of technology), click on the “1: Program modem” button.

9.7.4. Check network quality: Modem diagnostics

After setting up the Modem, you need to make sure that a communication network is available.

- Click the button "2: Modem diagnostic".



-> the communication PCB boots up and searches for a mobile network signal. A window opens to display the results

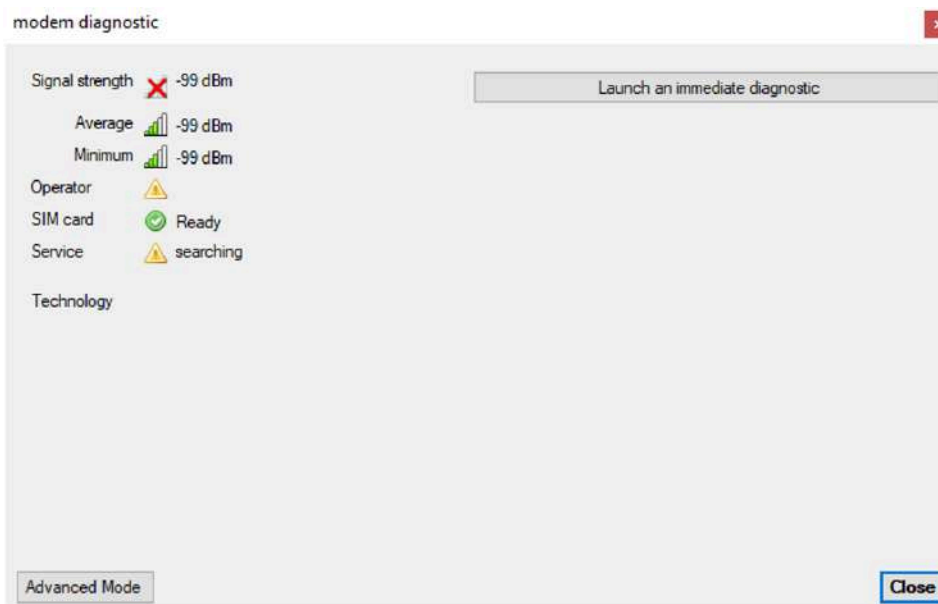

"Modem Status" window -

If the result is as shown above, it means that no signal has been located.

- Click the "Launch an immediate diagnostic" button to give the modem more time to detect a network. In less than a minute, a satisfactory result should appear as indicated below:

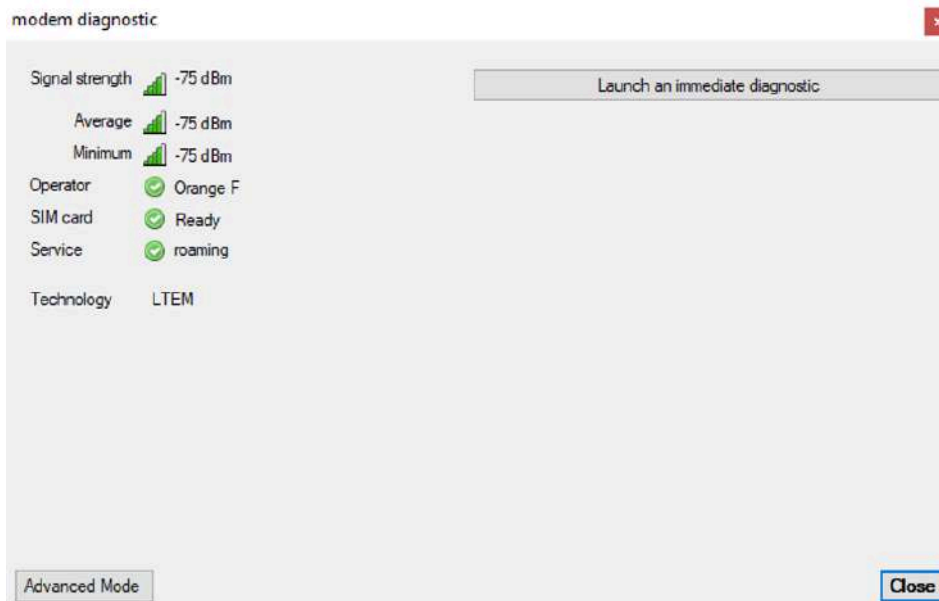

If after 5 minutes of searching the result is not satisfactory, it means that there is a problem with connecting to the network. Several cases are possible:

Problem	Corrective action
No network is available for the selected technology.	<ul style="list-style-type: none"> Select another communication technology if the SIM card allows it, then click on the "1: program modem" button
No network is available for the SIM card operator	<ul style="list-style-type: none"> Use a multi-carrier SIM card or a SIM card from another carrier
No network is available for any technology.	<ul style="list-style-type: none"> Place the external antenna connected to the logger in a location where communication is more favorable. For example, if the antenna was placed in a manhole or facility, move it outside.
SIM card is not activated	<ul style="list-style-type: none"> Check with the SIM card provider that it has been activated.



Pay attention to the scope of validity of the SIM card. Some SIM cards may be limited to certain countries or continents depending on the subscription purchased.

By using the advanced mode, it is possible to perform continuous signal strength measurements over a longer period of time. This option can be used to set the best position of the antenna before drilling a hole in the manhole to offset the antenna from the metal cover.

9.7.5. Data sending in FTP(s)

- Insert a SIM card (with a data package of at least 5 MB per month) into the holder. See paragraph [Inserting the SIM card](#).
- When purchasing a SIM card, ask for the operator's APN and PIN code, if available, as this information will be needed.
- Connect the GSM / GPRS antenna to the connector on top of the logger.
- In Avelour, activate  **Data sending via Internet: FTP / CoAP**

- Select the data **transmission cycle**.

By default, the logger is programmed to send data to Ijitrack. In this case, no modification to the existing configuration is required.

- If you do not have an Ijitrack account, please contact our customer service department.



You will be asked to provide the product number on the logger label and the installation address.

- If data is being sent to a server other than Ijitrack, click on the  icon in the top right of the screen to go to advanced settings and display the following parameters:

- If necessary, contact the FTP server administrator to obtain the three parameters required to send data to a server:
 - Server name or IP address: "Server"
 - Name of user accessing the server: "Username"

- Password associated with the user: "Password"
- Click on the  **FTP data transmission test** button to check that data transmission is working correctly.



-> If data is transmitted, the following window appears:

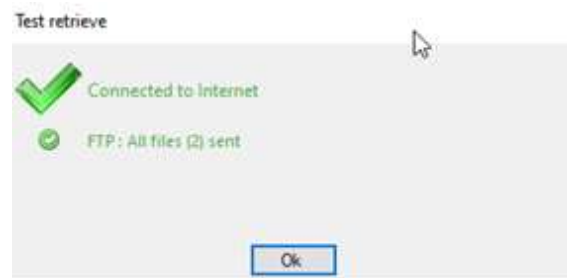

- After a few minutes, check that the data has arrived on the Ijitrack account or on a different Ijitrack server.

9.7.6. Data sending in Http(s)



Requires firmware version later than or equal to 22.04.

Configuration

Under “Internet data sending”,

- Activate **Internet data sending** and select the HTTP protocol,

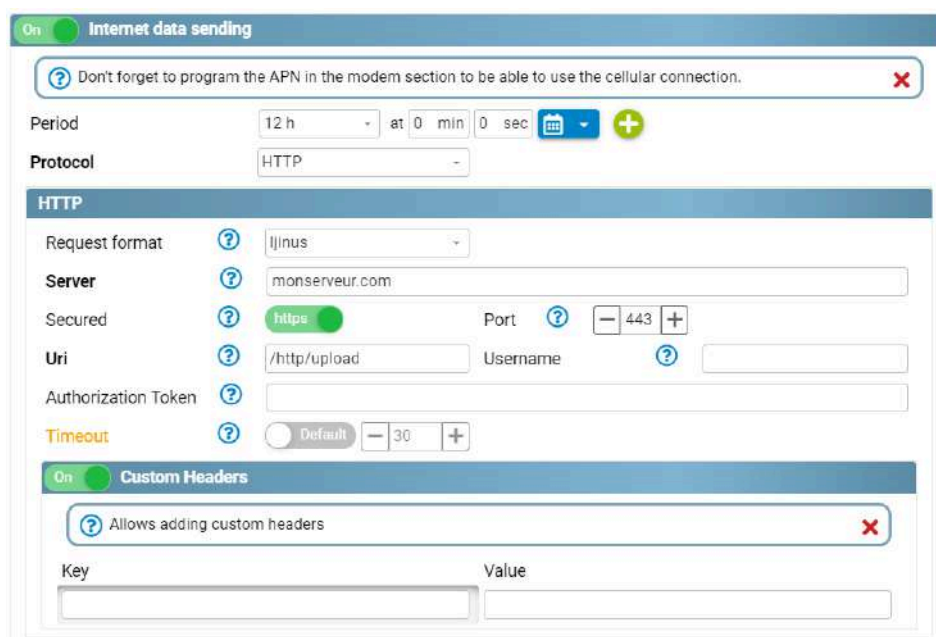

Sending data via HTTPS in ijinus format

- **Request format:** Ijinus, Topkapi, Azure IoT Hub.
 - **Ijinus:** Ijinus is a format that allows interoperability with most systems. It is fairly generic and contains all the information you might need. Moreover, custom values can also be added in the header.
 - **Topkapi:** Specific format for compatibility with Topkapi.
 - **Azure IoT Hub:** Format for compatibility with the Azure platform.
- **Server:** Enter the URL of the target server (without http/https). For ijinus, the server is files.ijitrack.com.
- **Port:** Enter the HTTP listening port on the server side.
- **Secure:** HTTP or HTTPS.
- **Uri :** Enter the url of the http request. Not available for ijinus format with files.ijitrack.com server.
- **User name:** With Ijinus format. If needed. It will be included in the body of the request in the user form. It is useful when sending to Ijinus servers.
- **Authentication token:** Enter the authorization token, if required. Will be included in the request body in the Authorization header.

- **Timeout:** Enter an http request timeout in seconds.
- * **Custom headers*:** With the Ijinus format. Enables custom headers.
 - **Key:** Enter the header key to be added.
 - **Value:** Enter its value.

Ijinus format

Format of the request sent via a **POST** for the Ijinus format.

POST_Request		
Header	Authorization	58d97_32fb3
	<Key0>	<Value0>
	<Key1>	<Value1>
	<Key2>	<Value2>
	<Key3>	<Value3>
form-data body	tz	Europe/Paris
	user	ijinusHTTP
	sn	IJA0102-12345678
	crc32	1234ABCDE
	file	data.bin

URL

The url will be in the form: [http|https]://

In the example above the url will be: https://myserver.com/http/upload.

Request header

- **Authorization:** Authentication token, if required.
- **Key0:** Custom header 0.
- **Key1:** Custom header 1.
- **Key2:** Custom header 2.
- **Key3:** Custom header 3.

Body

The body is in form-data format.

- **tz:** Enter the timezone configured in the sensor.
- **user:** Enter the user (as defined [above](#)).
- **sn:** Enter the sensor serial number.
- **filepath:** Enter the file path and its name into the sensor.
- **crc32:** Enter the CRC32 of the file.

-
- **file:** Enter the file in `application/octet-stream..`

Topkapi format

For TOPKAPI communication:

- Enter the server name or IP address and the Authentication Token provided by TOPKAPI.
- For sensor configuration in TOPKAPI, refer to TOPKAPI documentation.

Azure IoT HUB format

For preformatted transmission to Azure IoT Hub.

The uri is preconfigured in the right format: `/devices/ $id/messages/events?api-version=2021-04-12`

Request header:

Header	
Authorization	58d97-32fb3

The body is in the format "

```
{  
  "payload": "base64:sdip<gs5fsd465ggsgs"  
}
```

9.7.7. Data sending in MQTT(s)

Principle

MQTT is a client-server messaging protocol using the publish/subscribe architecture.

At the heart of MQTT are MQTT brokers and clients. The Broker is an intermediary between senders and recipients. Its role is to distribute messages to the appropriate recipients. Clients post messages to the broker and other clients subscribe to specific topics to receive messages.

Each message includes a topic and customers subscribe to topics that interest them. The broker maintains a list of subscriptions and uses it to deliver messages to the relevant clients.

A broker can also buffer messages for disconnected clients, ensuring reliable message delivery even under unreliable network conditions. To enable this, MQTT supports three different Quality of Service (QoS) levels for message delivery: 0 (at most once), 1 (at least once), and 2 (exactly once) (HiveMQ).

Message format

The format of MQTT messages is json (JavaScript Object Notation).

```

Topic: Ijinus/Logger/IJA0102-00001848/DATA/diag  QoS: 0 Retained
{
  "sn": "IJA0102-00001848",
  "tzMinutesOffset": "+120",
  "tzLabel": "CEST",
  "descriptors": [
    {
      "datatype": 6,
      "channel": 0
    },
    {
      "datatype": 6,
      "channel": 1
    },
    {
      "datatype": 3,
      "channel": 7
    },
    {
      "datatype": 17,
      "channel": 0
    }
  ],
  "records": {
    "2025-04-10T11:45:08Z": {"0": 3.45, "1": 3.35, "2": "221", "3": -73}
  }
}
    
```

Activation



The logger must be equipped with a modem board with a SIM card.

- In Avelour, activate **Internet data sending**

- Set a transmission cycle.
- Select the **MQTT** protocol.

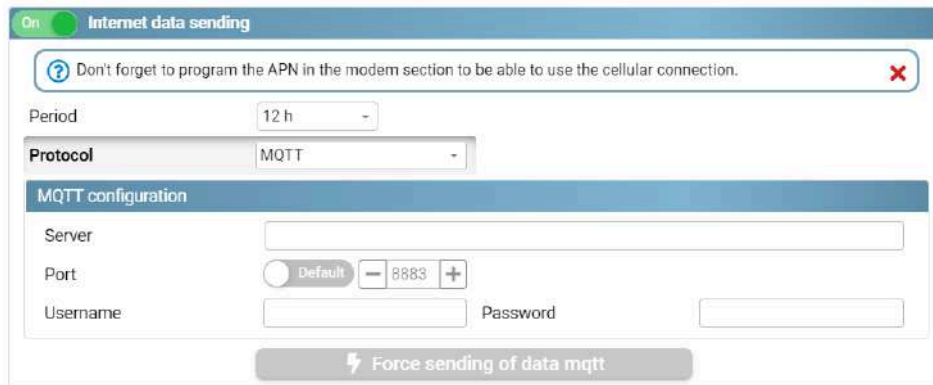

Configuration

- Enter the **Server** identifiers, **Port**, **Username** and **Password**.

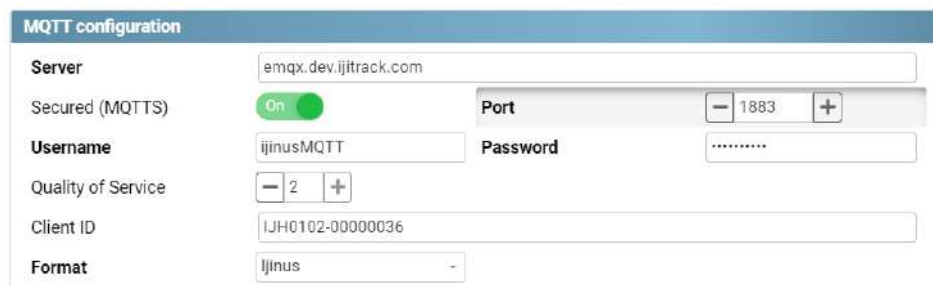

Quality of Service (advanced setting)

The MQTT protocol has a quality of service (or QoS) mechanism, which guarantees the delivery of messages to the client in the event of a failure (e.g., connectivity).

- Click on  to display the advanced setting **Quality of service** and enter a value of 0, 1, or 2.

QoS 0: Lowest quality. The message is only sent once. In the event of a failure, some messages may not be delivered. This quality may be suitable for sending sensor data where occasional data loss would not significantly impact the overall results.

QoS 1: Quality level where messages are confirmed and resent if necessary. This level of quality of service is typically used in situations where message loss is unacceptable, but message duplication is tolerable. This is suitable for sending command messages to devices, where a missed command can lead to serious consequences, but duplicate commands do not.

QoS 2: This level enables "exactly once" delivery, where messages are confirmed and resent until they are received exactly once by the subscriber. Quality of Service level 2 is the highest level of quality of service and is generally used in situations where message loss or duplication is completely unacceptable. With QoS 2, the client and broker use a two-step confirmation process, in which the broker stores the message until it has been received and acknowledged by the subscriber. This level of quality of service is typically used for critical messages such as emergency alerts.

Format Almaviva

In the **Almaviva** format, The option "**Send descriptor**" allows to open a new /DESC channel describing the correspondence between the recorded data tracks and the "Var".

Format Send descriptor

Topic

? For Almaviva format, topic structure will be:

- ljinus/Logger/IJH0102-00000036/HData
- ljinus/Logger/IJH0102-00000036/LOG
- ljinus/Logger/IJH0102-00000036/DESC

Topic Prefix

Topic (advanced setting)

The MQTT messaging model is based on topics and subscriptions. Topics are channels where messages are posted and subscribed to. Topics are hierarchical and can contain multiple levels separated by slashes, like a file path.

- Click on  to display the advanced setting **Topic** and customize the topic format if needed.

Topic

? Topic format will be:

- ljinus/Logger/IJA0102-00000129/DATA/#
- ljinus/Logger/IJA0102-00000129/LOG/#

ClientID GroupID

9.7.8. Advanced internet connection settings

In advanced mode , the following parameters are displayed:

PPP

Attempts to connect Default Timeout to connect Default

SNTP

Sntp server Default

DNS

Alternative DNS server Prioritise the alternative DNS server Off

PPP

PPP : Point to point Protocol -> Internet transmission protocol that enables a connection to be established between two hosts over a point-to-point link.

SNTP

SNTP : Simple network time protocol -> Protocol used to synchronise the clocks of devices on a data network.

- Activate **Snt server** and enter the server address for synchronisation.

Custom DNS server

Alternative DNS server : If necessary, enter the IP address of the custom DNS server to add it to the list contained on the SIM card.

Prioritise the alternative DNS server : Must be enabled to allow priority use of custom DNS.

9.7.9. Certificate management

Generalities

A digital certificate or public key certificate is used primarily to identify and authenticate a natural or legal person, but also to encrypt communications. It can be compared to a digital identity card.

A digital certificate is a data file that associates a publicly known cryptographic key with an organization.

Electronic certificates are verified using a chain of trust. The anchor point of this chain is the *root certification authority*.

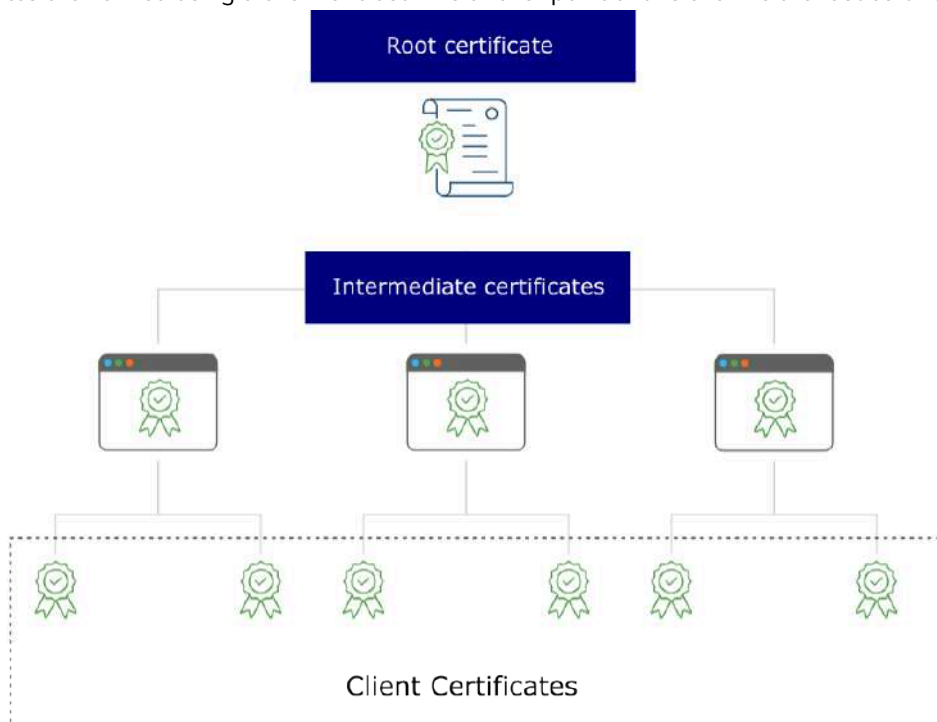

Root certificate

A root certificate, often referred to as a CA certificate, is a digital certificate that serves as the basis for a public key infrastructure (PKI) system. It is issued by a trusted certification authority (CA) and is self-signed, meaning that the CA authenticates itself. Root certificates are stored in a trusted repository known as a root store, which is maintained by browsers and operating systems to authenticate secure connections.

Intermediate certificate

The intermediate certificate serves as a bridge between the root certificate and server certificates, such as TLS certificates for websites. Unlike root certificates, intermediate certificates are not self-signed; they are signed by a root certificate or another intermediate certificate. This structure creates a hierarchy known as a chain of trust.

Managing certificate



The Certificate Management feature button is only visible if the protocol is enabled as secure.

Secured (MQTTS)



 Certificate Management

General

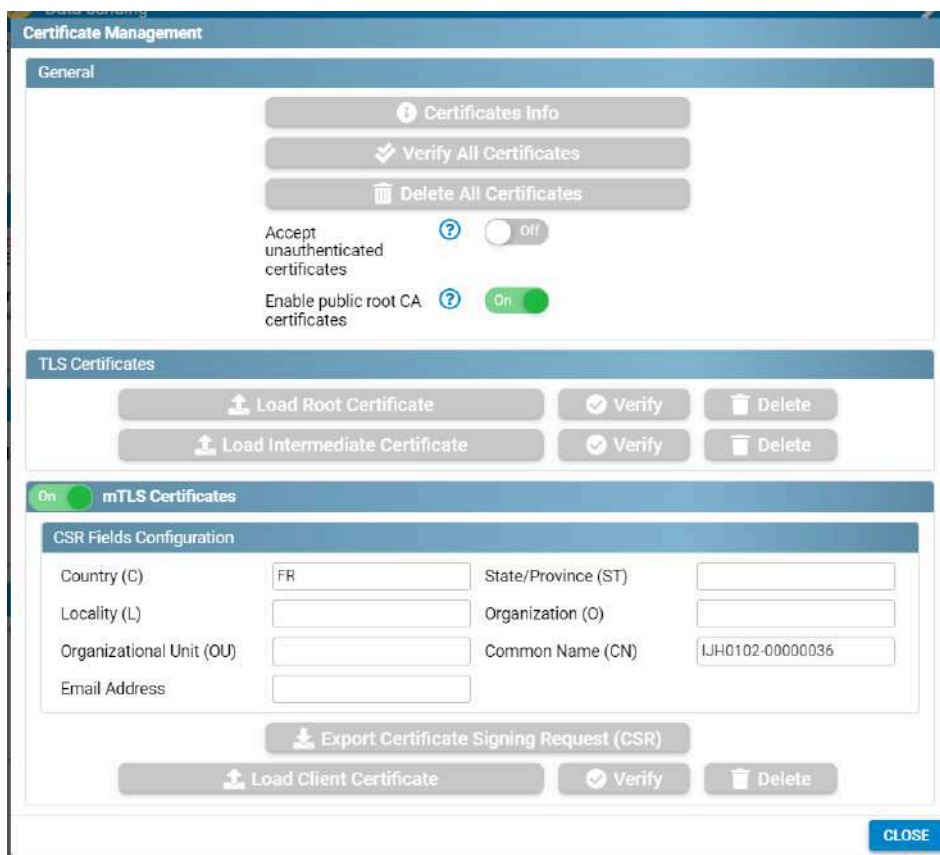

The **Accept unauthenticated certificates** feature, i.e., certificates that are not signed by a trusted certification authority, can be useful in development and testing environments.

The **Enable Public Root CA Certificates** feature allows you to authorize only private or public certificates.

mTLS certificates

Mutual TLS (mTLS) is an authentication method that ensures secure communication between both parties in a connection. Unlike the traditional TLS method, which only verifies the identity of the server, mTLS authenticates both the client and the server by exchanging and validating digital certificates.

mTLS ensures that the parties at each end of a network connection are who they claim to be by verifying that they both possess the correct private key. The information contained in their respective TLS certificates provides additional verification.

1. The client connects to the server
2. The server presents its TLS certificate
3. The client verifies the server certificate
4. The client presents its TLS certificate
5. The server verifies the client's certificate
6. The server grants access
7. The client and server exchange information via an encrypted TLS connection

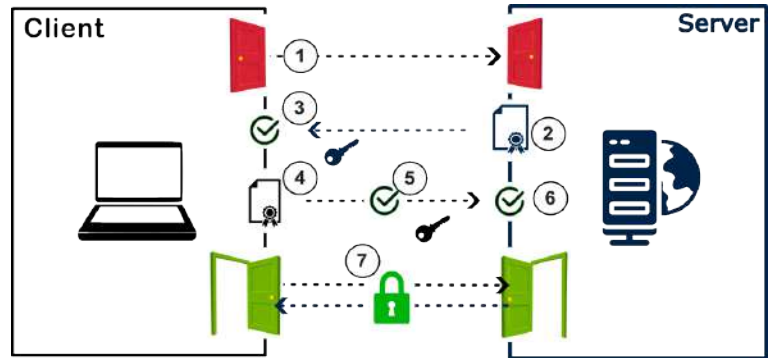

CSR certificate and client certificate

To obtain a client certificate, a certificate signing request (CSR) must be made to a CA in order to obtain a client digital identity certificate.

- Fill in the CSR fields and export the request.
- Upload the client certificate (.pem or .ce)

9.7.10. Data sending via SMS

To configure SMS data transmission:

- Click on "EDIT" in the "Data sending" block.

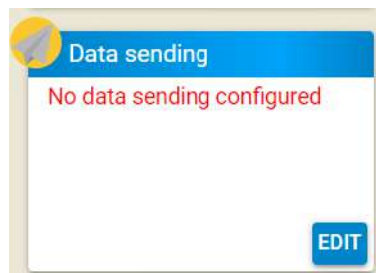

- Activate "SMS data sending".

The **Sending period** corresponds to the frequency at which data are transmitted.

In the example below, transmission occurs every 12 hours:



To check that SMS messages have been sent correctly:

- Enter a phone number in the **Send a test SMS** field indicating the country code (+33 for France).
- Then click on the **Send a test SMS** button and check that the SMS has arrived on the phone identified.

```
IJA0102-00002088  
Ver : 0129/01-1  
Rev : 21.13 (2023/04/03 - Radar)  
2023/11/10 17:04:04  
Rat: 2G GSM-900  
Oper : Orange  
Rssi : -49 dBm (ext)
```

Example of an SMS received on the recipient's phone

- Enter the **server phone** number to transmit the data.

The **SMS Site ID** is a value that identifies the logger on the server and the supervision system used to display the data.

- If data are sent to the Ijitrack web service, no modification is required.
- If data are sent to another supervision system, contact the person in charge of supervision to define the correct SMS Site ID.

9.7.11. Data sending in LoRaWAN



The configuration of data transmission in LoRaWAN is available from version 7.1.2 of the Avelour software.

A logger equipped with an built-in modem has a unique identifier (DevUID). This identifier is required to configure your LoRaWAN server (LNS: Lora Network Server).

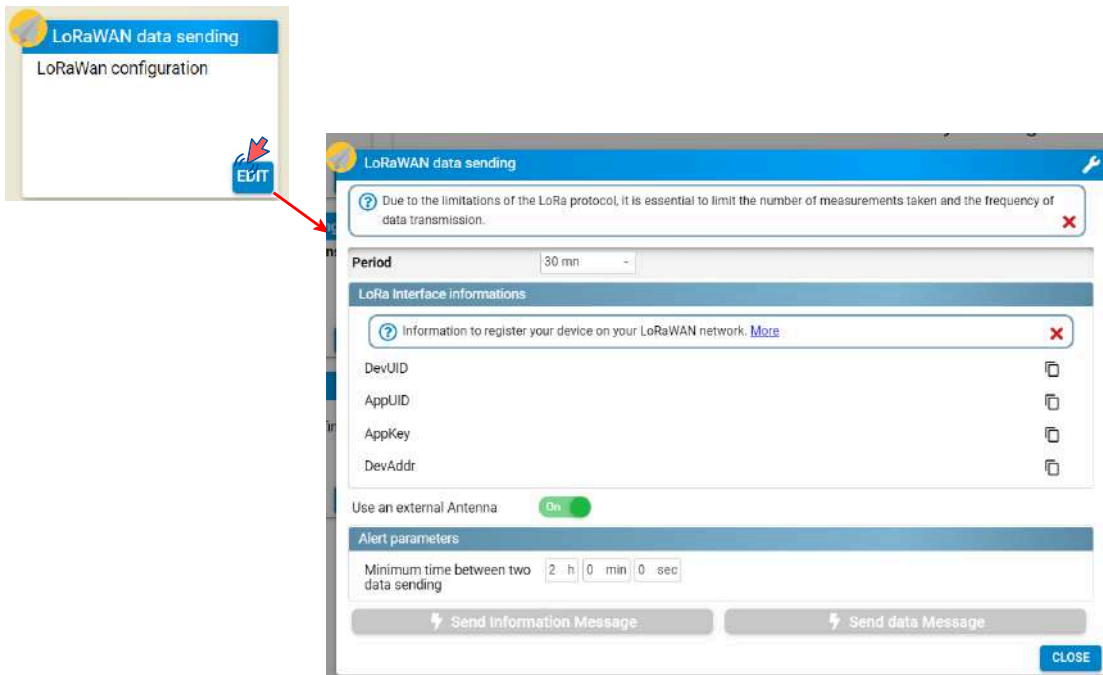

Transmission cycle

- Select the frequency of the data transmission cycle on the LoRaWAN server.

Login information

DevEUI: Identity of the end device (64 bits).

AppEUI: Identity of the application (makes the owner of the end device unique).

AppKey: Key used by the server and the end device to encrypt and decrypt packet data.

DevAddr: Identity of the end device (32 bits).

Test data transmission

- Click “Send information message” to send a message containing diagnostic information
- Click “Send data message” to send a message containing measurement data.

Advanced settings

Downlink Waiting Time 	<input type="text" value="1000"/> ms <input type="button" value="+"/>	Timeout 	<input type="text" value="10000"/> ms <input type="button" value="+"/>
Request for acknowledgment 	<input type="checkbox"/> Off	Multiple send 	<input type="text" value="1"/> <input type="button" value="+"/>

Downlink waiting time

Waiting time between the end of message transmission and the start of the LNS downlink frame listening phase (for TTN: 5000 ms)

Timeout

Maximum network connection time (ms).

Request for acknowledgement

For all transmissions, activate the request for acknowledgement from the LNS.



Depending on the platform, this may be a paid option.

Multiple send

If there is no acknowledgement, data can be sent multiple times to increase the reception rate.

Expert mode

Reset period

Modem reset periods to ensure that the modem is working. Forces the modem to disconnect from and reconnect to the network.

Use an external antenna

On: External antenna

Off: Internal antenna

Integration of a logger on Orange Live objects

- Select the "Generic_classA_RX2SF12" profile.
- Copy and paste the identifier (DevEUI) and the keys (AppKey and AppEUI) from the data provided in Avelour.

Interface - LoRa

DevEUI *

Profil *

Options de connectivité Macro-géolocalisation LoRa

Plan de connectivité *

AppEUI *

AppKey *

Integration of a logger on WIOTYS

- Select the “LorawanPrivate” protocol
- Copy and paste the identifier (DevEUI) and the keys (AppKey and AppEUI) from the data provided in Avelour.

PARAMÈTRES

DevEUI *

App Key *

AppEUI *

Type d'activation

Classe

Integration of a logger on THE THINGS

- Select “Enter end device specifics manually”
- Fill in the Frequency plan, LoRaWAN version and Regional Parameters fields as shown below:

Register end device

Does your end device have a LoRaWAN® Device Identification QR Code? Scan it to speed up onboarding.

Scan end device QR code Device registration [help](#)

End device type

Input method

- Select the end device in the LoRaWAN Device Repository
- Enter end device specifics manually

Frequency plan

Europe 863-870 MHz (SF12 for RX2)

LoRaWAN version

LoRaWAN Specification 1.0.2

Regional Parameters version

RP001 Regional Parameters 1.0.2

Show advanced activation, LoRaWAN class and cluster settings

Provisioning information

JoinEUI

..... Confirm

To continue, please enter the JoinEUI of the end device so we can determine onboarding options

- Copy and paste the identifier (DevEUI) and the keys (AppKey (= JoinEUI) and AppEUI) from the data provided in Avelour.

Provisioning information

JoinEUI = AppEUI (Avelour)

70 B3 D5 32 60 00 01 00 Reset

This end device can be registered on the network

DevEUI

70 B3 D5 32 60 07 29 D8 Generate 0/50 used

AppKey

AA 4E 6C 37 85 E3 3A 5E F8 45 31 30 8D CE E8 AC Generate

End device ID

eui-70b3d532600729d8

This value is automatically prefilled using the DevEUI

9.7.12. Configure an alarm

To avoid draining the internal battery too quickly in the event of a programming error, a safety feature can be configured: "alarm parameter ". By default, this parameter imposes a minimum duration of 2 hours between two transmissions related to an alert.

- In the "data sending" window,



- Enter a minimum time between two transmissions.

9.7.13. Sending an alert SMS



The server phone number needs to be configured.

The SIM card must allow sending of SMS text messages.

Sending an alert SMS only works if a threshold is exceeded and Anticipate data sending is active.

- Enter a phone number in the "Send alert SMS" window.

-> A second input field appears, allowing you to add another operator and each time a field is filled another field appears.



It is possible to add up to a maximum of 9 phone numbers.





If data is sent using FTP, approximately 3 minutes elapses between the time that the threshold is exceeded and the message is received.

9.8. Test data transmission before commissioning

9.8.1. Objective

Before commissioning an Ijinus datalogger equipped with a communication PCB, you must ensure it operates correctly in the field with the selected communication networks.

9.8.2. Test procedure



1. In the data transmission menu, click on the edit button, when the popup opens click on the wrench  in the top right to display the advanced settings.
2. Configure the modem part as shown below:



The screenshot shows a configuration form with the following fields and values:

- Technology to use:** LTE-M
- Region:** World
- Priority operator:** Active (with a code of 10000)
- PIN code:** Active
- APN:** lot.1nce.net
- PPP phone:** Inactive
- PPP user:** Inactive

- Select “LTEM” technology only.
- Set the location to **world**.
- Enter the **APN** linked to your SIM card.
- Activate the priority operator: the space to enter the code is now available (you will need to know the operator code beforehand — see the list of operators in the country).

3. Program the modem. 
4. Run modem diagnostics .
5. Activate  data sending by Internet with the desired transmission cycle.
6. Start a data transmission test.

9.8.3. Troubleshooting

Network connection issues can occur at key stages of the test:

Problem	Step	Corrective action
Failed to connect to the network	4	<ul style="list-style-type: none"> • Change the priority operator and redo from step 3 on existing networks

		<ul style="list-style-type: none"> • Increase timeout from 120 s to 180 s (see image below) 
Failed to connect to SNTP server	6	<ul style="list-style-type: none"> • Check the APN code • Change the priority operator and try again
Connected to the SNTP server but failed to connect to the FTP	6	<ul style="list-style-type: none"> • Check the FTP server identifiers

9.9. Sending logger configuration using server (remote configuration)

9.9.1. Principle

To modify the settings of a logger without being connected via radio link (wiji), you need to have specific access to the Ijitrack server.

Remote configuration cannot be performed via SMS. Only the **Internet data sending** option allows you to send data and receive a new configuration file.

In fact, data is no longer sent to the root of the Ijitrack server but to a specific space protected by a username and password that are different from those used for Ijitrack.

These server access settings must be entered into the Avelour software when configuring the radio link recorder.

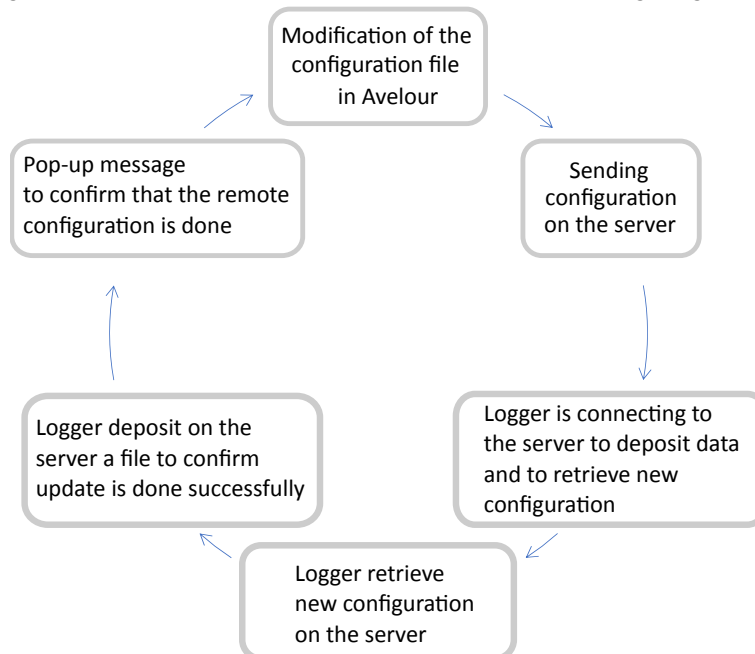

9.9.2. Configuring server access on Avelour

FTP



Contact customer service to unlock the feature that allows you to customize specific access other than Ijitrack.

- In the **Options** menu, click on **Configuration** and go to the **Remote Config** tab.
- Enter the broker name, the username and the password.
- When it's done, click on "Test MQTT" button to check that the connection between Avelour and the MQTT Broker is available.
- If yes, it's possible to modify a setting or a Firmware remotely.
- If not, a modification must be done on written data.

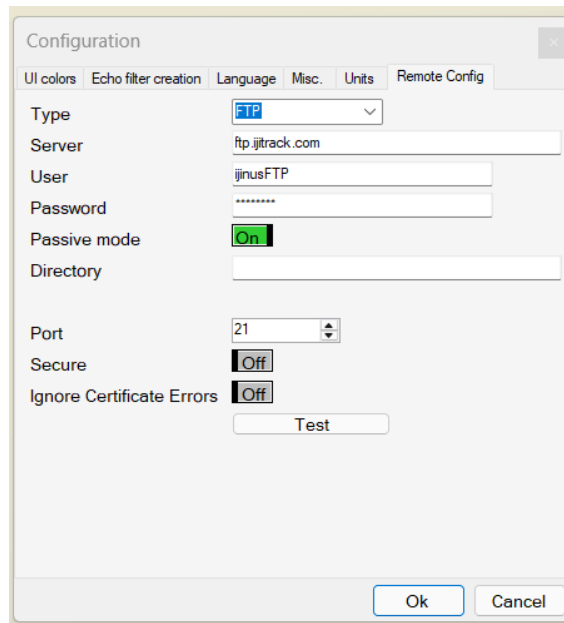

Configuration

UI colors Echo filter creation Language Misc. Units Remote Config

Type

Server

User

Password

Passive mode On

Directory

Port

Secure Off

Ignore Certificate Errors Off

HTTP



Contact customer service to unlock the feature that allows you to customize specific access other than Ijitrack.

- In the **Options** menu, click on **Configuration** and go to the **Remote Config** tab.
- Enter the access parameters (Server, user, API key, port) exactly as they were entered in the data transmission configuration.
- When it's done, click on "Test HTTP" button to check that the connection between Avelour and the MQTT Broker is available.
- If mTLS is enabled, refer to the paragraph [Certificate management](#).

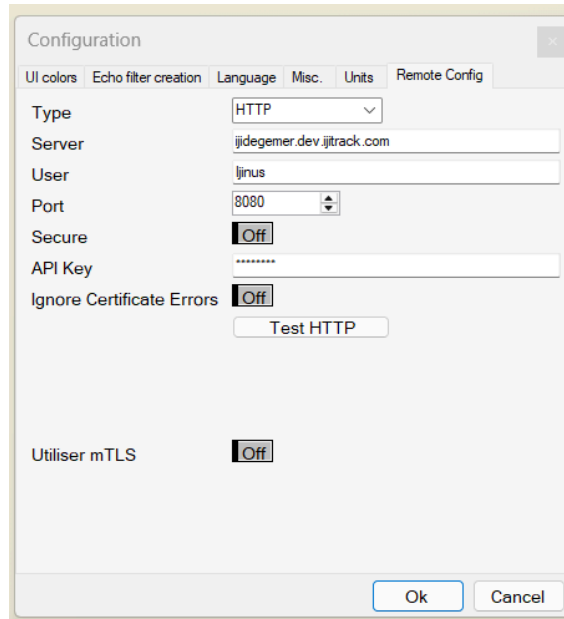

Configuration

UI colors Echo filter creation Language Misc. Units Remote Config

Type HTTP

Server ijidegemer.dev.ijitrack.com

User ljinus

Port 8080

Secure Off

API Key

Ignore Certificate Errors Off

Test HTTP

Utiliser mTLS Off

Ok Cancel

MQTT



Contact customer service to unlock the feature that allows you to customize specific access other than Ijitrack.

- In the **Options** menu, click on **Configuration** and go to the **Remote Config** tab.
- Enter the access parameters (Server, user, API key, port) exactly as they were entered in the data transmission configuration.
- When it's done, click on "Test MQTT" button to check that the connection between Avelour and the MQTT Broker is available.
- If mTLS is enabled, refer to the paragraph [Certificate management](#).

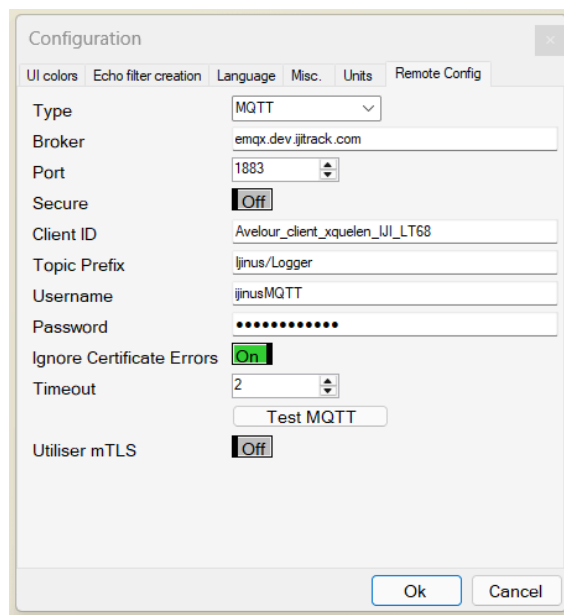

Configuration

UI colors Echo filter creation Language Misc. Units Remote Config

Type MQTT

Broker emqx.dev.ijitrack.com

Port 1883

Secure Off

Client ID Avelour_client_xquelen_UJ_LT68

Topic Prefix ljinus/Logger

Username ljinusMQTT

Password

Ignore Certificate Errors On

Timeout 2

Test MQTT

Utiliser mTLS Off

Ok Cancel

9.9.3. Configuring data sending

The use of an FTP server is required to perform remote configuration or firmware updates with internet data sending via FTP, Coap, HTTPS or MQTT.



It is necessary to configure remote FTP in the Avelour options.

If you are using another server, contact Ijinus to obtain a version of Avelour that allows you to customize the server configuration.

- Activate **Internet data sending** and choose [FTP](#), [HTTP](#) ou [MQTT](#) protocol.

FTP

- Enter the access name in the **FTP Server** line by switching the **Default** button to **define**, and enter the access name (TEST in the example below).
- The password is managed automatically by Avelour, but you can enter it in the FTP Password line by switching the **“default”** button to **“define”** and then entering the password.
- The other settings for sending data must not be changed.

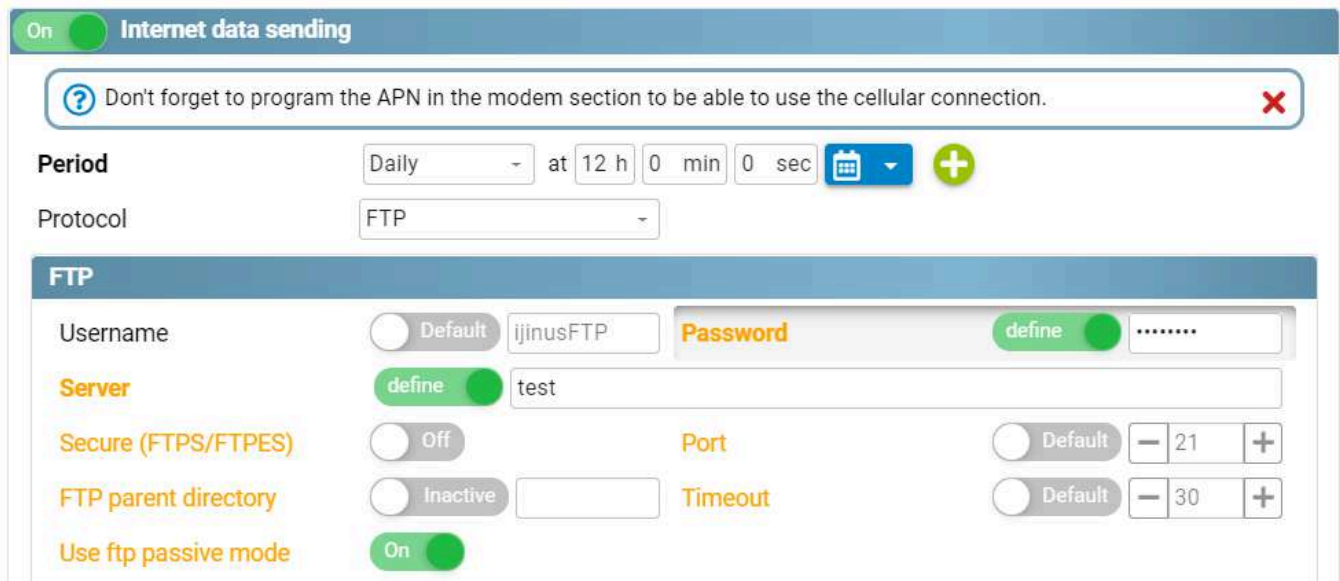

FTP configuration server with FTP protocole

HTTP

- Enter the same settings as those entered in the server access configuration. (???)



Authorization token correspond to API KEY

HTTP

Request format ?

Server ?

Secured (HTTPS) ? **Port** ?

Username ?

Authorization Token ?

MQTT

- Enter the same settings as those entered in the server access configuration. (???)

MQTT configuration

Server

Secured (MQTTS) **Port**

Username **Password**

Quality of Service

Client ID

Format

Topic

? Topic format will be:

- ljinus/Logger/IJA0102-00000016/DATA/#
- ljinus/Logger/IJA0102-00000016/LOG/#

✘

Topic Prefix

When choosing the **Almaviva** format, it is possible to enable **Send descriptor**, allowing the addition of a topic (/DESC), describing the correspondence between the recorded data channels and the "Var".

Format **Send descriptor**

Topic

? For Almaviva format, topic structure will be:

- ljinus/Logger/IJA0102-00000016/HData
- ljinus/Logger/IJA0102-00000016/LOG
- ljinus/Logger/IJA0102-00000016/DESC

✘

Topic Prefix

9.9.4. Retrieving a configuration via internet

To modify a settings remotely :

- Go in "Actions" menu and click on "Configure a device remotely"

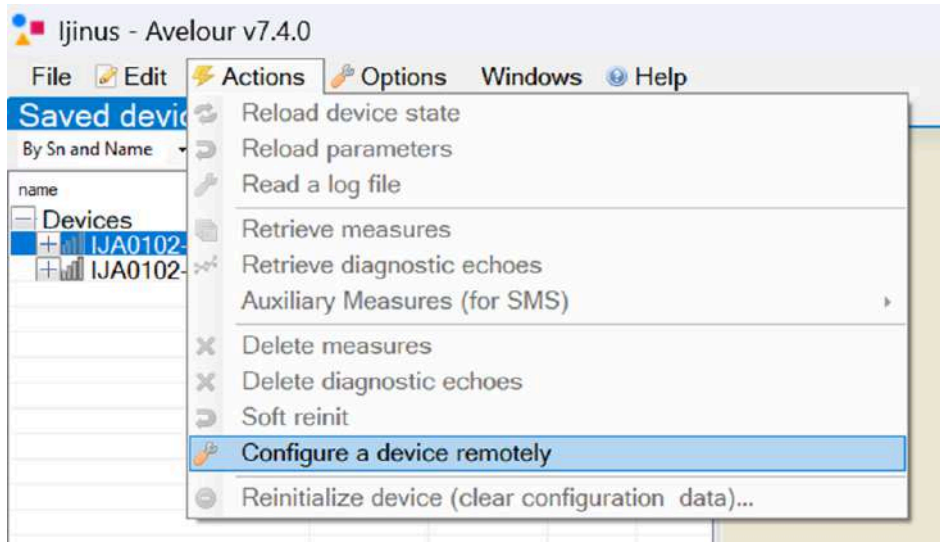

- Enter the serial number of the logger you want to modify remotely :

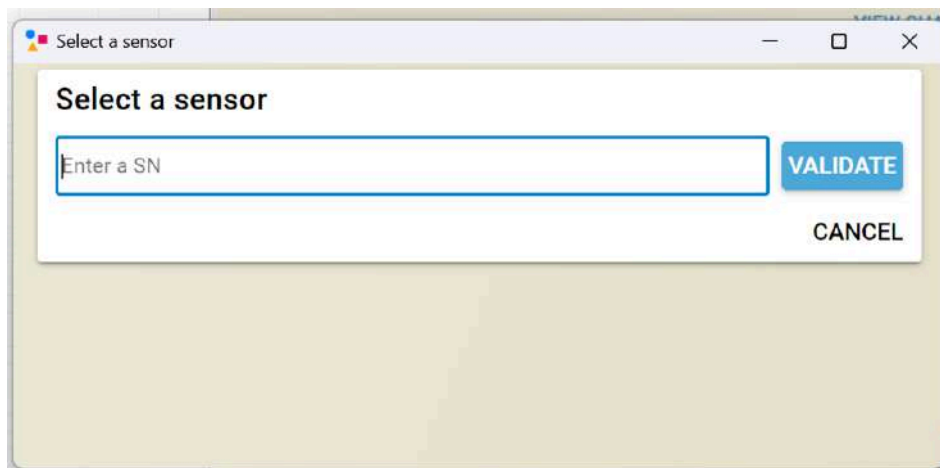

- In this page you can download data (1 week history), echo files, log, or the latest configuration on the broker.
- Click on download latest configuration to be able to modify the configuration.

 DOWNLOAD LATEST CONFIGURATION

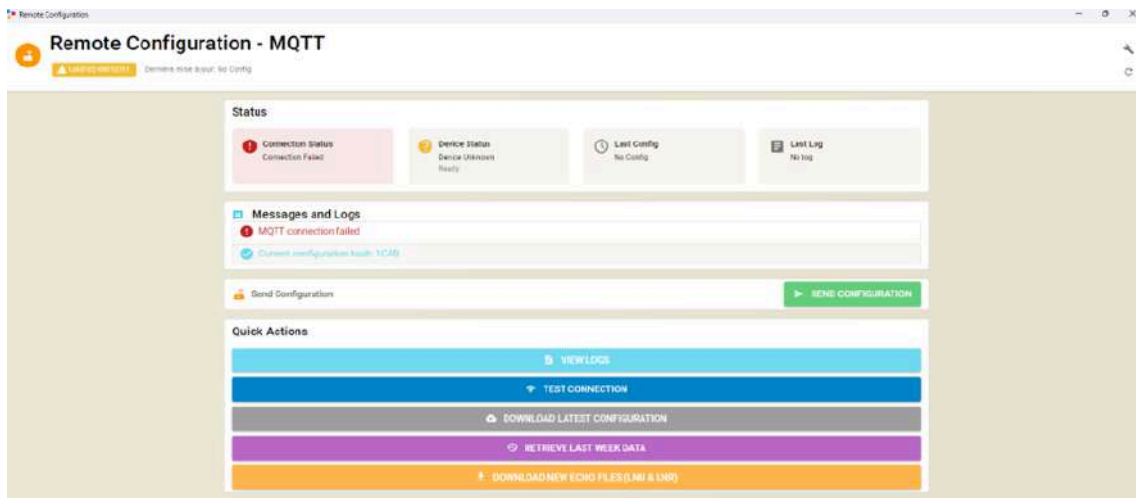

9.9.5. Edit and send the configuration remotely

In the saved data window:

- Open the configuration file for the relevant recorder :
 - Right-click on the configuration file and click on “Show.”
- or
- Double-click on the file.

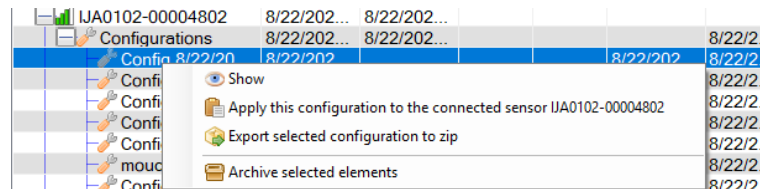

- Click on edit to exit the read only mode and modify the configuration.



- Once modified, click on one of the option : **SAVE CONFIGURATION OR SEND TO FTP** or **SAVE CONFIGURATION OR SEND TO MQTT SERVER** OR **SAVE CONFIGURATION OR SEND TO HTTP SERVER**.



- Enter a name to identify the new configuration that will appear in the saved data.
- Click on Save and send to remote server to upload the new configuration to the server.

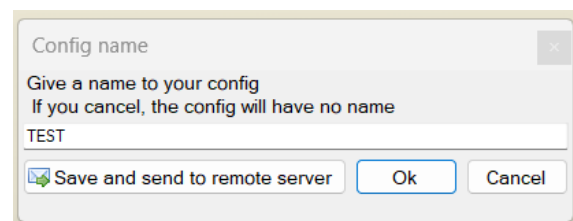

-> The remote configuration window opens, and Avelour connects to the server to verify that the logger has already deposited data on the server.

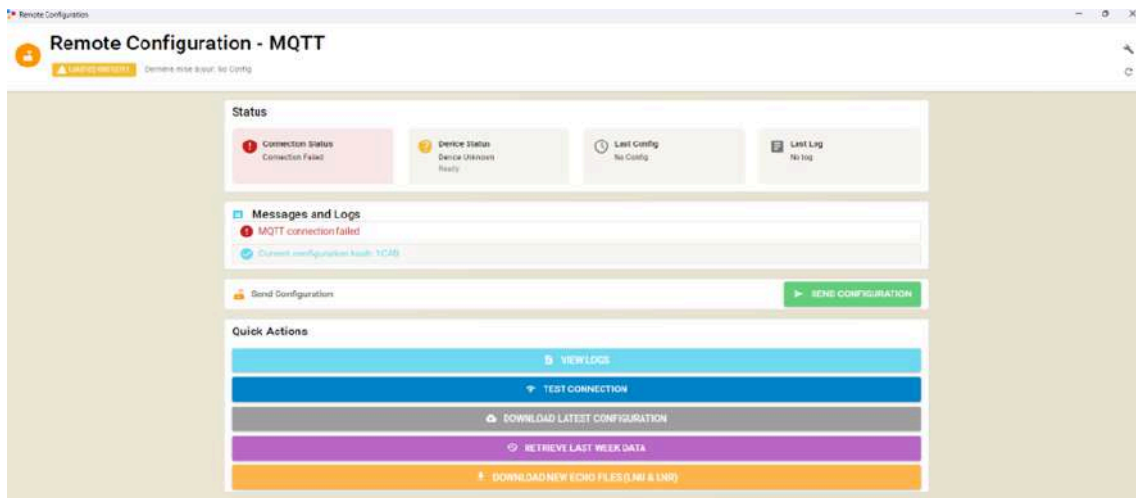

- Check the status and click on “Send configuration”.



Beware ! remote firmware status update and remote configuration can't be done simultaneously. Take care to launch one when the other is finished.



- The next time the recorder connects to the server to deposit data, it will download the file containing the modified configuration.
- A check is performed after the update to ensure that the change has been taken into account.

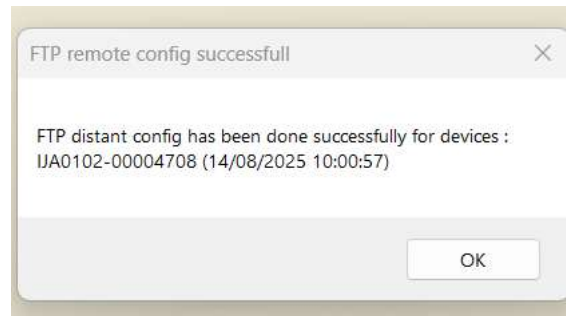

Update pop-up window

9.9.6. Do a remote configuration of a logger without a communication card

If the sensor whose configuration you want to modify does not have a communication card, you must specify the recorder to which it is paired (called the parent device) so that the configuration is first downloaded by the recorder and then sent via the radio link to the target sensor.

If the recorder, whose configuration you want to modify remotely, does not have a communication card, you must configure a recorder with a communication card (Master) to which the recorder will be paired. The configuration will first be downloaded by the master recorder and then sent via the radio link to the slave recorder.

- Edit the **Retrieve Device** feature in the master recorder configuration (with communication card and set up for sending data) by adding the slave recorder (without card). (See paragraph ???).

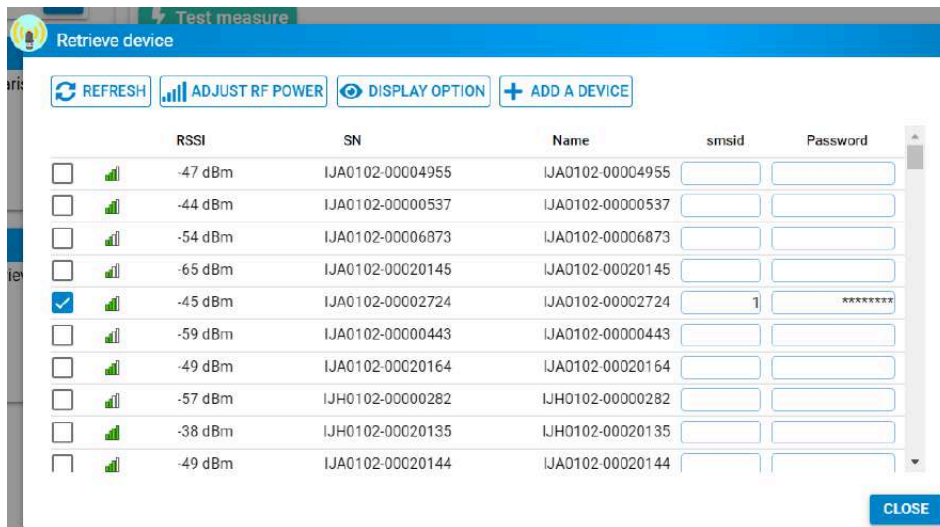

- Save the new configuration.

In the saved data window:

- Open the configuration file for the relevant recorder (without communication card):
 - Right-click on the configuration file and click on "Show."
- or
- Double-click on the file.

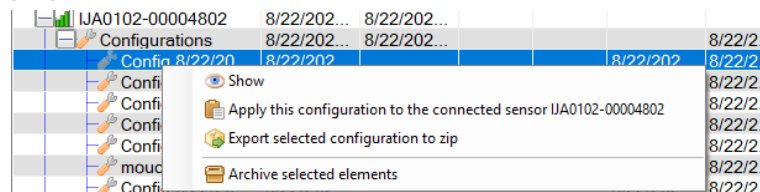

- Click on **EDIT** to exit the read only mode and modify the configuration.



- Once modified, click on one of the option : **SAVE CONFIGURATION OR SEND TO FTP** or **SAVE CONFIGURATION OR SEND TO MQTT SERVER** OR **SAVE CONFIGURATION OR SEND TO HTTP SERVER**.



- The next time the recorder connects to the server to deposit data, it will download the file containing the modified configuration.
- A check is performed after the update to ensure that the change has been taken into account, and a message is displayed on Avelour when data is sent for the first time.

9.10. Power supply configuration

The power supply is managed in the "System options" window.

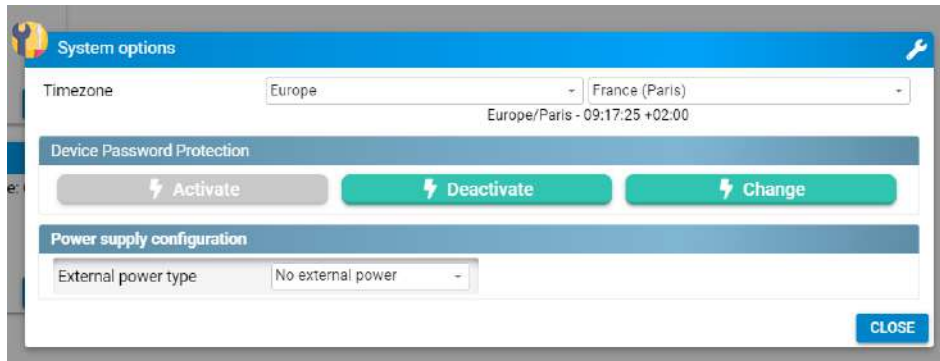

9.10.1. Lithium battery

The logger retrieves the voltage from the external power supply and stops measurements if a minimum voltage threshold is reached. This threshold depends on the type of external power supply and the rated voltage

Examples of thresholds:

- 10.8 V Lithium battery pack: $10.8 \times 0.8 = 8.6$ V.

To configure a 14.4-volt battery pack:

- In expert mode and advanced settings , change the rated voltage from 10.8 to 14.4 V. The threshold for stopping measurements will be $14.4 \times 0.8 = 11.5$ V.

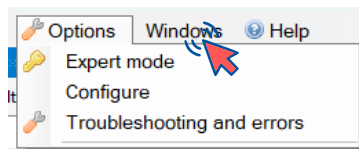

Connector power supply: Select whether the probe is powered directly from the external battery or from the logger's internal power supply, in which case the **voltage applied to the output** can be set between 5 and 18 Volts.

Record external power supply voltage: Enables remote monitoring of pack charge.



You must connect to the logger so that it can take measurements with the external sensor connected.

9.10.2. Lead-acid battery

The logger collects the voltage data from the external power supply and stops measurements if a minimum voltage threshold is reached. This threshold depends on the type of external power supply and the rated voltage.

Examples of thresholds:

- 12 V lead-acid battery: $12 \times 0.875 = 10.5 \text{ V}$.



For a lead-acid battery and if the logger has been configured with a lead-acid battery, you do not need to connect to the logger via Avelour.

To configure a 12-volt battery pack:

- In expert mode and advanced settings  change the nominal voltage to 10.5 V

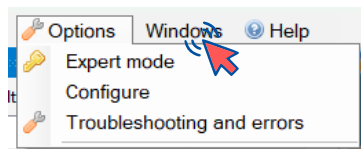

- Reconnect a recharged battery and the logger will resume its operating cycle.

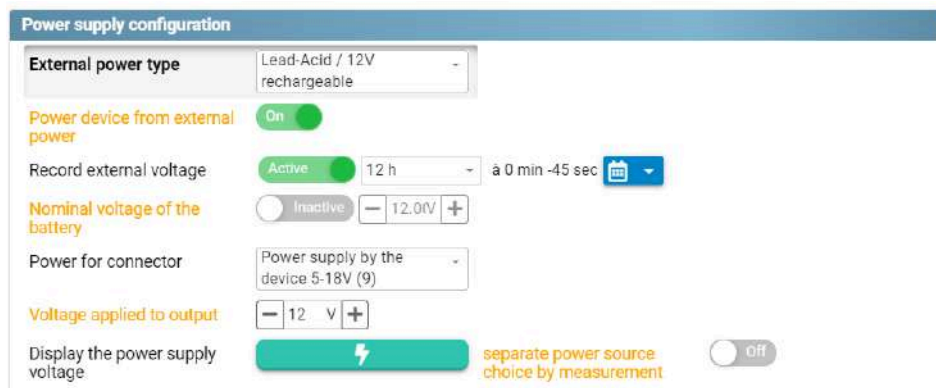

Connector power supply: Select whether the probe is powered directly from the external battery or from the logger's internal power supply, in which case the **voltage applied to the output** can be set between 5 and 18 Volts.

Record external power supply voltage: Enables remote monitoring of pack charge.

9.11. Set time zone

In the "System Options" window:

- Click on the drop-down menu to select the desired time zone (Europe in the example below).
- Select the city corresponding to the desired time zone.

-> The time that will be applied to the logger is then recalculated automatically.

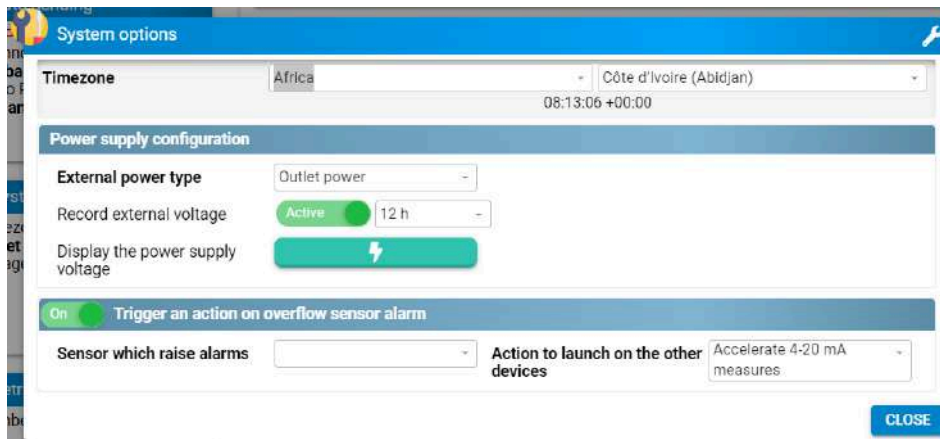

9.12. Pairing one or more loggers

In addition to its measurement capability, a logger can also be used as a hub (or master logger). In fact, it can retrieve data from another logger wirelessly and by radio, if they are less than 25 m apart in an unobstructed open field, or if one is in a manhole, under a metal cover and the other is not (in this case, the distance between the two hubs must be less than 5 m). The "master" logger then retrieves data from a "slave" logger. This option is called pairing and is configured in the "master" logger. No settings are required on the slave logger.

In the "Retrieve devices" block:

- Click "EDIT".

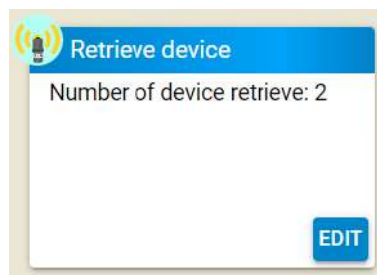

- Select one or more loggers from the list.

-> the software generates an **smsid** to identify data from each paired logger when sent by SMS.



The channel number used by some supervisors to associate equipment data is 0 by default (i.e. cannot be modified via software) for a "master" logger. The channel numbers of paired loggers are set by the "sms id" (here, for example, 1). Each paired sensor will therefore have a different sms id.

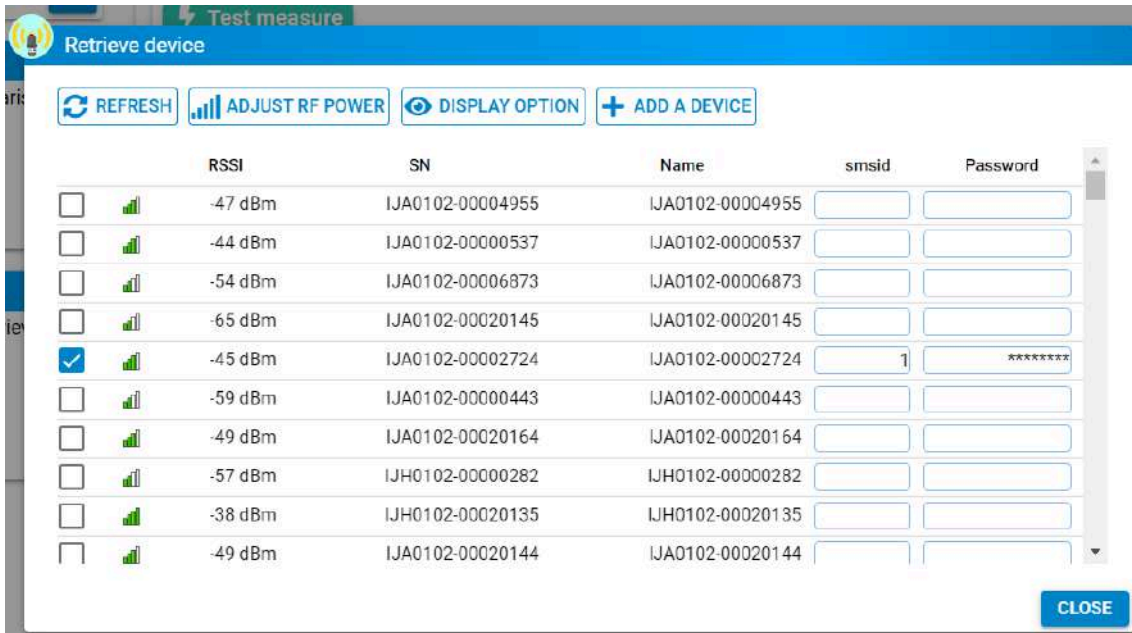

- If the sensor you are looking for is not available, click the "refresh" button to update the page.

9.13. Check the status of data recording and transmission

In the configuration window, two icons allow you to control the status of data recording and transmission.

A : Current status

B : Status after loading the configuration on the logger, useful information to check if the configuration being edited is correctly configured.

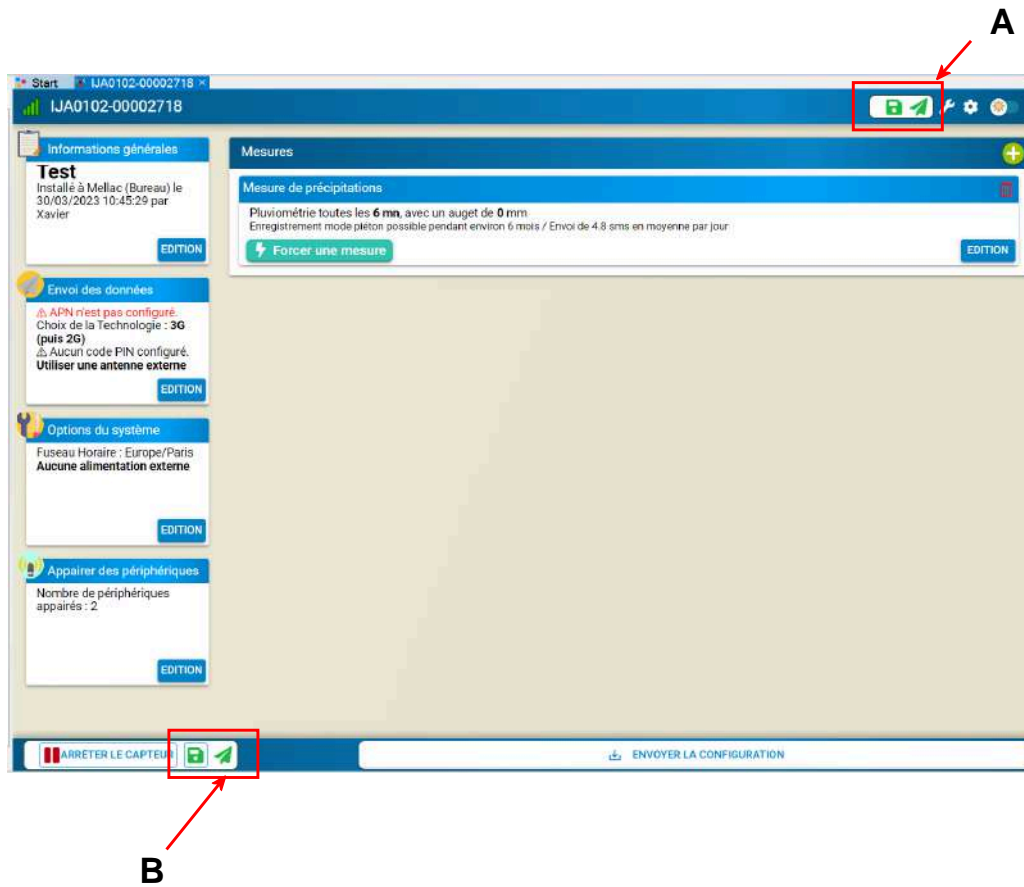

No data are being recorded



No data are being transmitted



Data are being recorded



Data are being transmitted

9.14. Save the configuration to the logger



Prerequisites: The logger is connected to Avelour (see [Connecting to a logger](#)).

To save all the settings configured on the logger:

- Click "SEND CONFIGURATION".

 **SAVE CONFIGURATION**

-> An update loading window is displayed.



-> Recording and data transmission are stopped. 

- To restart the measurement, click on restart.



9.17. Disconnect from the logger



Disconnection from the logger occurs automatically after a few minutes when no data is transferred.

To force disconnection from a logger in Avelour:

- Click the cross to close the configuration window.

9.18. Managing a configuration

9.18.1. View a configuration file



it is possible to view a configuration file offline.

In the saved data window:

- Double-click the configuration file to display it in the main window.

Item	Start Date	End Date
IWA0102-00004708 (Test)	01/01/2020 ...	15/01/2025 ...
Configurations	21/11/2024 ...	15/01/2025 ...
Config 15/01/2025 1...	15/01/2025 ...	
Config 15/01/2025 0...	15/01/2025 ...	
Config 15/01/2025 0...	15/01/2025 ...	
Test 1	15/01/2025 ...	
Config 14/01/2025 1...	14/01/2025 ...	
Config 14/01/2025 1...	14/01/2025 ...	
Config 14/01/2025 1...	14/01/2025 ...	
Config 14/01/2025 1...	14/01/2025 ...	
Older	21/11/2024 ...	14/01/2025 ...
Data	01/01/2020 ...	27/11/2024 ...
Files	01/01/2020 ...	27/11/2024 ...

9.18.2. Archive a file

Archiving allows you to manage how files are displayed in the saved data window.

In the Saved data window:

- Right-click on the configuration file to archive and click "Archive selected elements".

-> The configuration file is no longer visible and a folder containing the archived files, named "_archive_" is created in the logger directory.

Example: C:\ProgramData\Ijinus\Avelour_Main_7.1.2\SavedSensors\IJA0102-00004708_archive_

- To view the archived configuration file, click "Filter elements" and click "View Archived elements"

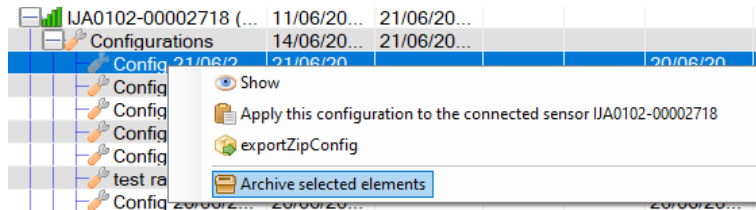

-> The configuration file appears crossed out.

- To retrieve it from the archive, right-click and click "Unarchive selected elements"

9.18.3. Create a configuration template

- Connect to a logger and open an existing configuration via the Saved data window.
- In the "Edit" menu, select "Save device configuration as template".

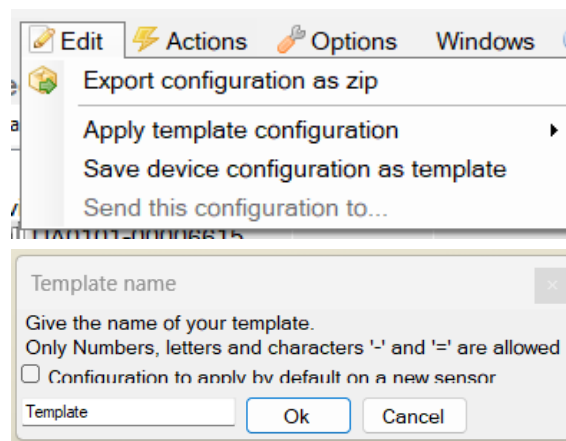

- Check the "Configuration to apply by default on a new sensor" option so that the template is applied automatically when connecting a new logger.
- Enter a name and click "OK".

-> An .IJCZ file is created in the following directory: C:\ProgramData\Ijinus\Avelou_Main_7.xxxxx\userTemplates.

-> The new template is available in the "Edit" menu.

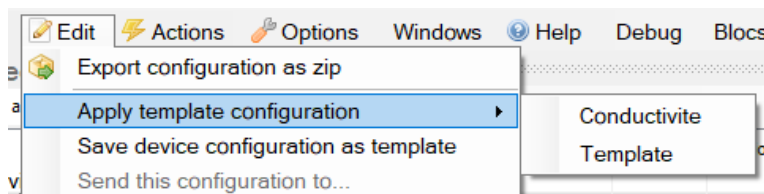

9.18.4. Apply a configuration template



A configuration template must be created. See [Create a configuration template](#).

- Connect to the logger that you wish to apply a template to (see [Connecting to a logger](#)).
- In the "Edit" menu, click on the template to apply.

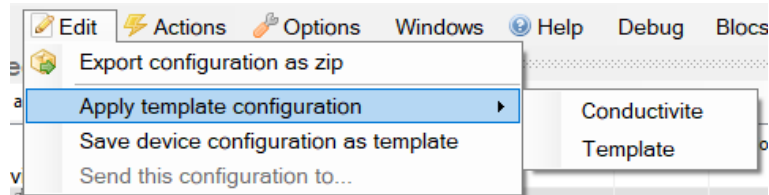

Chapter 10. Data management on Avelour

10.1. Retrieving saved data

To retrieve saved data:

- Connect to the logger (see paragraph [Connecting to a logger](#)).
- Click "Retrieve without deleting" to keep the data in memory in the logger or "Retrieve and delete" to empty the recorder memory.

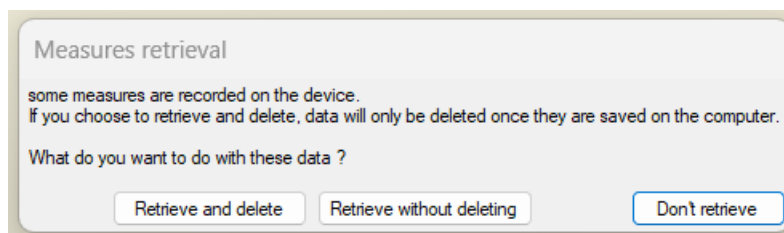

Or

- In the "Actions" menu, click on retrieve measures.

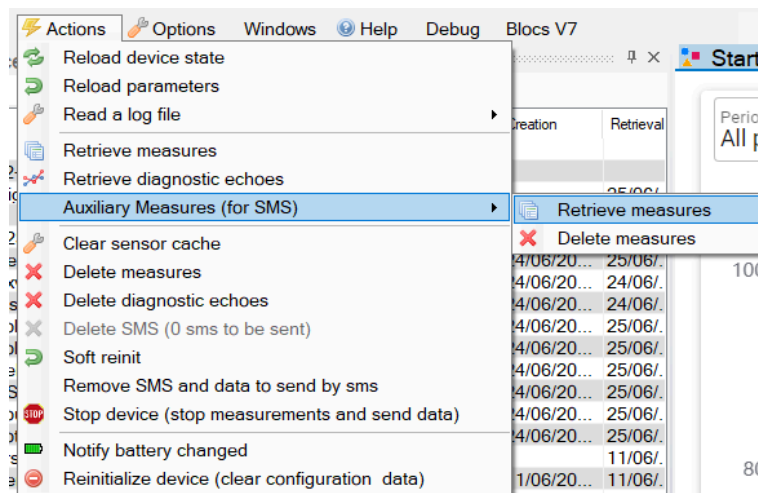

-> The saved data display window opens.

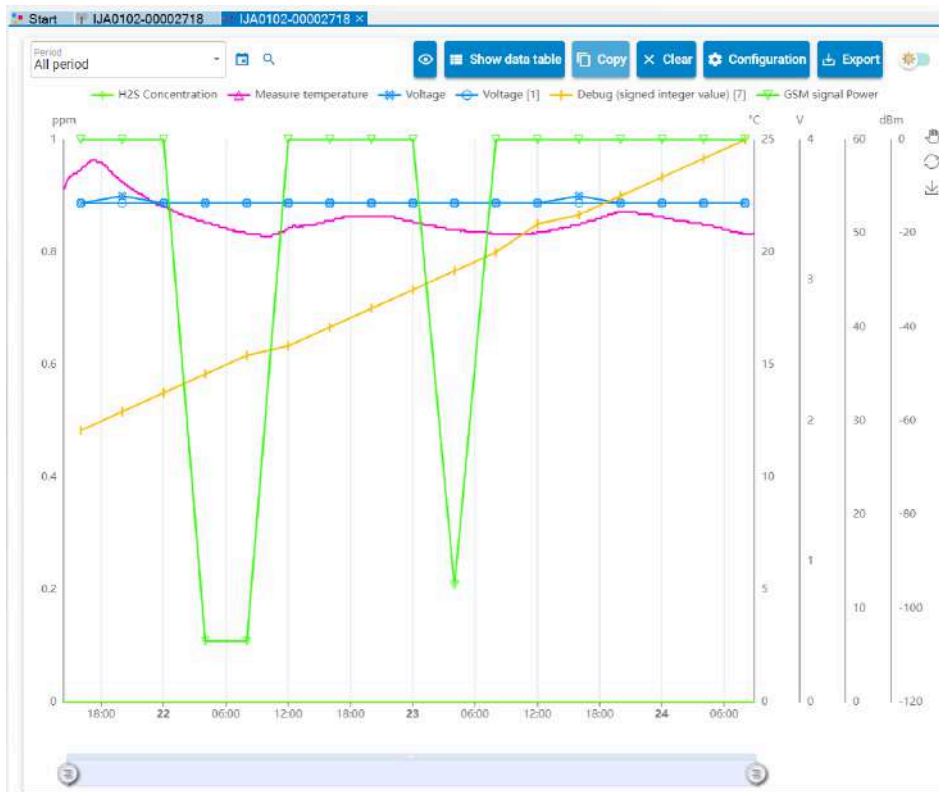

-> In the saved data window, the data appears in the browser structure.

Saved devices

By Sn and Name Device filter

name	First	Last	Data ty...	Records	Creation	Retrieval
Devices						
[-] IJA0102-00002718 (...)	11/06/20...	24/06/20...				
[-] Configurations	24/06/20...	24/06/20...				24/06/...
[-] Data	24/06/20...	24/06/20...				24/06/...
[-] H2S Concentra...	24/06/20...	24/06/20...	0038[...]	40	24/06/20...	24/06/...
[-] Measure temp...	24/06/20...	24/06/20...	0012[...]	40	24/06/20...	24/06/...
[-] Oxygen saturat...	24/06/20...	24/06/20...	0028[...]	39	24/06/20...	24/06/...
[-] Dissolved oxyq...	24/06/20...	24/06/20...	0029[...]	39	24/06/20...	24/06/...
[-] Voltage	24/06/20...	24/06/20...	0006[...]	1	24/06/20...	24/06/...
[-] Voltage [1]	24/06/20...	24/06/20...	0006[...]	1	24/06/20...	24/06/...
[-] Debug (signed...	24/06/20...	24/06/20...	0003[...]	1	24/06/20...	24/06/...
[-] GSM signal Po...	24/06/20...	24/06/20...	0017[...]	1	24/06/20...	24/06/...
[-] Filter	11/06/20...	11/06/20...				11/06/...

10.2. Retrieve data from auxiliary memory



The data transmitted in SMS text messages are stored in the auxiliary memory of the device.

Data transmitted via FTP are stored in the main memory.

To retrieve data locally with a logger configured to send data in M2M:

- In the main Actions menu, click on Auxiliary measures (for SMS) > Retrieve measures.

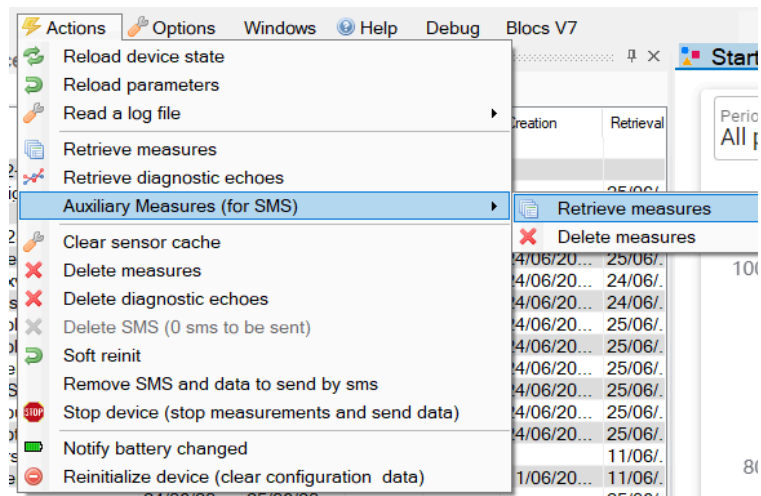

-> In the saved data window, the data retrieved appears in the browser structure.

10.3. Create a new calculated value

From the data retrieved in Avelour, it is possible to create new data values by applying a filter.

- In the saved data window, right-click on the base data for the new calculation.

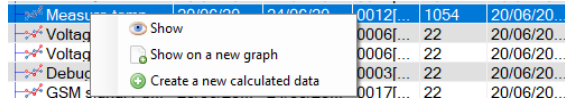

- In the Edit window, select a **filter type** among the four available:
 - Statistical filter
 - Time offset
 - Apply a conversion table
 - Drift correction

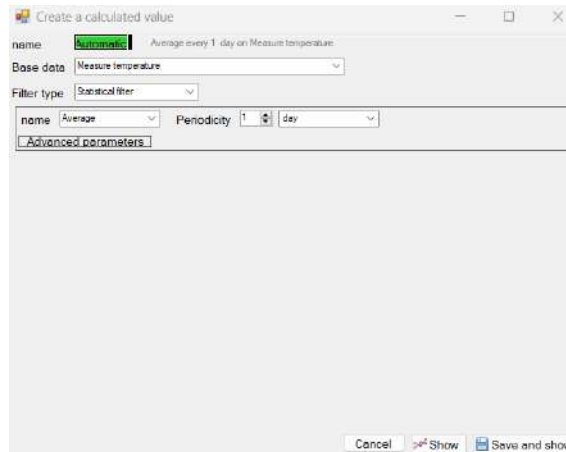
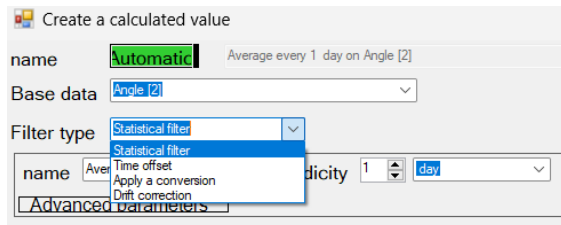

Edit window for a new calculated value - Calculation of the average daily temperature value





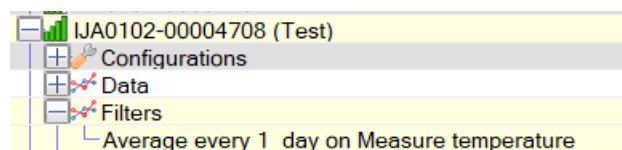







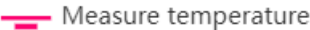

- Define contextual parameters based on the type of filter selected.
- Click “Save and show” to display the calculated value.

-> The calculated value appears in the saved data browser structure.



10.4. Data graph

10.4.1. Display tools on Avelour

	Used to invert the display of the selected data, the hidden data is displayed and the displayed data is hidden.
	Used to display the table of all data below the graph.
	Used to copy data to the clipboard so that you can paste it.
	Used to clear the graph data.
	Used to access the graph display customization window. See Customize the graph display
	Used to export data in different types (Excel, leme, CSV, etc.) to a directory.
 Measure temperature	The data label allows you to display/hide it with a click.
 Measure temperature	
	Switches between day (light) and night (dark) display mode.
	Used to zoom in on the graph: Click and hold to select the area to enlarge.
	Used to move the cursor on the graph: click, hold click and move.
	Hold down the mouse wheel button to activate grabber mode.
	Used to restore the initial display of the graph.
	Used to export the graph as a PNG image.
	X-axis Zoom cursor.

10.4.2. Show data graph

In the Saved data window:

- Double-click on the data or select multiple data elements, right-click and click "View" to view the data as a graph.

	6/11/202...	6/24/202...		
Configurations	6/21/202...	6/24/202...		
Data	6/20/202...	6/24/202...		
Counter	6/20/202...	6/21/202...	0022[...	255
Total rainfall	6/20/202...	6/21/202...	0035[...	255
H2S Concentra...	6/20/202...	6/24/202...	0038[...	1054
Meas...	6/20/202...	6/24/202...	0012[...	1054
Volta	6/20/202...	6/21/202...	0006[...	22
Volta	6/20/202...	6/21/202...	0006[...	22
Debu	6/20/202...	6/21/202...	0003[...	22
GSM	6/20/202...	6/21/202...	0017[...	22
Duration days	6/21/202...	6/21/202...	0046[...	1
Voltage [2]	6/21/202...	6/21/202...	0006[...	2
Filters	6/11/202...	6/11/202...		
File	6/20/202...	6/24/202...		

-> The saved data viewing window opens.

10.4.3. Customize the graph display

In the saved data viewing window:

- Click the configuration button  to display the graph display properties editing window.

Graph configuration
✕

DATA
AXES

Material height

+ Add a calculated data
- Remove data

Representation Type
 Line  Color

Unit
 mm

Symbol
 Aléatoire ?

Line type
 Standard

Filling

Line Width - 2 +

Linked axe : mm

Unbound axes

- 4 +
 Maximum fraction digits number

Round values

Graph configuration window

10.4.4. Hide the display of data on the graph

- To hide the display of a data item, click the data label at the top of the graph.

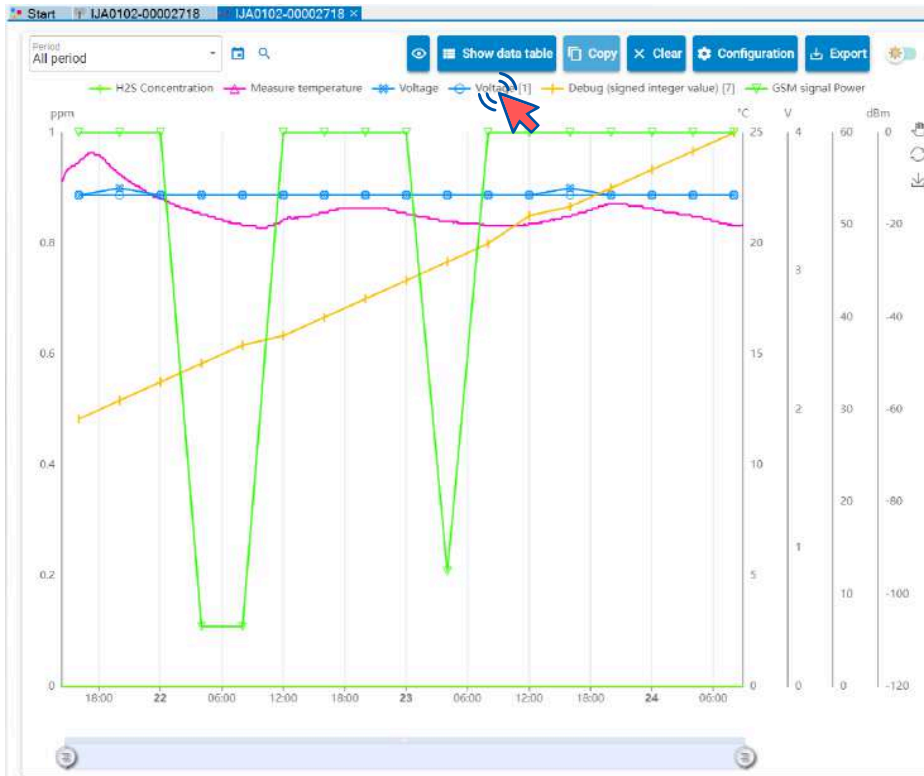

-> The data is no longer displayed on the graph and its label appears grayed out.

- Click the  button to invert the display, hide the displayed data and display the hidden data.

10.4.5. Display values in table form

In the saved data viewing window:

- Click the “Show data table” button.

-> Data are displayed below the graph.

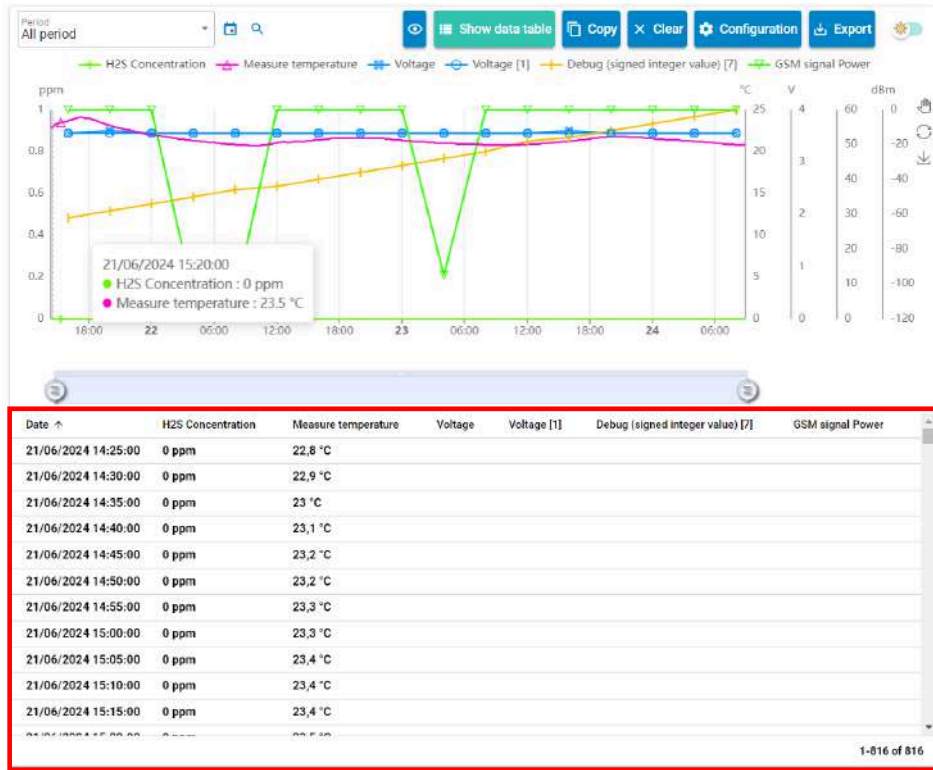

Data table

10.5. Export retrieved data



Data is retrieved in Avelour, see paragraph [Retrieving saved dataparameters](#).

- In the data viewing window, click on “Export”.
- Select the export type, the period and the export destination directory.

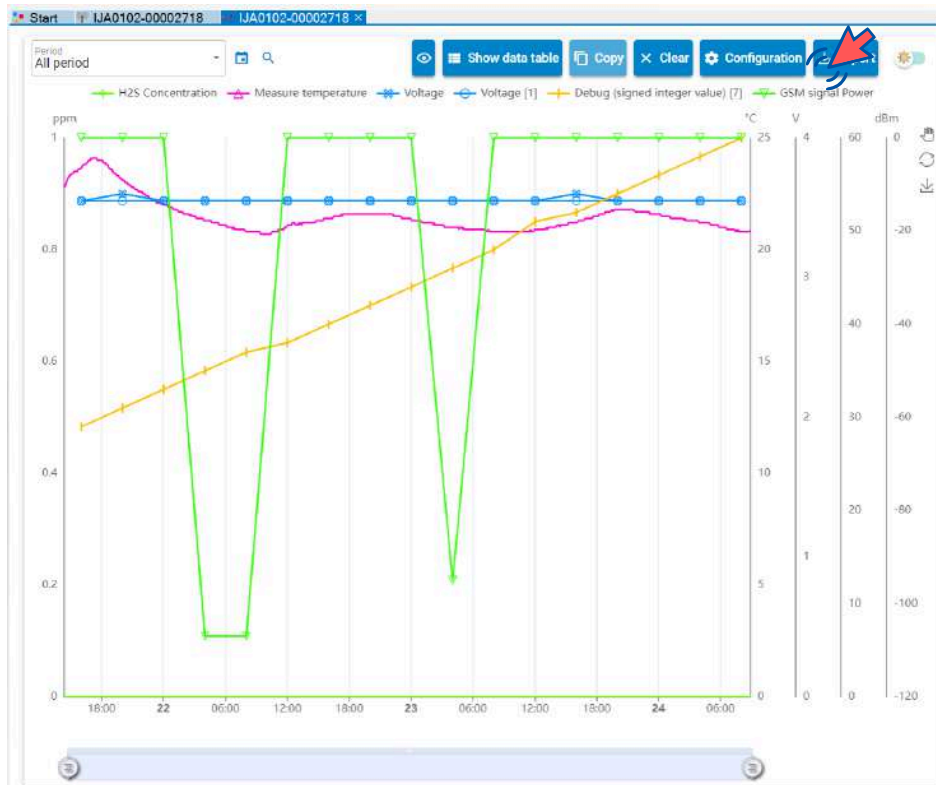

10.6. Delete data recorded on the logger

To delete data recorded on the logger memories:

- In the "Actions" menu, click "delete measures" to delete the main memory of the logger.

- In the "Actions" menu, click "delete measures" in the sub-menu "Auxiliary measures (for SMS)" to delete the auxiliary memory.

When connecting to a logger, if data is present, it is then possible to retrieve and delete data. The deleted data will then be that of the main memory.

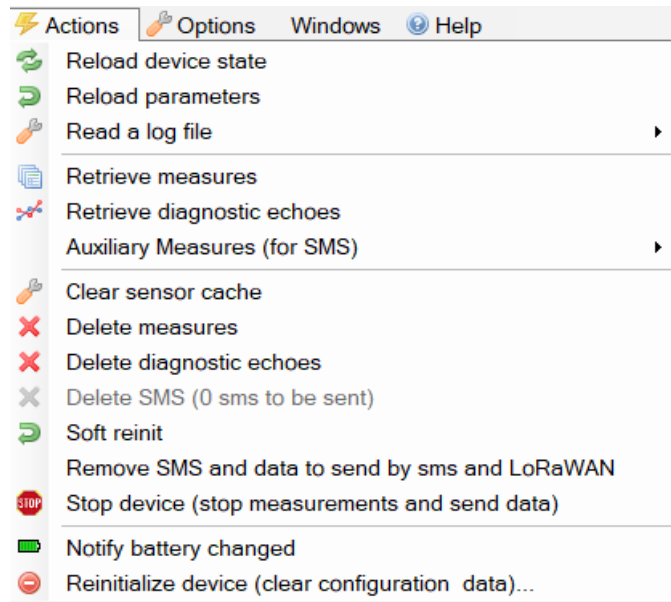

Chapter 11. Maintenance

In the event of a problem with an Ijinus logger or sensor, we recommend that you contact our after-sales department either by e-mail: sav@ijinus.fr or by telephone: +33 (0)298 090 332

You will be informed of the applicable procedure, so that you can either test the product yourself or return it to the factory for testing on our premises.

11.1. Replacing the battery

When the logger's battery is at the end of its life, a red banner appears on Avelour, inviting you to replace the battery.



Avoid leaving the logger open for too long (just a few minutes), because if the desiccant bag absorbs too much moisture, it will no longer be effective and will turn green.

- Unscrew the clamping ring (A) and remove the cover.
- Remove the battery and disconnect the circuit board.
- Check the color of the desiccant bags and replace them if they are green.
- Check the seal for damage.
- Check seal lubrication and if necessary, lubricate with neutral grease.
- Replace the cover as far as it will go, taking care to fit the insertion notch into the coded hole (B).

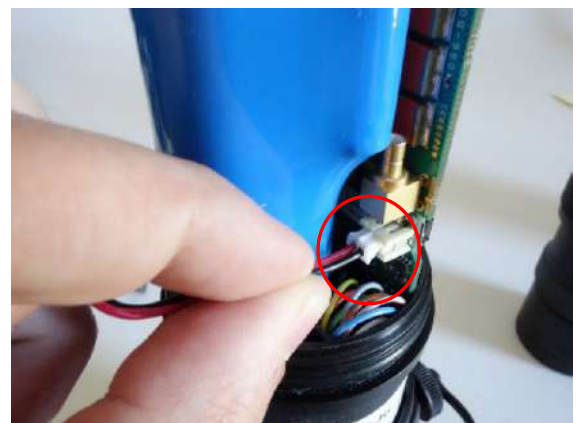

-> When the circuit board is restarted, the LED on the front of the board should flash red/green and then, after 2 to 3 minutes, only green every 10 seconds.

- In Avelour, click on "battery changed".

If the battery has been changed before the red banner appears, you must also record the battery change:

- Connect to the logger (see [Connecting to a logger](#)).
- In the actions menu, click on "report battery change" to restart the logger and return the energy gauge to 0.

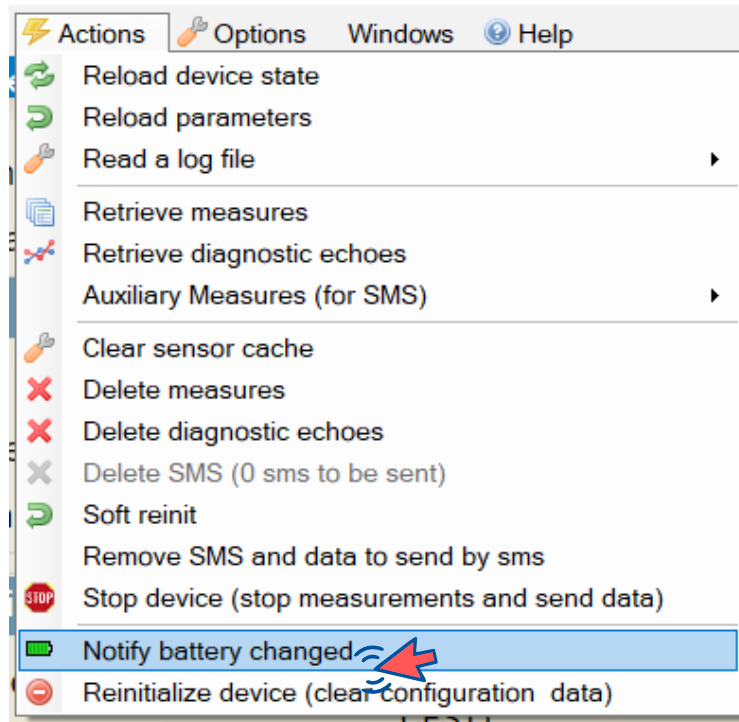

-> In the device properties window, the battery gauge changes to 0 mAh.

Diagnostic	
Date on device	2024-06-20 17:09:24 (+02h00 CEST)
Battery	3.6V
Gauge	0mAh
Free memory	1007200 / 3243616 (31%)
Aux data	1
Main data	0

11.2. Firmware update

A firmware update may be required when updating the Avelour programming software.

- Connect to the logger (see paragraph [Connecting to a logger](#)).
- In the "Options" menu, click on "Troubleshooting and errors".
- By connecting to the logger in advance, the choice of device (1) is already made. To change this choice, click "Device choice".
- In the list of actions to launch (2), select "Upgrade the device firmware".
- Click "Choose firmware".

-> The Firmware folder opens.

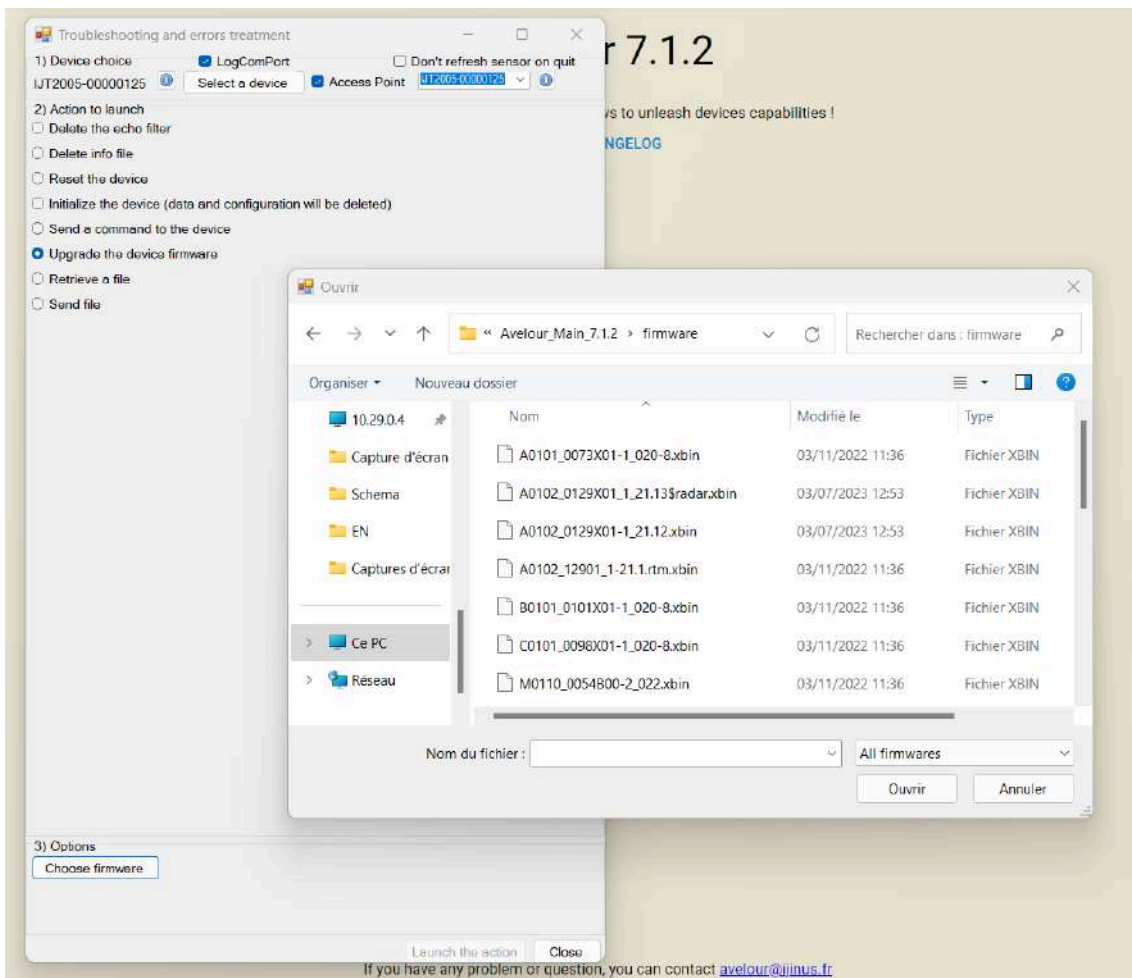

- Select the corresponding .xbin file and click "Launch the action" (3).

11.3. Remote firmware update



The logger must be equipped with a modem card and configured to send data via **FTP**, **HTTP** or **MQTT**.

If you are using the ijtrak server, contact Ijinus to obtain the identifiers and password and configure Avelour.

If using another server, contact Ijinus to obtain a version of Avelour enabling you to customize the server configuration.



Beware ! Remote firmware update and remote configuration can't be done simultaneously. Take care to launch one after the other.

- Hold down the CTRL key and select one or more loggers and right-click.
- Click on "Remote firmware update".

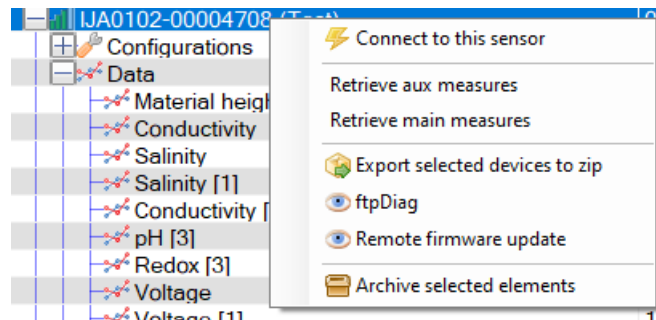

-> The update window opens and displays the firmware serial number(s), status, current version and new version.

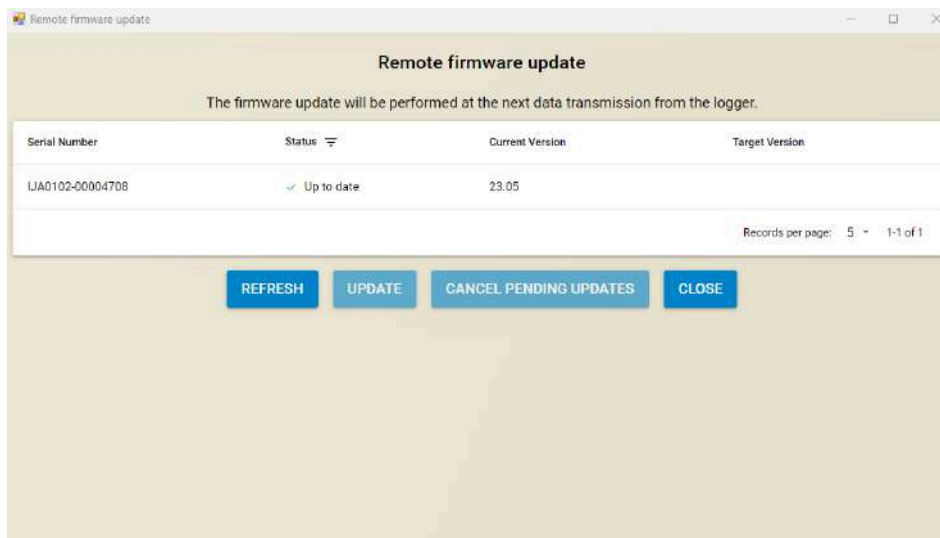

- Click "Update".

-> The update file is sent to the FTP server and the update will be performed during the next data transmission.

11.4. Reset the logger (factory settings)

The logger may need to be reset when a service request is made or if the password is forgotten.



The Reset process deletes all configuration files and data stored on the logger.

11.4.1. Wiji reset

- Connect to the logger (see [Connecting to a logger](#)).
- In the **Options** menu, click on **Diagnostics and errors**.
- Check that the serial number (1) corresponds to that of the logger.
- Check **Equipment reset (loss of data and configuration)** (2).
- Click on **Launch** (3).

-> the logger formatting window appears.



Depending on the amount of data to be deleted, the reset process may take a few minutes.

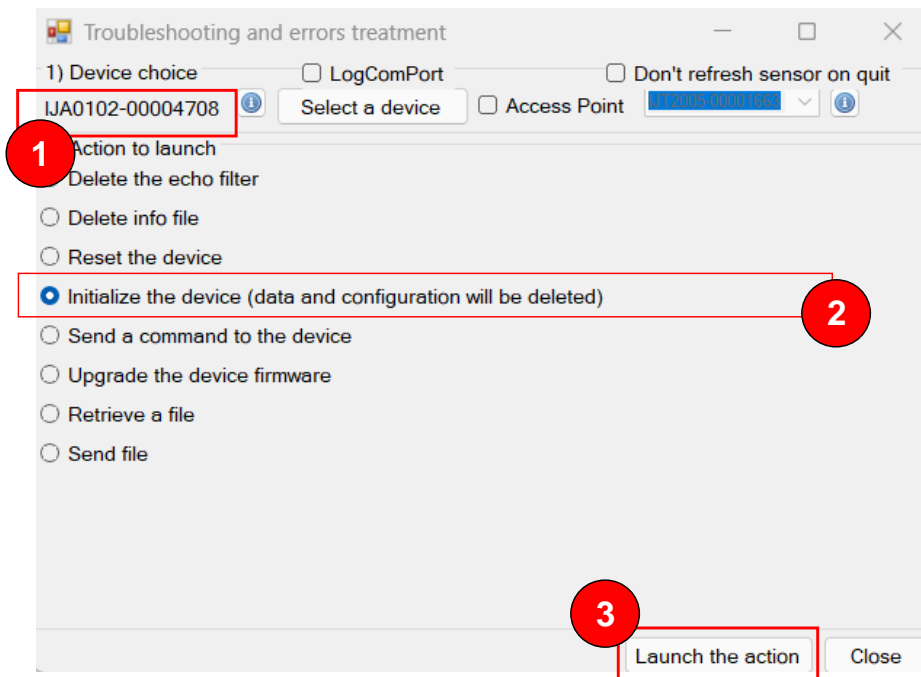

11.4.2. Manual reset



Avoid leaving the logger open for too long (just a few minutes), because if the desiccant bag absorbs too much moisture, it will no longer be effective and will turn green.



Removing the cover can be difficult due to the gasket. The cover antenna is connected to the circuit board, so to avoid pulling out the circuit board when opening the logger, we strongly advise you to open the logger as follows:

- Partially unscrew the clamping ring (approx. 2 turns).
- Pull on the cover until it is partially extracted, blocked by the clamping ring.
- Unscrew the clamping ring completely to fully remove the cover.
- To make it easier to press the buttons, we recommend removing the battery from its housing.
- Press the **SW (B)** button, then the **RST (A)** button, and release the **RST** button.
 - > The status LED (**C**) flashes red.
- When the LED changes to flashing green, release the **SW (B)** button.
 - > Reset starts.

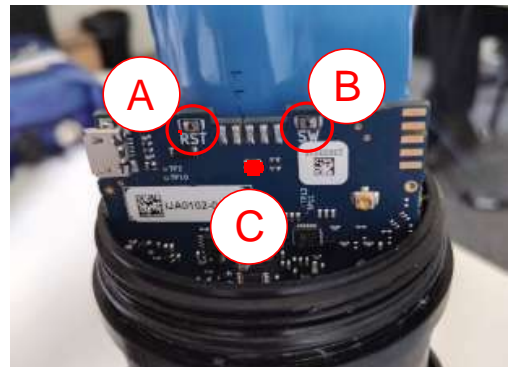

Depending on the amount of data to be deleted, the reset process may take a few minutes.

The LED resumes its initial flashing cycle (every 10 seconds in green) as soon as the reset is complete.